

# LUXEON FlipChip and LUXEON FlipChip UV

## Assembly and handling information

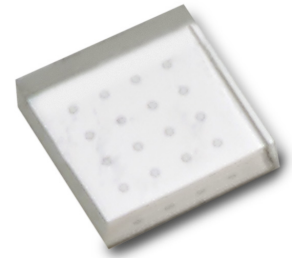

### Introduction

This application brief addresses the recommended assembly and handling procedures for LUXEON FlipChip and LUXEON FlipChip UV. Proper assembly and handling, as outlined in this application brief, ensures high optical output and long light output maintenance for LUXEON FlipChip and LUXEON FlipChip UV.

### Scope

The assembly and handling guidelines in this application brief apply to the following products with this part number designation as described below.

<b>LXF2-YZZZ1000NNNN1</b>	
Where:	
x -	designates packaging type (0 for die on blue bin tape, 1 for die on tape and reel)
y -	wavelength family (B for Royal Blue wavelength, U for Ultraviolet wavelength. See respective datasheet.)
zzz -	designates wavelength bin range (for Royal Blue — dominant wavelength bin, for Ultraviolet — peak wavelength bin. See respective datasheet.)
1000 -	designates die dimension (1000 for 1mm <sup>2</sup> )
nnnn -	esignates radiometric power bin range (0500 for 500mW min range. See respective datasheet.)

In the remainder of this document the term LUXEON FlipChip refers to any product in the LUXEON FlipChip product family.

# Table of Contents

Introduction .....	1
Scope .....	1
<b>1. LUXEON FlipChip Details .....</b>	<b>3</b>
1.1 Description .....	3
1.2 Optical Center and Property .....	3
1.3 Packaging .....	4
1.4 Handling Precautions .....	4
<b>2. LUXEON FlipChip Printed Circuit Board Design .....</b>	<b>5</b>
2.1 LUXEON FlipChip Footprint and Land Pattern .....	5
2.2 PCB Substrate Selection .....	5
2.3 Surface Finishing on Copper .....	6
2.4 Solder Mask .....	6
2.5 Silk Screen or Ink Printing .....	6
2.6 PCB Quality and Supplier .....	7
<b>3. Assembly Process .....</b>	<b>8</b>
3.1 Solder Paste .....	8
3.2 Stencil Printing .....	8
3.3 Die Attach (Pick and Place) .....	9
3.4 Pattern Recognition .....	10
3.5 Reflow .....	10
3.6 Flux Cleaning .....	11
3.7 Electrostatic Discharge Protection .....	12
<b>4. LED Package Component Assembly and Designing with Gold-Tin (AuSn) Solder .....</b>	<b>13</b>
4.1 PCB Footprint .....	13
4.2 Substrate Selection and Construction .....	14
4.3 Surface Finishing .....	14
4.4 Solder Paste .....	14
4.5 Stencil printing .....	14
4.6 Reflow .....	15
<b>About Lumileds .....</b>	<b>16</b>

# 1. LUXEON FlipChip Details

## 1.1 Description

LUXEON FlipChip is designed to be compatible with and best suited for surface mount technology (SMT) processing (Figure 1). The top finish of LUXEON FlipChip is sapphire (Figure 2). The solder pads on the bottom of LUXEON FlipChip are finished with under-bump metallization (UBM), consisting of standard copper-nickel-gold (Cu-Ni-Au) layers, with gold being the pad finishing. This pad configuration is not suitable to be used with silver attach epoxy method. The anode pad has a small notch in the center of the pad (Figure 2).

Section 4 discusses a special case where LUXEON FlipChip is intended to be assembled into a LED package component via gold-tin solder chip attach. This LED package may contain phosphor material and/or polymeric lens and is intended to be later assembled onto another PCB substrate, thus exposing LUXEON FlipChip to two times reflow.

When operating LUXEON FlipChip UV, proper safety precaution must be followed to protect eyes and skin from UV exposure.

## 1.2 Optical Center and Property

The theoretical optical center of LUXEON FlipChip coincides with the mechanical center of the chip. The sapphire substrate as shown in Figure 2 is visibly transparent and allows light to escape from the active layer (p-n junction) which is located at the base of the chip on which the anode and cathode pads are formed. Due to its construction, about 13% of the light is back scattered (reflected and refracted) behind the chip (Figure 3). In order to maximize light output extraction, the chip is mounted on a reflective surface. The reflectance spectrum of the surrounding surface will affect the chromaticity color point of LUXEON FlipChip.

When designing optical lens over LUXEON FlipChip UV, the lens material selected should be able to withstand prolonged UV exposure. For example, an untreated standard grade polycarbonate (PC) lens will absorb UV and turns yellowish over prolonged UV exposure and will reduce the light output performance of the whole LED system. Lumileds recommends customer to discuss the impact of UV light on lens material with lens suppliers.



Figure 1. Generic SMT process flow.

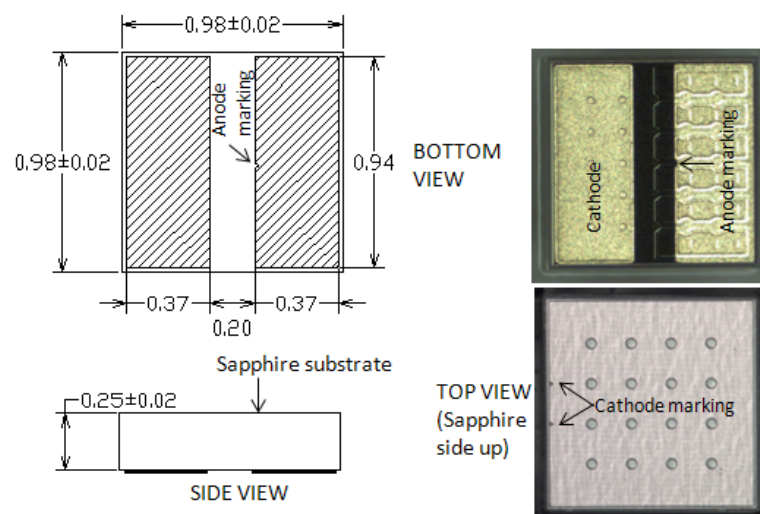

Figure 2. Relevant mechanical features (in mm) for LUXEON FlipChip and photos of LUXEON FlipChip showing the anode and cathode markings.

## 1.3 Packaging

LUXEON FlipChip is packaged, with the sapphire side up, on blue bin tape with protective cover sheet and sealed in an ESD (electrostatic discharge) bag. With the packaging label text of the bin tape in a reading orientation, the chips are orientated such that the cathode is positioned closest to the label and the long side of both electrode pads being parallel to the label text as shown in Figure 4.

Alternate packaging option is in tape and reel. Please refer to respective datasheet for option in packaging availability.

## 1.4 Handling Precautions

LUXEON FlipChip does not include any transient voltage suppressor (TVS) chip to protect the emitter against ESD. Appropriate precautions should therefore be taken when handling this device (see Section 3.7).

Any dust and debris on and around the sapphire may cause a decrease in light output.

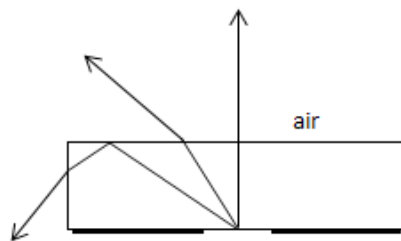

Figure 3. Ray tracing from LUXEON FlipChip. There is light being scattered behind the chip.

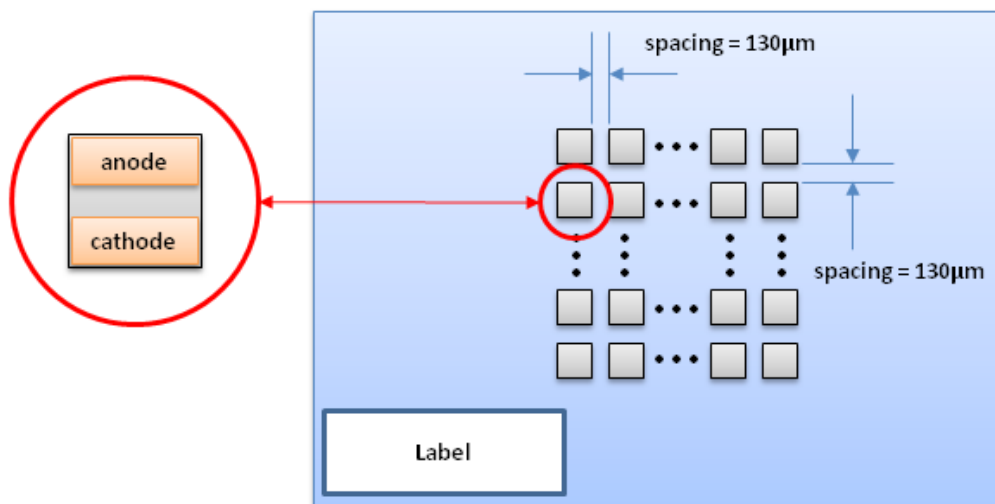

Figure 4. LUXEON FlipChip is packaged, sapphire side up, on blue bin tape. The bin tape contains 40 x 40 LUXEON FlipChip LEDs and includes a product label in one of the corners. LUXEON FlipChip LEDs are placed onto the bin tape such that the cathode is facing the product label on the bin tape.

## 2. LUXEON FlipChip Printed Circuit Board Design

LUXEON FlipChip is engineered to be surface mounted onto a ceramic, metal-core PCB (MCPCB) or FR4 substrate.

### 2.1 LUXEON FlipChip Footprint and Land Pattern

LUXEON FlipChip has two pads that need to be soldered onto corresponding pads on the PCB to ensure proper thermal and electrical operation. For optimum thermal performance, the copper area around the anode and cathode pads should be extended to maximize heat spreading into the PCB (Figure 5). Enlarging the solder mask area than the recommended size may affect the light output and color of the overall LUXEON FlipChip system.

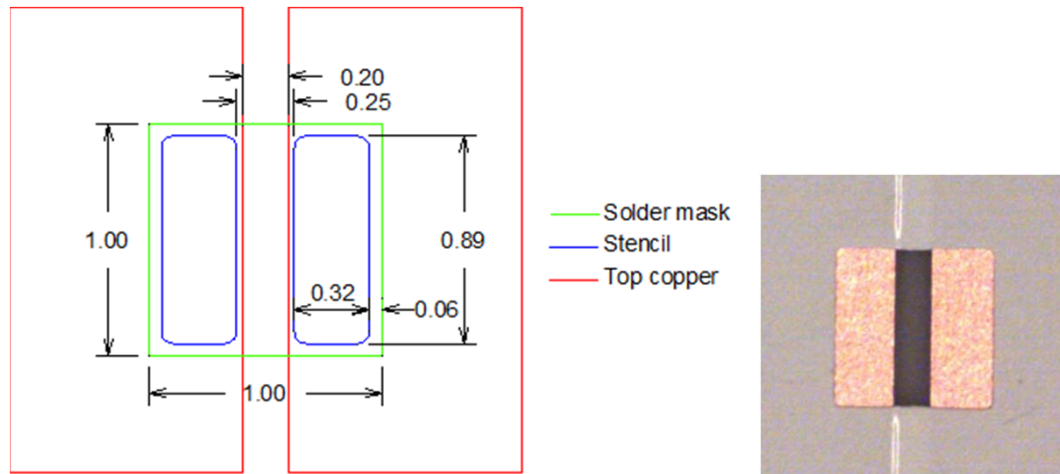

Figure 5. Recommended LUXEON FlipChip footprint design (left). Actual PCB footprint (right). All dimensions in mm.

### 2.2 PCB Substrate Selection

Table 1 provides a summary of the various performance characteristics of common PCB substrates to aid material selection.

Ceramic substrate provides the best matching of the coefficient of thermal expansion (CTE) with LUXEON FlipChip. Compared to Al MCPCB, a ceramic substrate may yield lower solder joint stress in applications where there are large variations in the substrate temperature. However, Lumileds has also successfully tested LUXEON FlipChip on Al MCPCB substrate using SAC 305 solder with the following MCPCB construction: 1mm thick aluminum core substrate (Al alloy 5052), 100 $\mu$ m thick dielectric layer with thermal conductivity of 3W/m-K, 1 oz top copper layer with electroless nickel immersion gold (ENIG) finish and white solder mask layer to improve surface reflectivity. Due to the higher CTE mismatch between LUXEON FlipChip and a MCPCB substrate, Lumileds recommends contacting the MCPCB vendor for suitable dielectric materials and/or perform necessary studies prior to final design.

**Table 1. General PCB substrate characteristics for consideration when designing boards for LUXEON FlipChip**

	<b>FR4</b>	<b>MCPCB</b>	<b>CERAMIC PCB</b>
Cost	Low to medium	Medium	High
PCB thermal conductivity performance	Very low to medium (for filled and capped vias)	Medium to excellent	High to excellent
Coefficient of thermal expansion (CTE)	Good CTE matching to LUXEON FlipChip	Moderate CTE matching to LUXEON FlipChip.	Good CTE matching to LUXEON FlipChip
LED assembly packing density (thermal resistance consideration)	Suitable for low density applications with large spacing between LEDs or operating at low drive current	Suitable for medium density applications with moderate spacing between LEDs	Suitable for high density applications with minimal spacing between LEDs.
Mechanical assembly and handling	Easy as board does not easily break	Easy as board does not easily break	Extra precaution to prevent ceramic breakage (hard and brittle)
Supplier availability	High	High	Limited

## 2.3 Surface Finishing on Copper

For small pad dimensions and pitch, Lumileds recommends using electroless nickel immersion gold (ENIG) or high temperature organic solderability preservative (OSP) on the exposed copper pads. Hot air solder leveling (HASL) should not be used because it yields poor co-planarity (leveling) and is, therefore, not suitable for fine pitch assembly such as LUXEON FlipChip.

## 2.4 Solder Mask

A suitable and stable white solder mask finish (typically a polymer compound with inert filler) with high reflectivity that typically meets most application needs. The white finish should not discolor over time when exposed to the desired operating temperature, back-scattered light, particularly from LUXEON FlipChip UV, or chemical pollutants as this may cause photo-thermal chemical degradation of polymers. Contact your PCB supplier to discuss various solder mask options.

## 2.5 Silk Screen or Ink Printing

We do not recommend putting any ink mark within and around the LUXEON FlipChip outline as the height of the ink may interfere with the LUXEON FlipChip rotation, tilt and solder stencil printing process. If needed, the ink printing should be at least 1mm away from the LUXEON FlipChip outline.

## 2.6 PCB Quality and Supplier

Select PCB suppliers that are capable of delivering the required level of quality. At a minimum the PCBs must be IPC compliant. IPC (Association Connecting Electronics Industries, [www.ipc.org](http://www.ipc.org)) is an association focusing on the printed board and electronic assembly industries. Examples of poor PCB quality include bumps/dimples on the soldering pads, missing metal, extra solder mask materials and contaminated solder pads.

A masking tolerance of 50 $\mu$ m or less between the copper trace pattern and solder mask is desirable to achieve optimum solder joint contact area. If the offset between the solder mask and the copper trace pattern is larger, one side of the electrode pads will have less solder joint contact area. This may affect package centering, and the thermal performance of LUXEON FlipChip and may increase the risk of solder bridging (resulting in electrical shorts). Figure 6 shows the solder pad sizes for three different misalignment levels between the copper trace pattern and the solder mask.



Figure 6. Diagram above shows the level of misalignment between the solder mask (green, for illustration only) and copper trace pattern (red). From left to right: no misalignment, 50 $\mu$ m misalignment and 100 $\mu$ m misalignment which will result in the left copper pad having 40% less exposed copper area than the right pad.

### 3. Assembly Process

LUXEON FlipChip is designed to be compatible to SMT process (Figure 1). A SMT process typically consists SMT components (LUXEON FlipChip), PCB substrate, solder paste, stencil, die attach machine (pick and place), solder heat reflow oven and flux clean machine or system. If the SMT components are ESD sensitive such as LUXEON FlipChip, ESD precautions are required.

#### 3.1 Solder Paste

Lumileds recommends a water soluble semiconductor grade, SAC305 solder paste (96.5% tin, 3% silver and 0.5% copper) of type 4 particle/powder size per JEDEC J-STD 005. An example is Alpha Advanced Materials WS 820 which has water soluble flux and can be cleaned with 60°C heated water. Before cleaning, always ensure that proper ESD precautions are taken. Note that flux residue near LUXEON FlipChip may discolor when exposed to high temperatures and light which may impact the light output and color performance of LUXEON FlipChip.

The no-clean solder paste actually leaves flux residue after reflow. It may also interact with encapsulation material such as silicone (if used to dispense around the LUXEON FlipChip) and may cause silicone browning over time.

#### 3.2 Stencil Printing

The recommended stencil thickness is 4mils (102µm). There are several important factors for consideration in obtaining good quality stencil printing (Figure 7). They are:

1. The aperture (stencil opening) wall should be smooth, free of debris, dirt or burr and have uniform thickness throughout the stencil plate.
2. Positional tolerance between the stencil plate and the PCB substrate must be small enough to ensure that the solder paste is not printed outside the footprint area. Hence both the stencil plate and the PCB must be secured properly.
3. The stencil plate must be flushed to the top of the solder mask using the recommended footprint design in Figure 5 during solder paste dispensing. Any large particles on top of the PCB may prevent a good contact between the stencil plate and PCB board.
4. The PCB substrate must be mechanically supported from the bottom to prevent PCB flexing when doing the stencil printing.

Using an automatic stencil printing machine with proper fiducials or guiding feature on the PCB and the stencil plate will yield the best accuracy and repeatability for the solder paste deposition process. Manual stencil printing process for small pad feature like LUXEON FlipChip is not recommended.

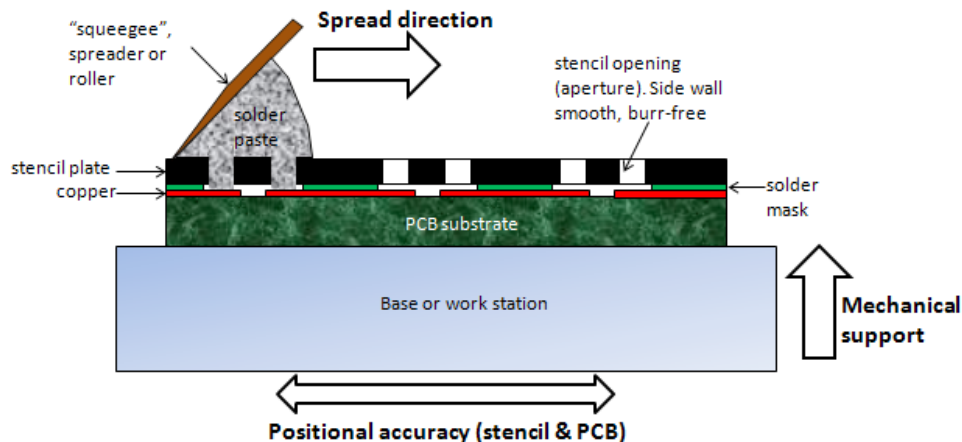

Figure 7. Stencil printing process.



### 3.3 Die Attach (Pick and Place)

Before starting the die attach process, check that the ESD precaution has been addressed.

Below are a few important points to consider when preparing for die attach:

1. Die attach collet selection. Since the top of the LUXEON FlipChip is made of sapphire which is a very hard material, most type of collet material will work. An inner collet diameter of 0.40mm with external collet diameter of 0.86mm was successfully evaluated by Lumileds. Always keep the tip of the collet free from debris and contamination.
2. Die attach ejector pin selection. Unlike the top of LUXEON FlipChip, the bottom (underneath the sapphire) is the epitaxial material where the p-n junction is located. It is not mechanically protected and can be damaged if a sharp and hard ejector pin material is used (Figure 8). Lumileds recommends an ejector pin with a plastic tip radius of 100mm to minimize the risk of mechanical damage. When setup properly, the ejector pin should not puncture through the tape. An example of a plastic tip ejector pin is made by Micro-Mechanics ([www.micro-mechanics.com](http://www.micro-mechanics.com)), part number SEN5-T07-170-010-20.
3. A die attach machine that can perform pattern recognition on the two bottom electrode pads will improve placement accuracy.

Figure 9 illustrates the proper setting for the die attach collet z-height mount. Care should be taken to prevent too much collet over-travel to avoid electrical shorting of pads after reflow.

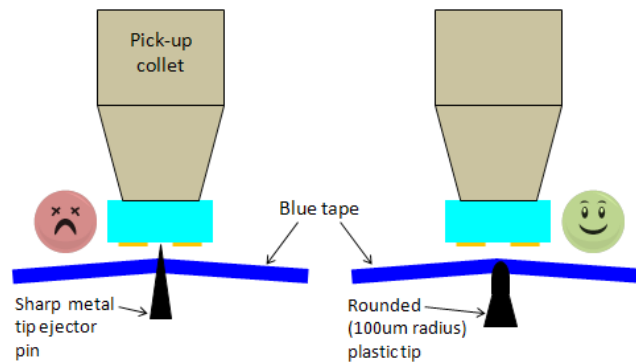

Figure 8. Sharp ejector pin tip may damage the LUXEON FlipChip (left). A rounded plastic tip minimizes the risk of damage caused by ejector pin (right).

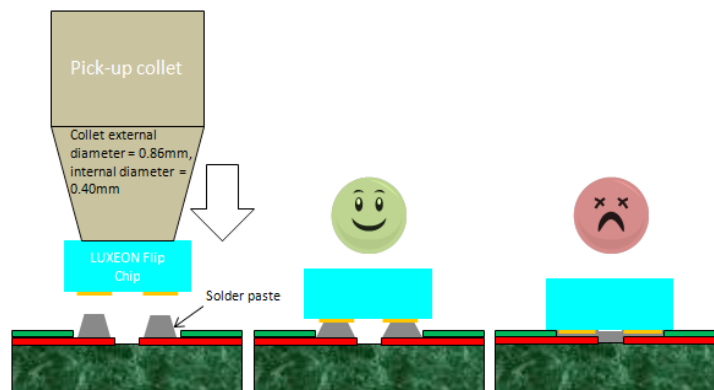

Figure 9. A proper starting point for the mounting z-height of LUXEON FlipChip is 2/3 of the stencil thickness against the top of the solder mask reference datum i.e. the collet should be in an under-travel position. Center picture shows the optimum result for the collet height setting. Right picture shows over-travel position and may result in bridging of the solder paste on adjacent pads prior to reflow, increasing the likelihood of electrical shorts.

### 3.4 Pattern Recognition

In order to achieve the best placement accuracy of LUXEON FlipChip on a PCB, Lumileds recommends that the die attach machine performs pattern recognition on the two electrode pads instead of the outline of LUXEON FlipChip.

### 3.5 Reflow

A standard SMT reflow temperature-time profile can be used to reflow LUXEON FlipChip on board. An example of the reflow condition and profile are shown in Figure 10 and Table 2.

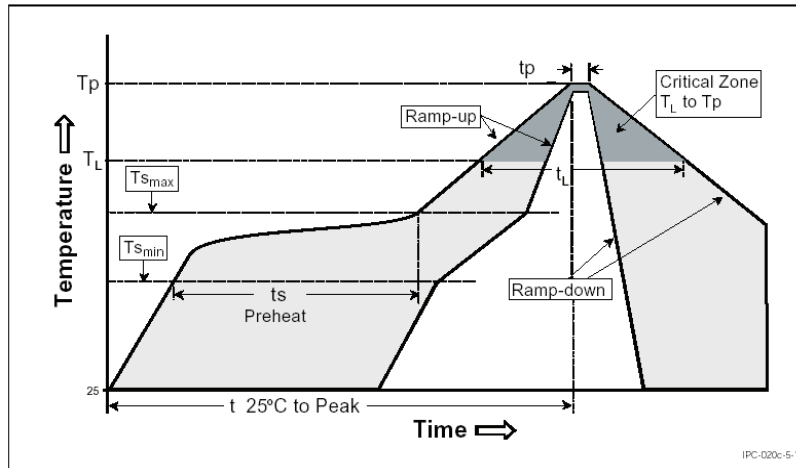

Figure 10. Solder reflow profile for Table 2.

Table 2. Reflow Temperature and Time Conditions for Figure 10

PROFILE FEATURE	LEAD FREE ASSEMBLY
Average Ramp-Up Rate ( $T_{s_{max}}$ to $T_p$ )	3°C/second max
Preheat Temperature Min ( $T_{s_{min}}$ )	150°C
Preheat Temperature Max ( $T_{s_{max}}$ )	200°C
Preheat Time ( $t_{s_{min}}$ to $t_{s_{max}}$ )	60–180 seconds
Liquidus Temperature ( $T_l$ )	217°C
Time Maintained Above Time ( $t_l$ )	60–150 seconds
Peak / Classification Temperature ( $T_p$ )	260°C
Time Within 5°C of Actual Peak Temperature ( $t_p$ )	20–40 seconds
Ramp - Down Rate	6°C/second max
Time 25°C to Peak Temperature	8 minutes max

Things to watch for after reflow:

1. Solder voids — perform x-ray inspection.
2. Any visible damage, tilt or placement of LUXEON FlipChip.
3. Solder mask change color — this may be an indication of poor quality solder mask or excessive temperature and time being used in the reflow process.
4. Functional test (open/short)

## 3.6 Flux Cleaning

It is important that the flux is removed from the PCB after reflow. Heated water (60°C) is recommended for effective flux removal. If not done correctly, any remaining flux may brown by interacting with other materials (e.g. silicone encapsulation and phosphor material) which are dispensed over the PCB and LUXEON FlipChip. Remaining flux may also affect the PCB substrate reflectivity, which, in turn, affects the color and light output of LUXEON FlipChip.

Before doing any water cleaning, make sure that ESD precautions are in place. Some examples of protecting LUXEON FlipChip from ESD damage during cleaning are:

1. Attaching transient voltage suppressor (TVS) protection diode first in parallel to the LUXEON FlipChip (Figure 11).
2. When using deionized (DI) water, ensure that the DI water has some soluble ions to reduce the water resistivity and prevent static build-up by using a carbon dioxide (CO<sub>2</sub>) bubbler in DI water system. Note: too much soluble ions can lead to metal (galvanic) corrosion.
3. Having the LUXEON FlipChip anode and cathode temporarily at the same electrical potential by shorting the contacts (Figure 11). When doing this, it is important that LUXEON FlipChips have no residual charges in it (static build-up), otherwise shorting could actually damage the chips. By practicing safe ESD process during all stages of handling will minimize static build up.

Figure 11 shows three different electrical schematics to protect the LUXEON FlipChip from ESD damage. The middle option employs permanent TVS diode while the left and right options are temporary solutions via shorting the LUXEON FlipChip electrodes. The shorted path must later be removed while still maintaining safe ESD practice during assembly and handling of LUXEON FlipChip.

An example (Figure 12) of a flux cleaning system consists of a high pressure water jet with each LUXEON FlipChip already protected via TVS chip.

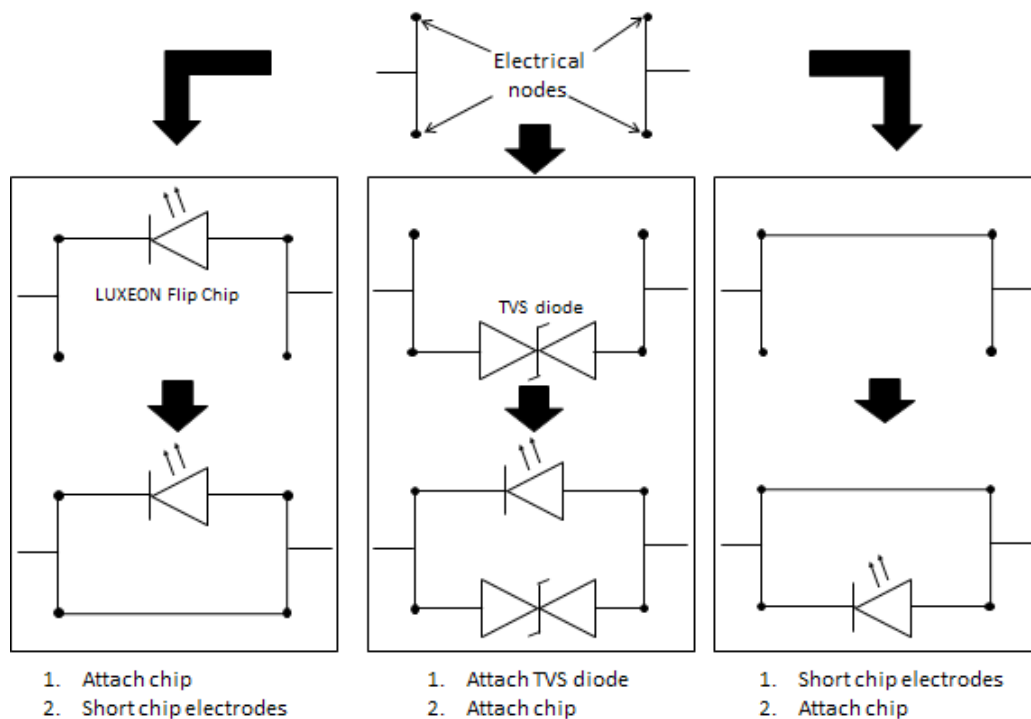

Figure 11. Electrical schematics showing three different methods of ESD protection. The middle picture provides permanent ESD protection while left and right pictures are temporary solution.

## 3.7 Electrostatic Discharge Protection

LUXEON FlipChip does not include any transient voltage suppressor (TVS) chip to protect against ESD. A LUXEON FlipChip which is damaged by ESD may not light up at low currents and/or may exhibit abnormal performance characteristics such as a high reverse leakage current, and a low forward voltage. Latent ESD damage (no immediate failure symptom but partially damage and may degrade over time) is difficult to detect, hence safe ESD practice is needed at all times during the handling and assembly process.

Lumileds recommends that the workplace is setup per the recommendations given in JEDEC standard document JESD625B "Requirements for Handling Electrostatic-Discharge-Sensitive (ESDS) Devices" or IEC 61340-5-1,2 and 3 documents and that operators are properly trained to handle LUXEON FlipChip according to the ESD classification of the device. Some common ESD guidelines when handling LUXEON FlipChip:

- Any handling or assembly of boards containing unprotected (no TVS) chips must be done in the designated ESD protected areas and workstations as described in JESD625B.
- Always wear conductive wrist straps that is continuously monitored when working or handling assembled boards containing unprotected chips.
- Use an ion blower to neutralize the static discharge that may build up on the surface of the LUXEON FlipChip during storage and handling.
- Always keep unused LUXEON FlipChip in the protective ESD storage bag.

Depending on the final application, it may be necessary to include additional ESD protection, such as a TVS protection diode on the substrate on which LUXEON FlipChip is reflowed.

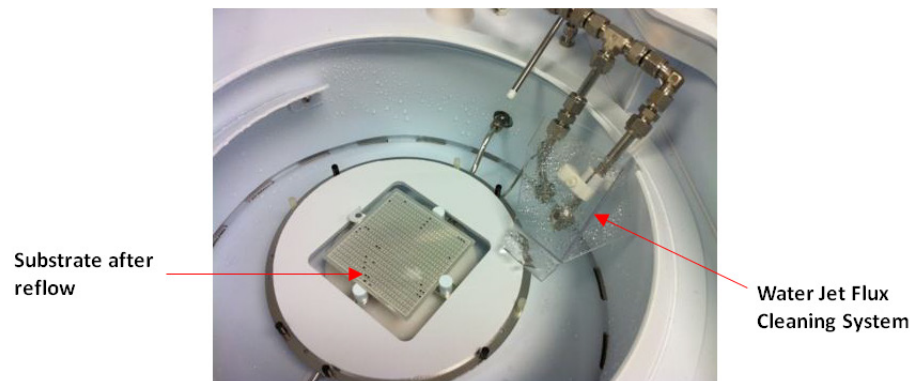

Figure 12. A water jet system can be used to remove any flux residue.

## 4. LED Package Component Assembly and Designing with Gold-Tin (AuSn) Solder

When LUXEON FlipChip is assembled into an LED package component which subsequently needed to be placed onto another substrate for a second reflow (see Figure 13), the solder used to attach the chip must not turn into liquid state (melting) during that process. If it does, the solder joint quality may be compromised. Hence a higher solder alloy melting point temperature must be used for such application. Lumileds recommends using gold-tin (AuSn) solder paste with 80%/20% gold to tin weight ratio with melting point of 280°C which is higher than SAC305 melting point (217°C). This section specifically focuses on assembly and designing of LUXEON FlipChip using AuSn solder alloy.

### 4.1 PCB Footprint

Copper layout is similar to Figure 5 but without the solder mask (Figure 14).

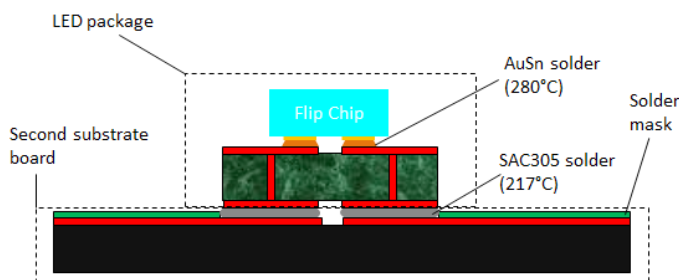

Figure 13. LED package using LUXEON FlipChip already attached to the first substrate via AuSn solder which subsequently attached to the second substrate board via SAC305. The first solder system (AuSn) has higher melting point. Note that no solder mask is used on the LED package substrate.

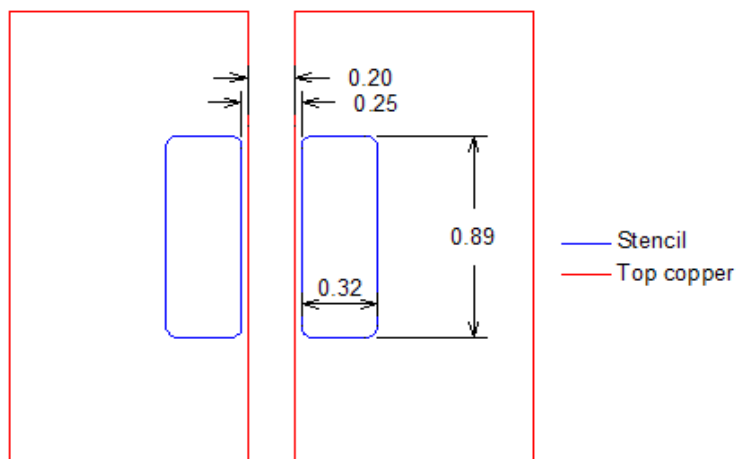

Figure 14. Recommended LUXEON FlipChip footprint design for LED package design.

## 4.2 Substrate Selection and Construction

For good overall thermal performance, ceramic substrate such as alumina (Al<sub>2</sub>O<sub>3</sub>) or aluminum nitride (AlN) (more expensive but better thermal) is recommended. The top metal stack where LUXEON FlipChip is to be attached is made up copper layer on ceramic follows by 2.5 to 7.5µm of nickel (Ni) and a minimum of 2.0µm of silver (Ag) reflecting surface (Figure 15). To simplify PCB manufacturing, the bottom metallization can have the same Cu-Ni-Ag metal stack. Solder mask is not needed since the AuSn solder does not easily spread out over the silver surface during reflow.

Figure 15 shows two possible ceramic PCB cross section designs. The top left has two bottom pads and the top right has three bottom pads where the center is an electrically isolated thermal pad. The latter design can be engineered to have better thermal performance but may require larger footprint and also has the advantage if high electrical isolation is needed for a direct metal heat sink attach.

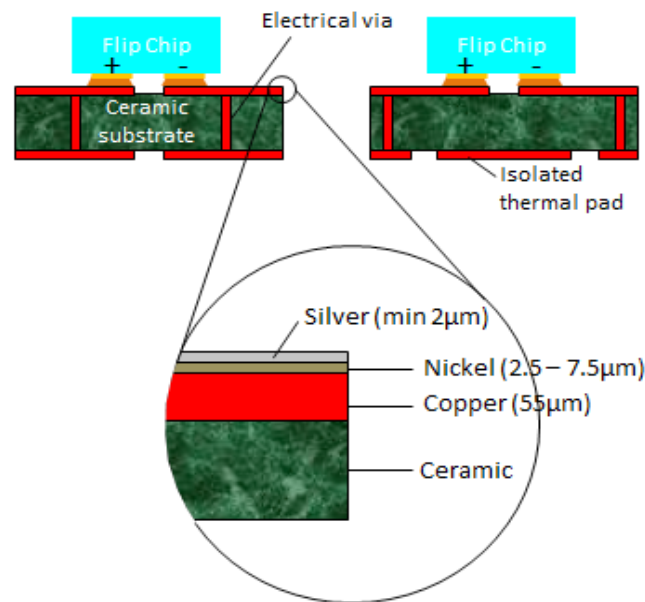

Figure 15. Ceramic PCB cross sections and metal stacks.

## 4.3 Surface Finishing

Care should be taken when storing and handling silver plated surfaces. Avoid touching with fingers, storing with other materials that contain or emit sulfur such as galvanized rubber or exposed to outside air which may have high content of hydrogen sulfide from fossil burning.

## 4.4 Solder Paste

Lumileds has successfully tested AuSn water soluble solder paste from Indium Corporation. The part number is Indium 3.2, Type 5, 93% with water soluble flux. Please contact Indium Corporation for further information and ordering. Flux cleaning is done using heated water at 60°C (see section 3.6 on flux cleaning).

## 4.5 Stencil printing

A 50µm thick stencil thickness is used for AuSn solder paste printing.

## 4.6 Reflow

To minimize surface oxidation rate of metals at higher reflow temperature, a reflow oven equipped with nitrogen flow can improve the quality of the solder joint formed. A 500ppm of oxygen concentration or less is sufficient to achieve this.

The AuSn reflow temperature profile depends on various factors such as oven configuration and total heat mass to reflow. Figure 16 shows the typical reflow temperature profile which has been successfully used by Lumileds using the recommended solder paste from Indium Corporation.

Note that if a TVS diode is to be used, it must be attached and reflowed in parallel with LUXEON FlipChip using the same AuSn solder system.

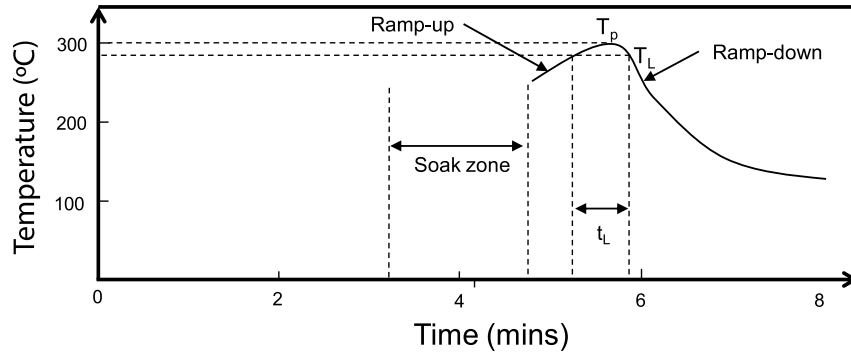

PROFILE FEATURE	AuSn ASSEMBLY
Soak zone	
- Temperature	250 ±5°C
- Time	60 to 80 seconds
Liquidus temperature ( $T_L$ )	280°C
Ramp-up	Approximately 1°C/second
Time above $T_L$ ( $t_L$ )	30 to 40 seconds
Peak temperature ( $T_p$ )	300 ±3°C
Ramp-down	3.3°C/second max

Figure 16. Typical AuSn reflow temperature profile.

## About Lumileds

Lumileds is the light engine leader, delivering innovation, quality and reliability.

For 100 years, Lumileds commitment to innovation has helped customers pioneer breakthrough products in the automotive, consumer and illumination markets.

Lumileds is shaping the future of light with our LEDs and automotive lamps, and helping our customers illuminate how people see the world around them.

To learn more about our portfolio of light engines, visit [lumileds.com](http://lumileds.com).



©2015 Lumileds Holding B.V. All rights reserved.  
LUXEON is a registered trademark of the Lumileds Holding B.V.  
in the United States and other countries.

[lumileds.com](http://lumileds.com)

Neither Lumileds Holding B.V. nor its affiliates shall be liable for any kind of loss of data or any other damages, direct, indirect or consequential, resulting from the use of the provided information and data. Although Lumileds Holding B.V. and/or its affiliates have attempted to provide the most accurate information and data, the materials and services information and data are provided "as is," and neither Lumileds Holding B.V. nor its affiliates warrants or guarantees the contents and correctness of the provided information and data. Lumileds Holding B.V. and its affiliates reserve the right to make changes without notice. You as user agree to this disclaimer and user agreement with the download or use of the provided materials, information and data.