

Type 2 surge protection plug - VAL-MS 750/30-ST - 2920256

Please be informed that the data shown in this PDF Document is generated from our Online Catalog. Please find the complete data in the user's documentation. Our General Terms of Use for Downloads are valid (<http://phoenixcontact.com/download>)



Type 2 surge protection plug with a varistor for VAL-MS base element, thermal monitoring, visual fault warning.
Design: 750 V AC

Product Features

- ✓ Single-channel, DIN-rail mountable protective devices
- ✓ Disconnect device on each individual plug
- ✓ Mechanical coding of all slots
- ✓ Consists of base element and plug
- ✓ Optical, mechanical status indication for the individual arresters
- ✓ Base element with/without floating remote indication contact



Key commercial data

Packing unit	1 pc
Weight per Piece (excluding packing)	80.0 GRM
Custom tariff number	85363030
Country of origin	Germany

Technical data

Dimensions

Height	52.4 mm
Width	17.5 mm
Depth	55.3 mm

Ambient conditions

Degree of protection	IP20
Ambient temperature (operation)	-40 °C ... 80 °C
Ambient temperature (storage/transport)	-40 °C ... 80 °C
Altitude	≤ 2000 m (amsl (above mean sea level))

Type 2 surge protection plug - VAL-MS 750/30-ST - 2920256

Technical data

Ambient conditions

Permissible humidity (operation)	5 % ... 95 %
Shock (operation)	25g
Vibration (operation)	5g

General

Standards/specifications	IEC 61643-11 2011
	EN 61643-11 2012
IEC test classification	II
	T2
EN type	T2
SPD design	Voltage-limiting type
Mode of protection	L-PEN
	L-PE
Mounting type	On base element
Color	black
Housing material	PA 6.6
Pollution degree	2
Distance between live and grounded parts	8 mm
Inflammability class according to UL 94	V-0
Type	Male
Number of positions	1
Surge protection fault message	Optical

Additional descriptions

Note	Usable in all low-voltage systems between L-N or L-PEN. Only usable in IT Systems between L-PE, if the exposed-conductive-parts (bodies) of the equipment of the low-voltage installation is connected to the earthing arrangement of the transformer substation. (interconnected earthing arrangement of the HV-transformer substation with the bodies of the LV-installation. $R_E = R_A$ accordance to IEC 60364-4-442 / VDE 0100-442 Fig. 44D / Example a)
------	---

Protective circuit

Nominal voltage U_N	554/960 V AC (TN)
	690 V AC (IT)
Nominal frequency f_N	50 Hz (60 Hz)
Maximum continuous operating voltage U_C	760 V AC
Residual current I_{PE}	≤ 0.5 mA
Standby power consumption P_C	≤ 400 mVA
Nominal discharge current I_n (8/20) μ s	15 kA
Maximum discharge current I_{max} (8/20) μ s	30 kA

Type 2 surge protection plug - VAL-MS 750/30-ST - 2920256

Technical data

Protective circuit

Short-circuit current rating I_{SCCR}	25 kA
Voltage protection level U_p	≤ 2.9 kV
Residual voltage U_{res}	≤ 2.9 kV (at I_n)
	≤ 2.7 kV (at 10 kA)
	≤ 2.5 kV (at 5 kA)
	≤ 2.3 kV (at 3 kA)
TOV behavior at U_T	1000 V AC (5 s / withstand mode)
Response time t_A	≤ 25 ns
Max. backup fuse with branch wiring	100 A AC (gG)

Connection data

Connection method	VALVETRAB plug-in system
-------------------	--------------------------

UL specifications

UL class	Type 4 SPD for Type 2 applications
Maximum continuous operating voltage MCOV (L-N)	750 V AC
Nom. voltage	690 V AC
Mode of protection	L-G
Power distribution system	1
Nominal frequency	50/60 Hz
Voltage protection rating VPR (L-N)	2.5 kV
Nominal discharge current I_n (L-N)	10 kA

Classifications

eCl@ss

eCl@ss 4.0	27140201
eCl@ss 4.1	27130801
eCl@ss 5.0	27130801
eCl@ss 5.1	27130801
eCl@ss 6.0	27130805
eCl@ss 7.0	27130805
eCl@ss 8.0	27130805

ETIM

ETIM 2.0	EC000941
ETIM 3.0	EC000941
ETIM 4.0	EC000941

Type 2 surge protection plug - VAL-MS 750/30-ST - 2920256

Classifications

ETIM

ETIM 5.0	EC000941
----------	----------

UNSPSC

UNSPSC 6.01	30212010
UNSPSC 7.0901	39121610
UNSPSC 11	39121610
UNSPSC 12.01	39121610
UNSPSC 13.2	39121620

Approvals

Approvals

Approvals

KEMA-KEUR / ÖVE / CCA / IEC EE CB Scheme / UL Recognized / cUL Recognized / GOST / GL / KEMA-KEUR / ÖVE / CCA / IEC EE CB Scheme / cULus Recognized

Ex Approvals

Approvals submitted

Approval details

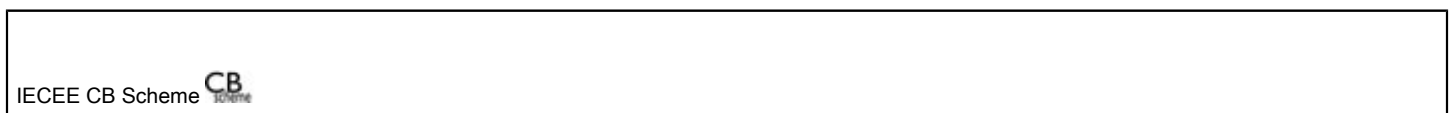
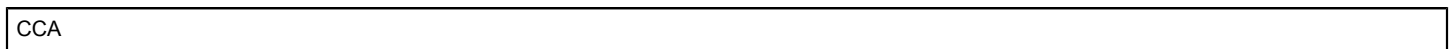
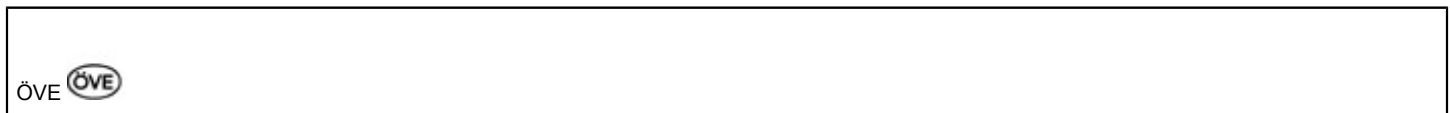
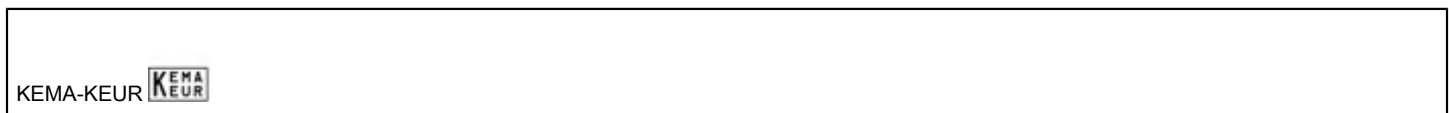

Type 2 surge protection plug - VAL-MS 750/30-ST - 2920256

Approvals

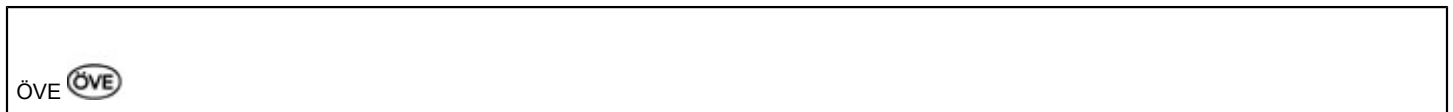
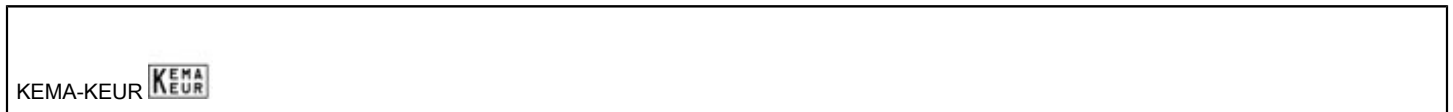
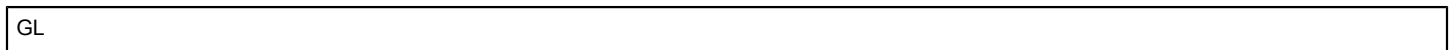

Drawings

Type 2 surge protection plug - VAL-MS 750/30-ST - 2920256

Dimensioned drawing

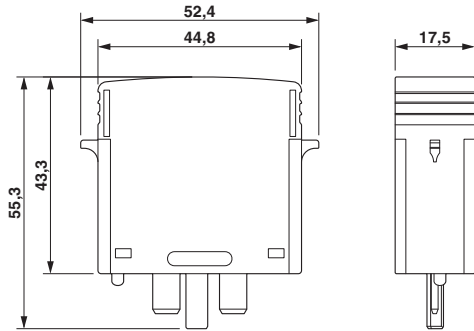

Circuit diagram

