

**Serial EEPROM Series Standard EEPROM
WLCSP EEPROM**



BU9829GUL-W (16Kbit)

● **General Description**

BU9829GUL-W is Serial EEPROM built-in LDO regulator by SPI BUS interface.

● **Features**

○ EEPROM PART

- 2,048 words × 8 bits architecture serial EEPROM
- Wide operating voltage range (1.6V to 3.6V)
- Serial Peripheral Interface
- Self-timed write cycle with automatic erase
- Low Power consumption
 - Write (3.6V) : 1.5mA (Typ.)
 - Read (3.6V) : 0.5mA (Typ.)
 - Standby (3.6V) : 0.1μA (Typ.)
- Auto-increment of registers address for Read mode
- 32 byte Page Write mode
- DATA security
 - Defaults to power up with write-disabled state
 - Software instructions for write-enable/disable
 - Block writes protection by status register
 - Write inhibit at low Vcc
- Initial data FFh in all address, 00h in status register and 10 in VSET [1:0].
- Data retention: 10 years
- Endurance : 100,000 erase/write cycles

○ OLDO REGULATOR PART

- Low power consumption
 - Standby (3.6V) : 0.1 μA (Typ.)
 - Operation (3.6V) : 0.1mA (Typ.)
- Power on/off by enable pin
- Initial LDO output voltage 2.9V
- Setting output voltage by EEPROM command (VSET WRITE)

● **Package W(Typ.) x D(Typ.) x H(Max.)**



● **Typical Application Circuit**

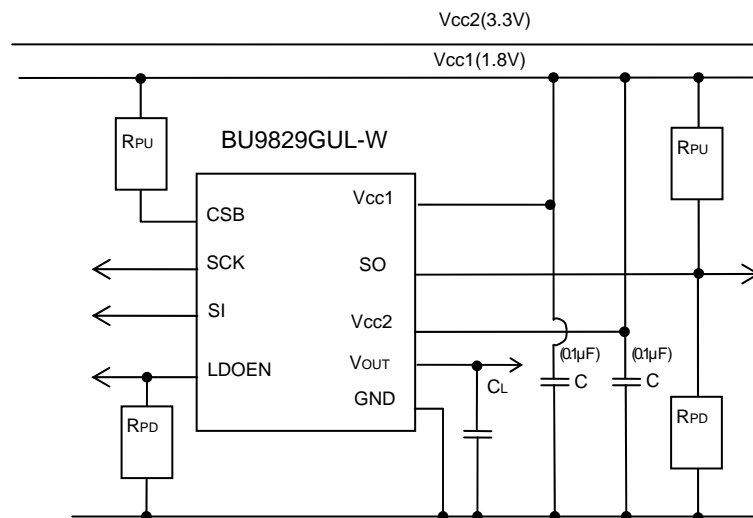

○ Product structure : Silicon monolithic integrated circuit ○ This product is not designed protection against radioactive rays

●Block Diagram

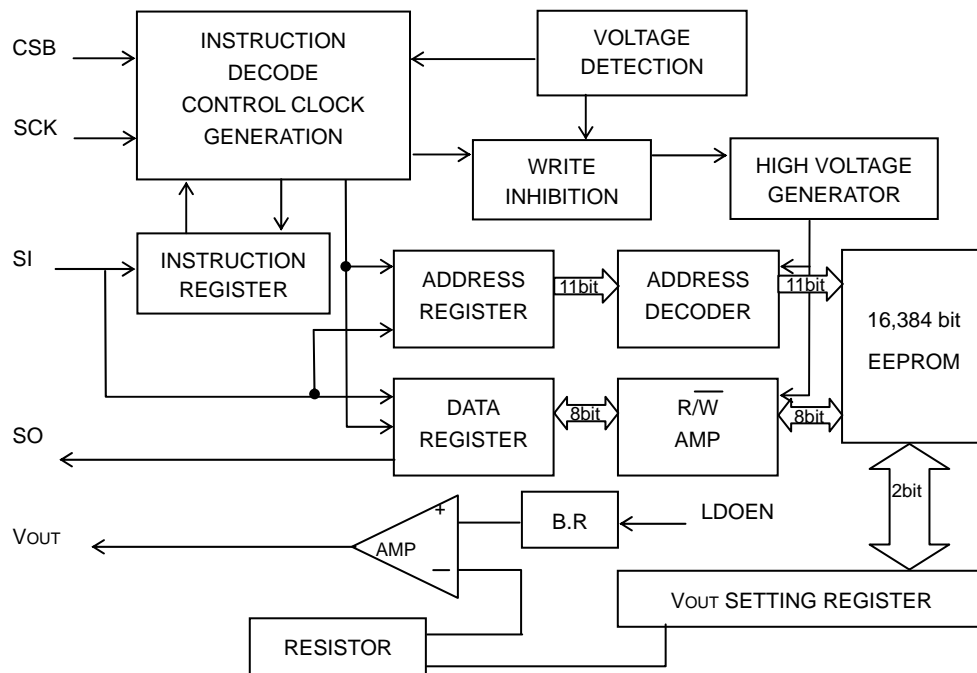

●Pin Configuration

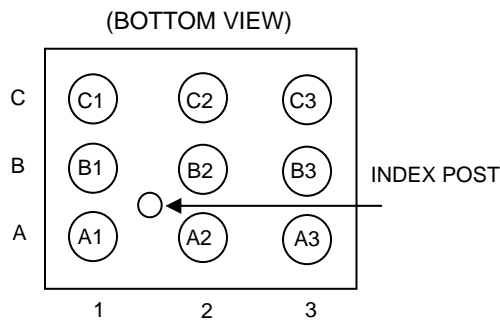

●Pin Descriptions

Land No.	Pin Name	I/O	Function
A1	Vcc1	—	Power Supply (EEPROM)
A2	CSB	IN	Chip Select Control
A3	SCK	IN	Serial Data Clock Input
B1	Vcc2	—	Power Supply (LDO)
B2	SI	IN	Start Bit, Op.code, Address, Serial Data Input
B3	SO	OUT	Serial Data Output
C1	V _{OUT}	OUT	LDO Regulator Output
C2	GND	—	Ground (0V)
C3	LDOEN	IN	LDO Regulator Enable

● Absolute Maximum Ratings (Ta=25°C)

Parameter	Symbol	Rating	Unit	Remarks
Supply Voltage	Vcc1(EEPROM)	-0.3 to 4.5	V	
	Vcc2(LDO)			
Power Dissipation	Pd	220	mW	When using at Ta=25°C or higher, 2.2mW to be reduced per 1°C
Storage Temperature	Tstg	-65 to 125	°C	
Operating Temperature	Topr	-30 to 85	°C	
Terminal Voltage	—	-0.3 to Vcc+0.3	V	

● Memory cell characteristics (Ta=25°C, Vcc1=1.6V to 3.6V)

Parameter	Limits			Unit
	Min.	Typ.	Max.	
Write/Erase Cycle *1	100,000	—	—	Times
Data Retention *1	10	—	—	Year

*1 : Not 100% tested

● EEPROM Recommended Operating Ratings

Parameter	Symbol	Rating	Unit
Supply Voltage	Vcc1	1.6 to 3.6	V
Input Voltage	VIN	0 to Vcc1	

● LDO regulator Recommended Operating Ratings

Parameter	Symbol	Rating	Unit
Supply Voltage	Vcc2	2.9 to 3.6	V
Input Voltage	VIN	0 to Vcc2	

● Input/output capacity (Ta=25°C, Frequency=5MHz)

Parameter	Symbol	Limits		Unit	Conditions
		Min.	Max.		
Input Capacitance *1	CIN	—	8	pF	VIN=GND
Output Capacitance *1	COU	—	8	pF	VOUT=GND

*1:Not 100% TESTED

● EEPROM DC operating characteristics (Unless otherwise specified, Ta=-30°C to 85°C, Vcc1=1.6V to 3.6V)

Parameter	Symbol	Limits			Unit	Test condition
		Min.	Typ.	Max.		
"H" Input Voltage1	VIH1	0.7xVcc1	—	Vcc1+0.3	V	2.5 ≤ Vcc1 ≤ 3.6V
"H" Input Voltage2	VIH2	0.75xVcc1	—	Vcc1+0.3	V	1.6 ≤ Vcc1 < 2.5V
"L" Input Voltage1	VIL1	-0.3	—	0.3xVcc1	V	2.5V ≤ Vcc1 ≤ 3.6V
"L" Input Voltage2	VIL2	-0.3	—	0.25xVcc1	V	1.6V ≤ Vcc1 < 2.5V
"L" Output Voltage1	VOL1	0	—	0.2	V	IOL=1.0mA, 2.5V ≤ Vcc1 ≤ 3.6V
"L" Output Voltage2	VOL2	0	—	0.2	V	IOL=1.0mA, 1.6V ≤ Vcc1 < 2.5V
"H" Output Voltage1	VOH1	Vcc1-0.2	—	Vcc1	V	IOH=-0.4mA, 2.5V ≤ Vcc1 ≤ 3.6V
"H" Output Voltage2	VOH2	Vcc1-0.2	—	Vcc1	V	IOH=-100μA, 1.6V ≤ Vcc1 < 2.5V
Input Leakage Current	ILI	-1	—	1	μA	VIN=0 to Vcc1
Output Leakage Current	ILO	-1	—	1	μA	VOUT=0 to Vcc1, CSB=Vcc1
Operating Current Write	ICC1	—	—	1.5	mA	Vcc1=1.8V, fSCK =2MHz, tE/W=5ms Byte Write, Page Write, Write Status Register
	ICC2	—	—	2.0	mA	Vcc1=2.5V, fSCK =5MHz,tE/W=5ms Byte Write, Page Write, Write Status Register
Operating Current Read	ICC3	—	—	0.2	mA	Vcc1=1.8V, fSCK=2MHz, SO=OPEN Read, Read Status Register
	ICC4	—	—	0.6	mA	Vcc1=2.5V, fSCK=5MHz,SO=OPEN Read, Read Status Register
Standby Current	ISB	—	—	1.0	μA	Vcc1=3.6V, CSB=Vcc1, SCK, SI=Vcc1/GND, SO=OPEN

●EEPROM AC operating characteristics (Ta=-30°C to 85°C)

Parameter	Symbol	1.6 ≤ Vcc1 < 1.8V			1.8 ≤ Vcc1 ≤ 3.6V			Unit
		Min.	Typ.	Max.	Min.	Typ.	Max.	
SCK clock Frequency	fSCK	—	—	2.5	—	—	5	MHz
SCK High Time	tSCKWH	200	—	—	80	—	—	ns
SCK Low Time	tSCKWL	200	—	—	80	—	—	ns
CSB High Time	tCS	200	—	—	90	—	—	ns
CSB Setup Time	tCSS	150	—	—	60	—	—	ns
CSB Hold Time	tCSH	150	—	—	60	—	—	ns
SCK Setup Time	tSCKS	50	—	—	50	—	—	ns
SCK Hold Time	tSCKH	50	—	—	50	—	—	ns
SI Setup Time	tDIS	50	—	—	20	—	—	ns
SI Hold Time	tDIH	50	—	—	20	—	—	ns
Output Data Delay Time	tPD	—	—	100	—	—	80	ns
Output Hold Time	tOH	0	—	—	0	—	—	ns
Output Disable Time	tOZ	—	—	200	—	—	80	ns
SCK Rise Time	tRC	—	—	1	—	—	1	μs
SCK Fall Time	tFC	—	—	1	—	—	1	μs
Output Rise Time	tRO	—	—	50	—	—	50	ns
Output Fall Time	tFO	—	—	50	—	—	50	ns
Write Cycle Time	tE/W	—	—	5	—	—	5	ms
Wait Time From Vcc1 ON To EEPROM Command	tON	15	—	—	15	—	—	ms

*1 : Not 100% tested

●Synchronous data input/output timing

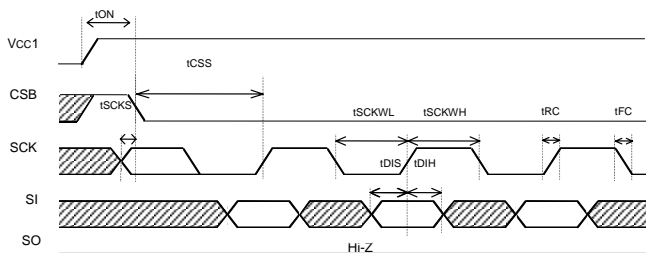

Figure 1. Input timing

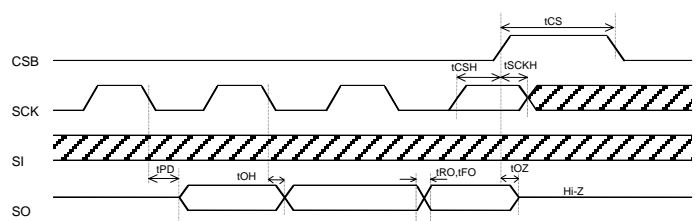

Figure 2. Input and output timing

SI data is latched into the chip at the rising edge of SCK clock. Address and data must be transferred from MSB.

SO data toggles at the falling edge of SCK clock. Output data toggles from MSB.

●AC condition

Parameter	Symbol	Limits			Unit
		Min.	Typ.	Max.	
Load Capacitance	CL	-	-	100	pF
Input Rise times	-	-	-	50	ns
Input Fall times	-	-	-	50	ns
Input Pulse Voltage	-	0.25Vcc1/0.75Vcc1			V
Input and Output Timing Reference Voltages	-	0.3Vcc1/0.7Vcc1			V

●LDO regulator DC operating characteristics (Unless otherwise specified Ta=-30°C to 85°C)

Parameter	Symbol	Specification			Unit	test condition
		Min.	Typ.	Max.		
Output Voltage1-1	VOUT1-1	2.9	3.0	3.2	V	$3.2V \leq V_{cc2} \leq 3.6V$, IOUT=0, 2mA, VSET=1, 0=[1:1]
Output Voltage1-2	VOUT1-2	2.9	3.0	3.1	V	$3.2V \leq V_{cc2} \leq 3.6V$, IOUT=2, 10mA, VSET=1, 0=[1:1]
Output Voltage2-1	VOUT2-1	2.8	2.9	3.1	V	$3.1V \leq V_{cc2} \leq 3.6V$, IOUT=0, 2mA, VSET=1, 0=[1:0]
Output Voltage2-2	VOUT2-2	2.8	2.9	3.0	V	$3.1V \leq V_{cc2} \leq 3.6V$, IOUT=2, 10mA, VSET=1, 0=[1:0]
Output Voltage3-1	VOUT3-1	2.7	2.8	3.0	V	$3.0V \leq V_{cc2} \leq 3.6V$, IOUT=0, 2mA, VSET=1, 0=[0:1]
Output Voltage3-2	VOUT3-2	2.7	2.8	2.9	V	$3.0V \leq V_{cc2} \leq 3.6V$, IOUT=2, 10mA, VSET=1, 0=[0:1]
Output Voltage4-1	VOUT4-1	2.6	2.7	2.9	V	$2.9V \leq V_{cc2} \leq 3.6V$, IOUT=0, 2mA, VSET=1, 0=[0:0]
Output Voltage4-2	VOUT4-2	2.6	2.7	2.8	V	$2.9V \leq V_{cc2} \leq 3.6V$, IOUT=2, 10mA, VSET=1, 0=[0:0]
Operating Current	ICC	-	-	200	μA	Vcc2=3.6V, IOUT=0A
Standby Current	ISB	-	-	1.0	μA	Vcc2=3.6V, IOUT=0A, LDOEN=GND
"H" Input Voltage	VIH	1.4	-	Vcc2+0.3	V	$2.9V \leq V_{cc2} \leq 3.6V$
"L" Input Voltage	VIL	-0.3	-	0.6	V	$2.9V \leq V_{cc2} \leq 3.6V$

●LDO regulator AC operating characteristics

Parameter	Symbol	Specification			Unit	Test condition
		Min.	Typ.	Max.		
Vcc1 Rise Time	tVCC1	-	-	5	msec	Vcc1 x 0%→Vcc1 x 95% point
LDOEN Wait Time	tLDOEN	15	-	-	msec	Vcc1 x 0%point→LDOEN=High

●Output voltage depend on VSET bit

The 2bit data are stored into the VSET memory and output voltage change among VOUT1 to VOUT4. VSET data are written into non-volatile memory array. Initial VSET data is 1, 0 in VSET[1:0] and VOUT is 2.9V.

STEP	VOUT (typ.) [V]	VSET1	VSET0
VOUT1	3.0	1	1
VOUT2	2.9	1	0
VOUT3	2.8	0	1
VOUT4	2.7	0	0

●Input power supply regulation timing

①Using EEPROM PART

In case of using EEPROM part, be sure to raise Vcc1 up to operating voltage. In this time, Vcc2 has no connection with operating.

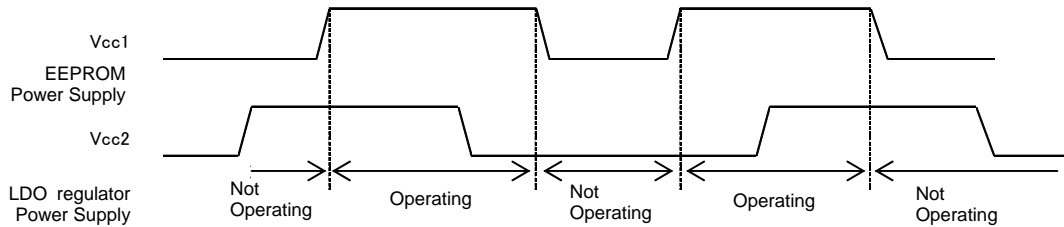

Figure 3. Using EEPROM Part, Regulation Timing

②Using LDO regulator part

In case of using LDO regulator part, be sure to raise Vcc1 and Vcc2 up to operating voltage. After rising Vcc1, wait 15msec and rising LDOEN. When LDOEN is raised, Vcc1 must be operating voltage.

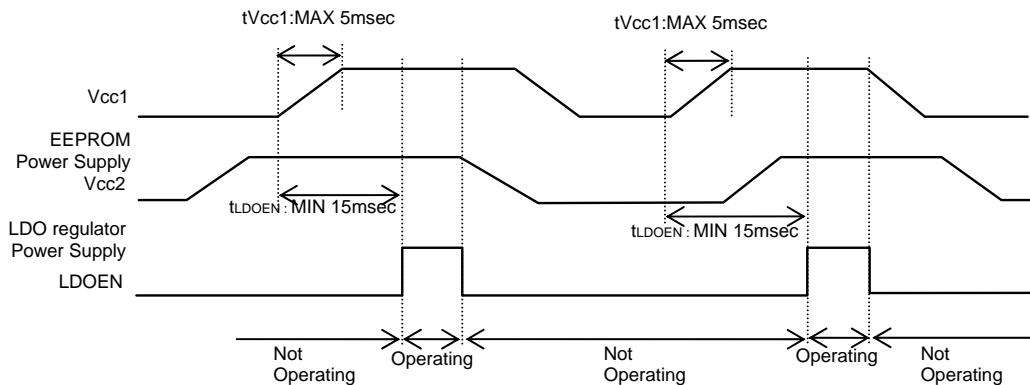

Figure 4. Using LDO Regulator Part, Regulation Timing

● Typical Performance Curves

(The following characteristic data are typical values.)

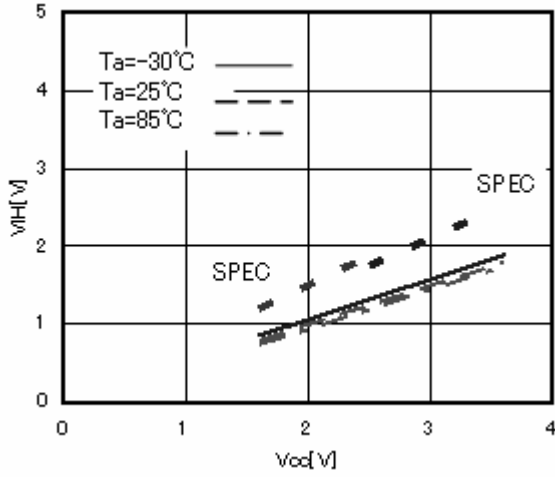

Figure 5. "H" input voltage VIH (EEPROM)

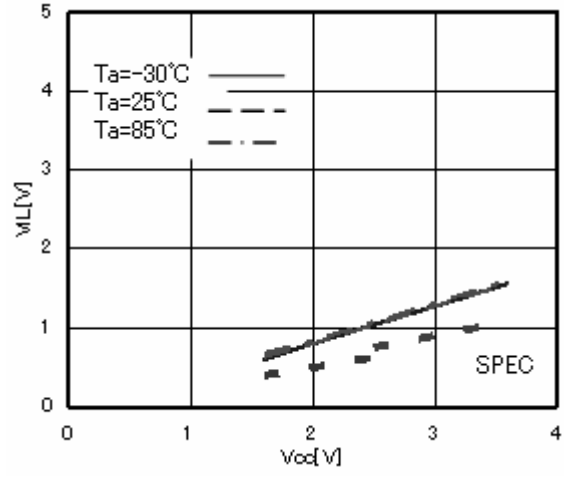

Figure 6. "L" input voltage VIL (EEPROM)

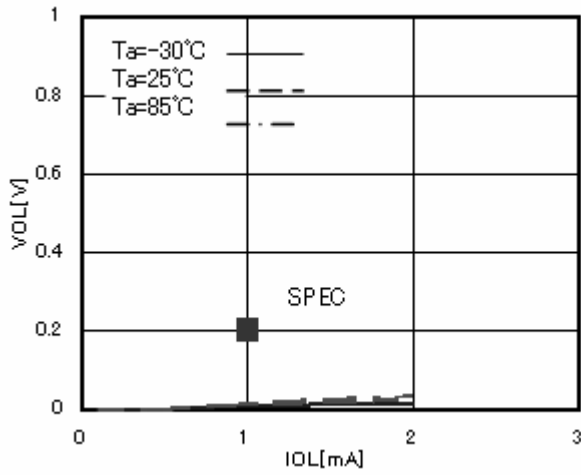

Figure 7. "L" output voltage VOL

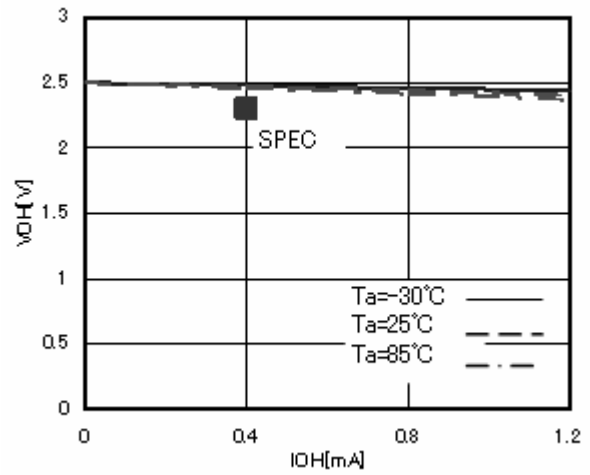

Figure 8. "H" output voltage VOH

● Typical Performance Curves - Continued

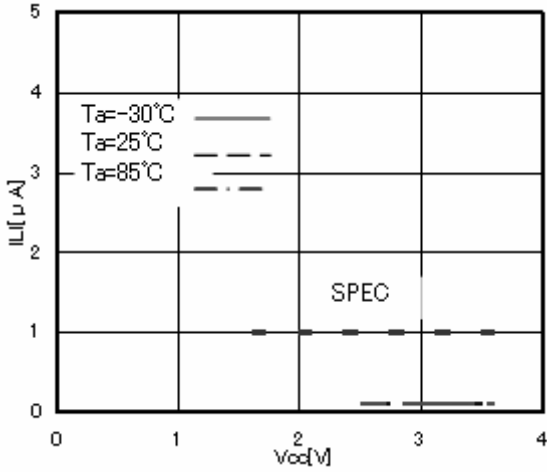

Figure 9. Input leak current ILI

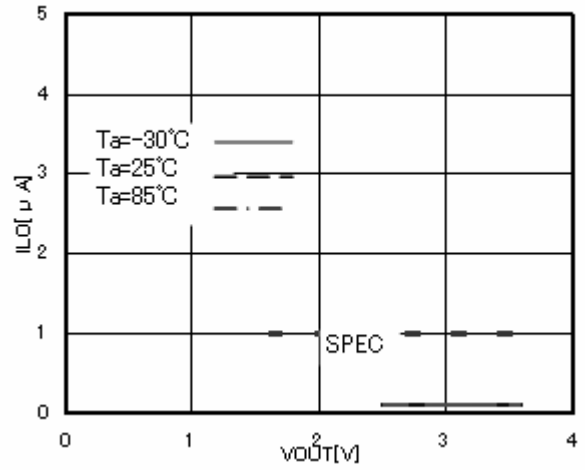

Figure 10. Output leak current ILO

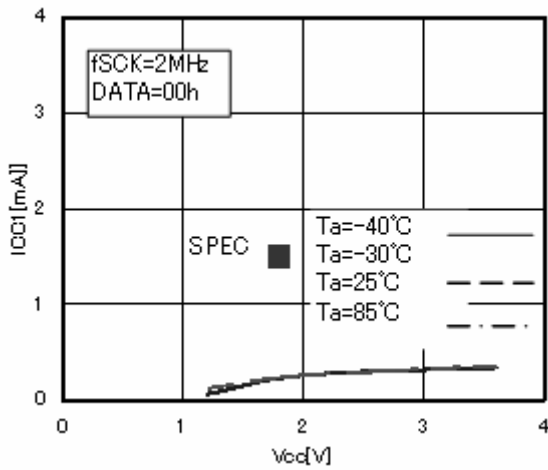

Figure 11. Current consumption at WRITE operation ICC1

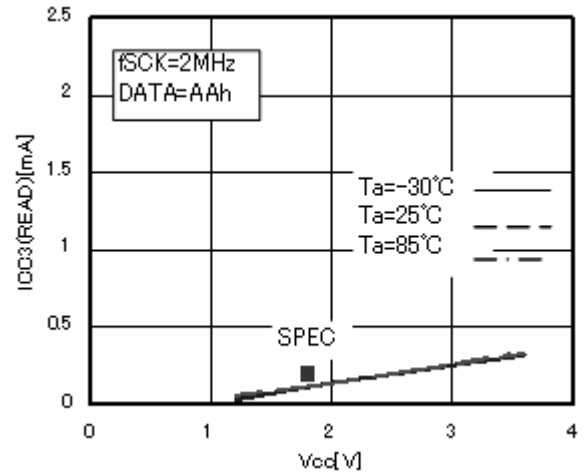

Figure 12. Consumption Current at READ operation ICC3

● Typical Performance Curves - Continued

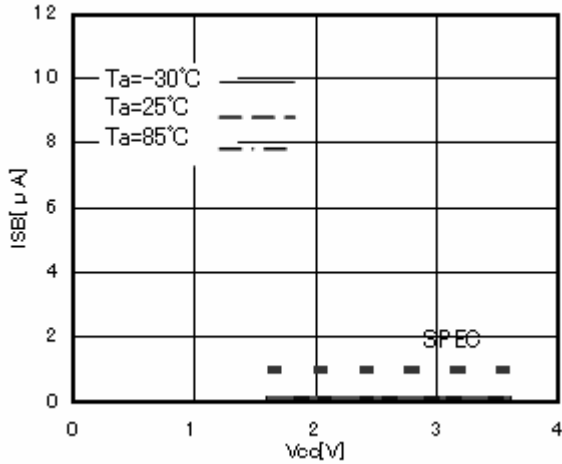

Figure 13. Standby operation ISB (EEPROM)

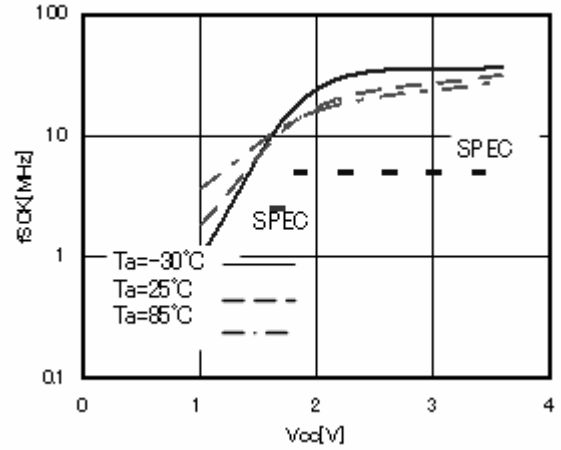

Figure 14. SCK frequency fSCK

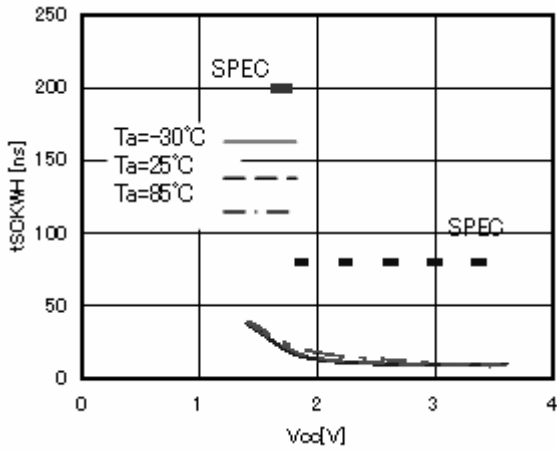

Figure 15. SCK high time tSCKWH

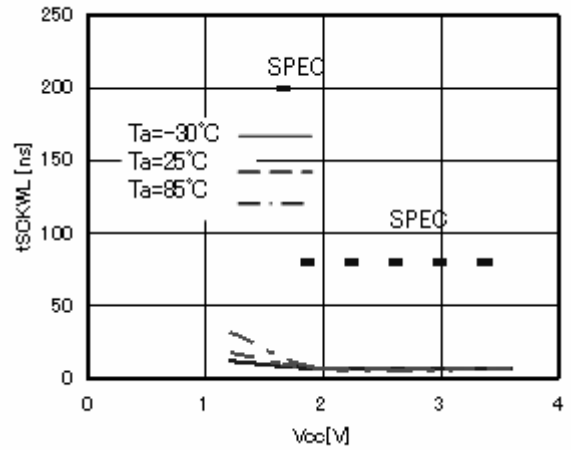

Figure 16. SCK low time tSCKWL

● Typical Performance Curves - Continued

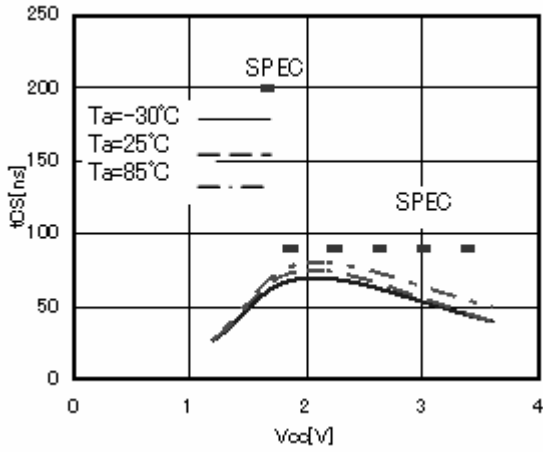

Figure 17. CSB high time tCS

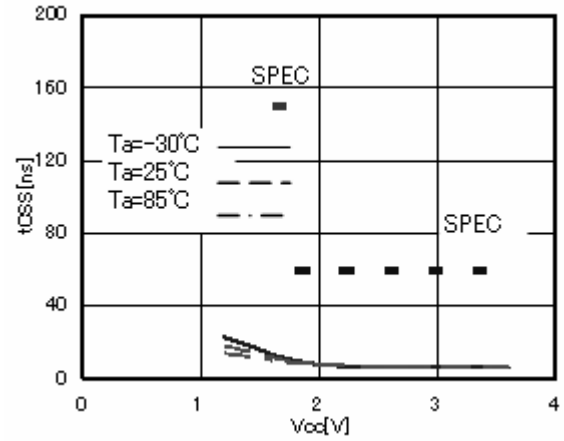

Figure 18. CSB setup time tCSS

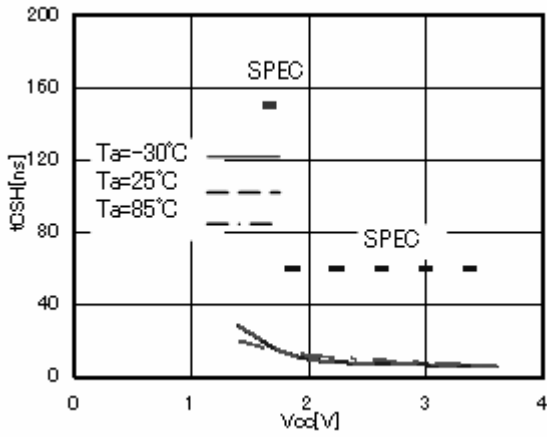

Figure 19. CSB hold time tCSH

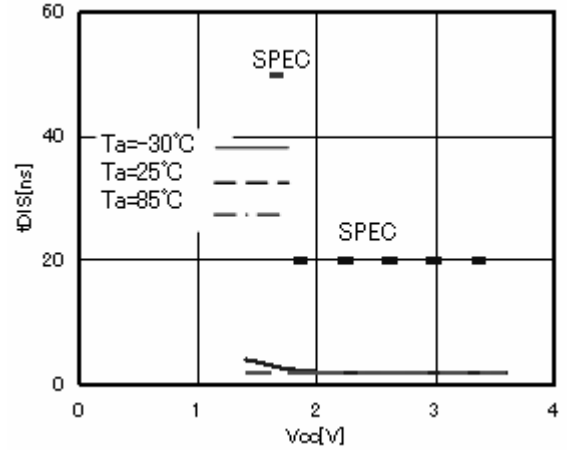

Figure 20. SI setup time tDIS

● Typical Performance Curves - Continued

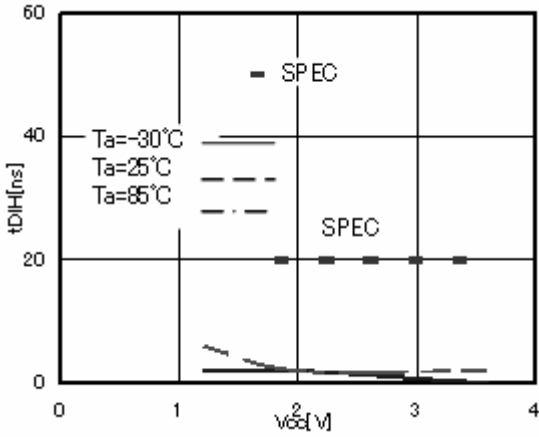

Figure 21. SI hold time tDIH

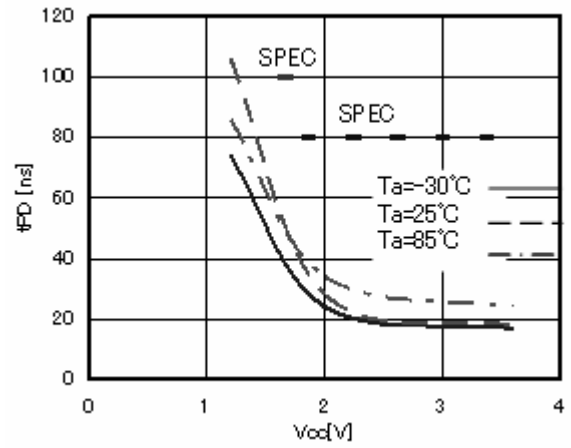

Figure 22. Data output delay time tPD

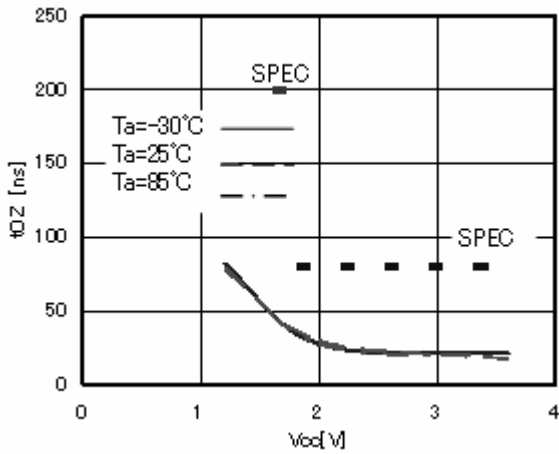

Figure 23. Output disable time tOZ

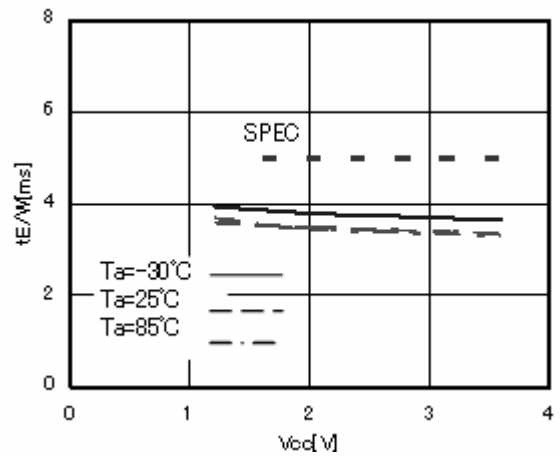

Figure 24. Write cycle time tE/W

● Typical Performance Curves - Continued

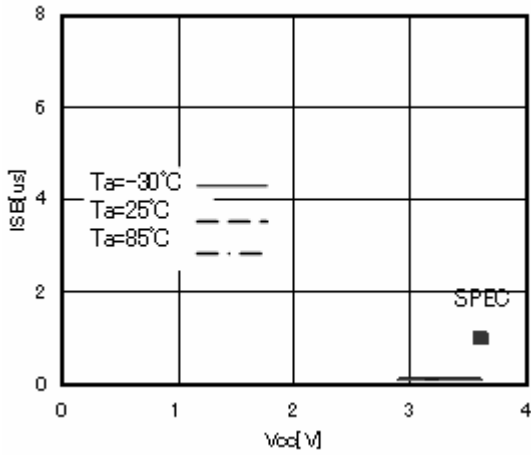

Figure 25. Standby operation ISB (LDO)

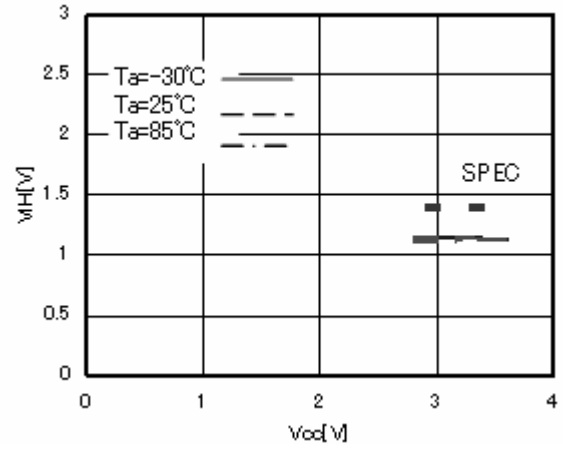

Figure 26. "H" input voltage VIH (LDO)

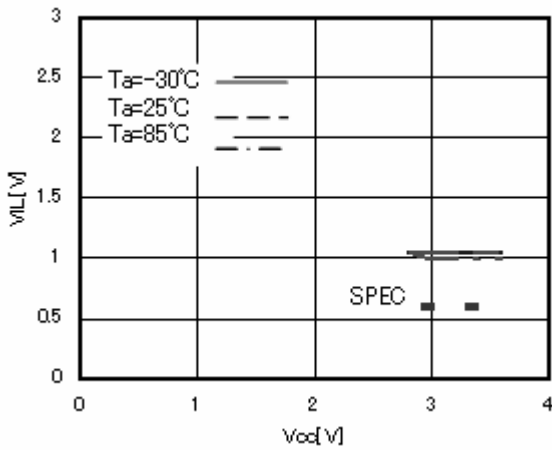

Figure 27. "L" input voltage VIL (LDO)

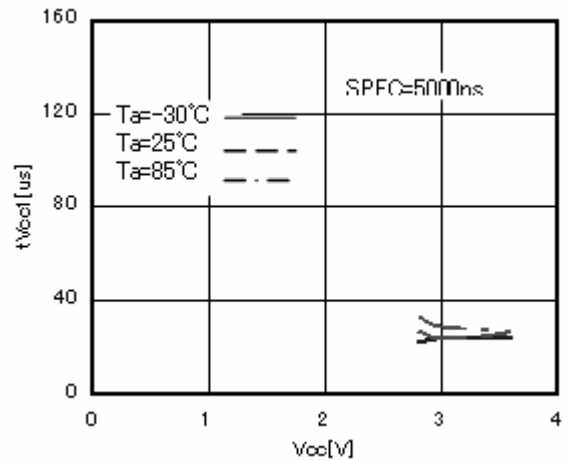

Figure 28. Vcc1 rise time tVcc1

● Typical Performance Curves - Continued

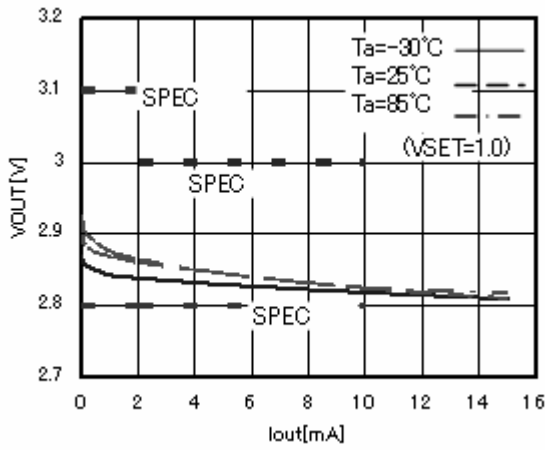

Figure 29. Vout response (LDO)

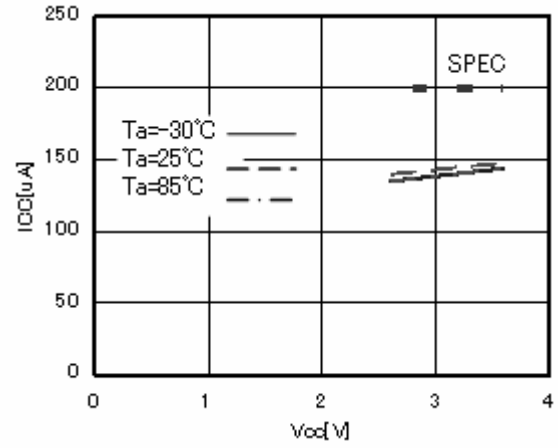

Figure 30. Current consumption ICC (LDO)

●Functional description

○Status Register

The device has status register.

Status register consists of 8bits and is shown following parameters.

2 bits (BP0 and BP1) are set by “Write Status Register” commands, which are non-volatile.

Specification of endurance and data retention are as well as memory array. WEN bit is set by “Write Enable” and “Write Disable” commands. After power become on, the device is disable mode. \bar{R}/B bit is a read-only and status bit. The device is clocked out value of the status register by “Read Status Register” command input.

Bit7	Bit6	Bit5	Bit4	Bit3	Bit2	Bit1	Bit0
0	0	0	0	BP1	BP0	WEN	\bar{R}/B

Bit	Definition
BP0/BP1	Block write protection for memory array (EEPROM)
WEN	Write enable/disable status bit WEN=0 : write disable WEN=1 : write enable
\bar{R}/B	READY/BUSY status bit $\bar{R}/B=0$: READY $\bar{R}/B=1$: BUSY

BP1	BP0	Block Write Protection
0	0	NONE
0	1	600h-7FFh
1	0	400h-7FFh
1	1	000h-7FFh

●Instruction code

Instruction	Operation	Op.Code	Address
WREN	Write enable	0000 0110	-
WRDI	Write disable	0000 0100	-
READ	Read data from memory array	0000 0011	A10 to A0
WRITE	Write data to memory array	0000 0010	A10 to A0
RDSR	Read status register	0000 0101	-
WRSR	Write status register	0000 0001	-
VSET_READ	Read VSET data	0000 0011	800h
VSET_WRITE	Write VSET data	0000 0010	800h

●Timing chart

1. WRITE ENABLE

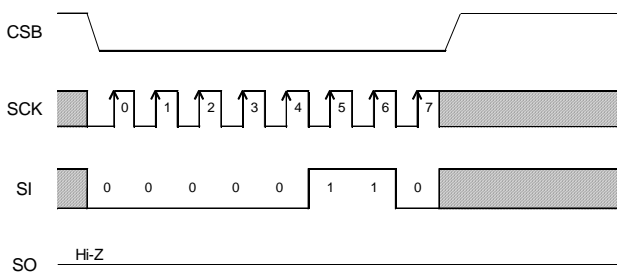

Figure 31. WRITE ENABLE CYCLE TIMING

2. WRITE DISABLE

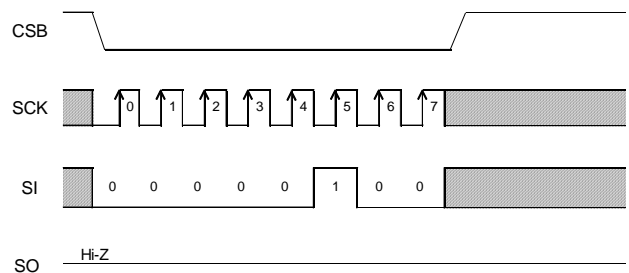

Figure 32. WRITE DISABLE CYCLE TIMING

○The device has both of the enable and disable mode. After “Write Enable” is executed, the device becomes in the enable mode. After “Write Disable” is executed, the device becomes in the disable mode. After CSB goes low, each of Op.code is recognized at the rising edge of 7th clock. Each of instructions is effective inputting seven or more SCK clocks. This “Write Enable” instruction must be proceeded before the any write commands. The device ignores inputting the any write commands in the disable mode. Once the any write commands is executed in the enable mode, the device becomes the disable mode. After the power become on, the device is in the disable mode.

3. READ

The data stored in the memory are clocked out after "Read" instruction is received. After CSB goes low, the address need to be sent following by Op.code of "Read". The data at the address specified are clocked out from D7 to D0, which is start at the falling edge of 23th clock. This device has the auto-increment feature that provides the whole data of the memory array with one read command, outputs the next address data following the addressed 8bits of data by keeping SCK clocking. When the highest address is reached, the address counter rolls over to the lowest address allowing the continuous read cycle.

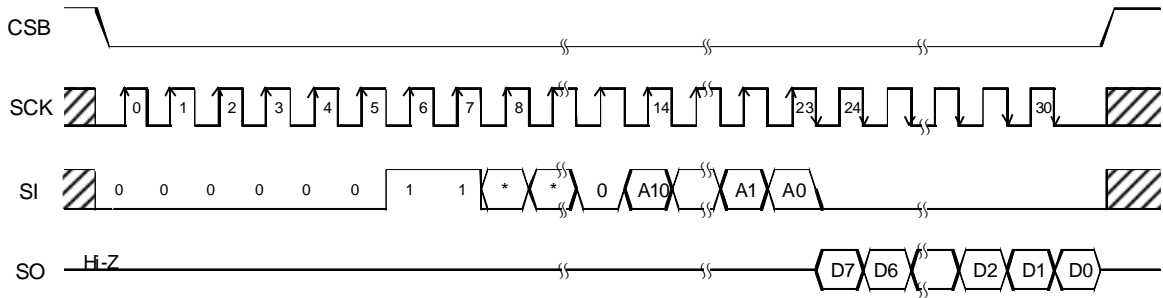

Figure 33. READ CYCLE TIMING

*=Don't care

4. WRITE

This "Write" command writes 8bits of data into the specified address. After CSB goes low, the address need to be sent following by Op.code of "Write". Between the rising edge of the 29th clock and it of the 30th clock, the rising edge of CSB initiates high voltage cycle, which writes the data into non-volatile memory array, but the command is cancelled if CSB is high except that period. It takes maximum 5ms in high voltage cycle (tE/W). The device does not receive any command except for "Read Status Register" command during this high voltage cycle. This device is capable of writing the data of maximum 32byte into memory array at the same time, which keep inputting two or more byte data with CSB "L" after 8bits of data input. For this Page Write commands, the eight higher order bits of address are set, the six low order address bits are internally incremented by 5bits of data input. If more than 16 words, are transmitted the address counter "roll over", and the previous transmitted data is overwritten.

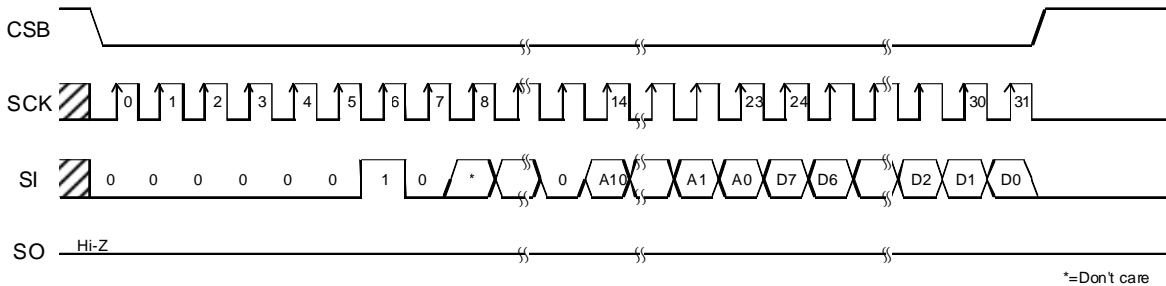

Figure 34. WRITE CYCLE TIMING

*=Don't care

5. RDSR (READ STATUS REGISTER)

The data stored in the status register is clocked out after "Read Status Register" instruction is received. After CSB goes low, Op.colde of "Read Status Register" need to be sent. The data stored in the status register is clocked out of the device on the falling edge of 7th clock. Bit7, Bit6, Bit5 and Bit4 in the status register are read as 0. This device has the auto-increment feature as well as "Read" that output the 8bits of the same data following it to keep SCK clocking. It is possible to see ready and busy state by executing this command during tE/W. If more than 16 words, are transmitted the address counter "roll over" and the previous transmitted data is overwritten.

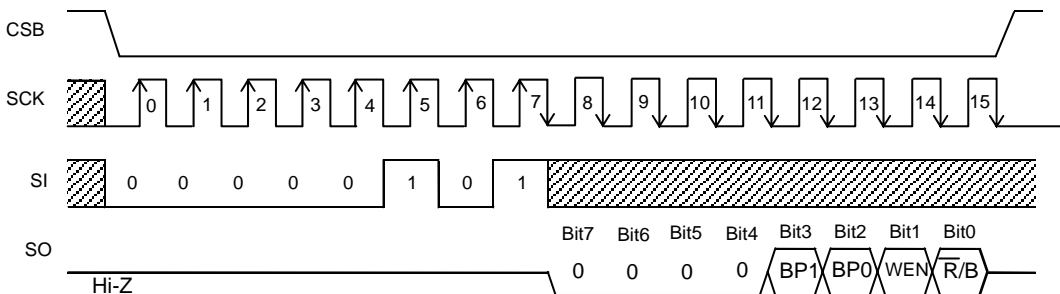

Figure 35. READ STATUS REGISTER CYCLE TIMING

6. WRSR (WRITE STATUS REGISTER)

This "Write Status Register" command writes the data, two (BP1, BP0) of the eight bits, into the status register. Write protection is set by BP1 and BP0 bits. After CSB goes low, Op.code of "Read Status Register" need to sent. Between the rising edge of the 15th clock and it or the 16th clock, the rising edge of CSB initiates high voltage cycle, which writes the data into non-volatile memory array, but the command is cancelled if CSB is high except that period. It takes maximum 5ms in high voltage cycle (tE/W) as well as "Write". Block write protection is determined by BP1 and BP0 bits, which is selected from quarter, half and the entire memory array. (Refer to BLOCK WRITE PROTECTION of Page 13.)

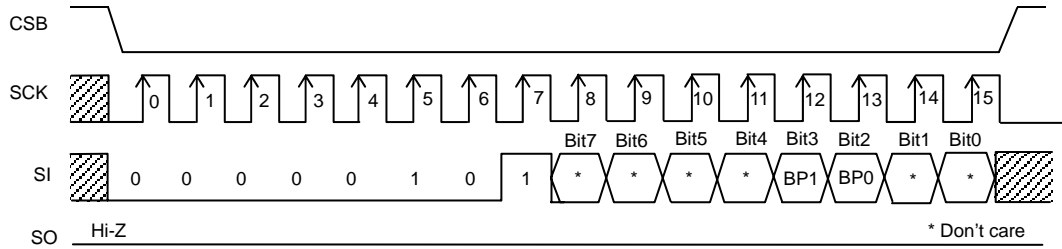

Figure 36. WRITE STATUS REGISTER WRITE CYCLE TIMING

7. VSET READ

The VSET data stored in the memory are clocked out after "VSET Read" instruction set address 800h is received. After CSB goes low, the address (800h) need to be sent following by Op.code of "Read". 0 are clocked out from D7 to D2 and the VSET data are clocked out from D1 to D0, which is start at the falling edge of 23th clock.

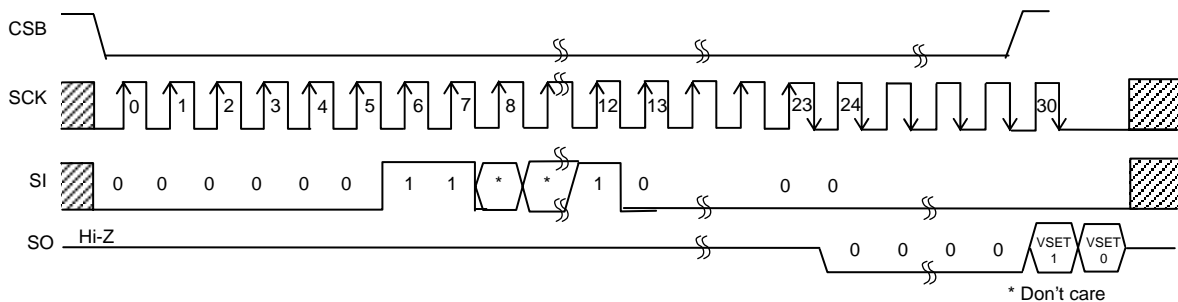

Figure 37. VSET READ CYCLE TIMING

8. VSET WRITE

This "Write" command set address 800h writes VSET data into VSET1 and VSET0 memory array. After CSB goes low, the address (800h) and VSET data need to be sent following by Op.code of "VSET Write". Between the rising edge of the 29th clock and it of the 30th clock, the rising edge of CSB initiates high voltage cycle, which writes the data into non-volatile memory array, but the command is cancelled if CSB is high except that period. It takes maximum 5ms in high voltage cycle (tE/W). The device does not receive any command except for "Read Status Register" command during this high voltage cycle.

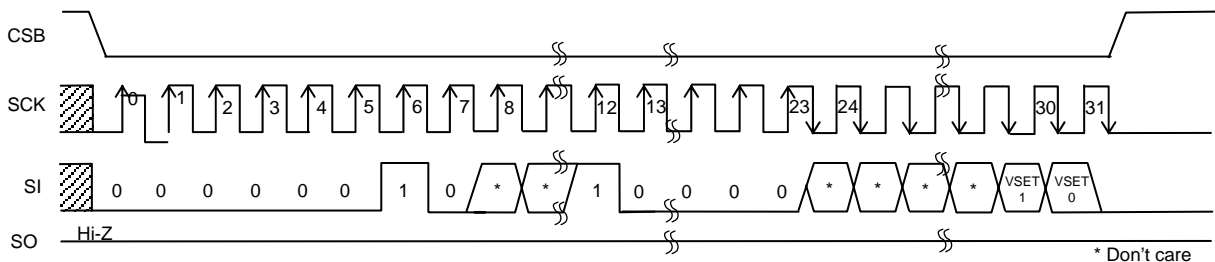

Figure 38. VSET WRITE CYCLE TIMING

●EEPROM soft ware

OREAD, VSET_READ, RDSR Command cancel

Cancel of these commands is possible by changing CSB pin to "HIGH" in all sections.

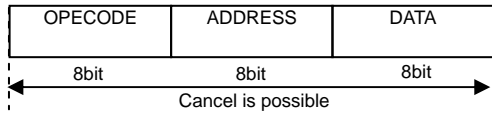

Figure 39. READ, VSET_READ Cancel Timing

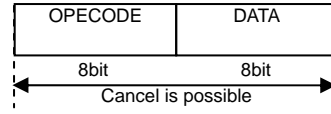

Figure 40. RDSR Cancel Timing

OWRITE, PAGE_WRITE, VSET_WRITE, WRSR Command cancel

Cancel of these write command is possible by changing CSB pin to "HIGH" in opcode, address and data input sections (section a to b), but it is impossible after data input section (section c to d), if Vcc1 is OFF during tE/W, please write again because write data is not guaranteed in specified address, if SCK and CSB rise at the same time in section C, command is instability. It is recommend to rise CSB in "SCK=L" section.

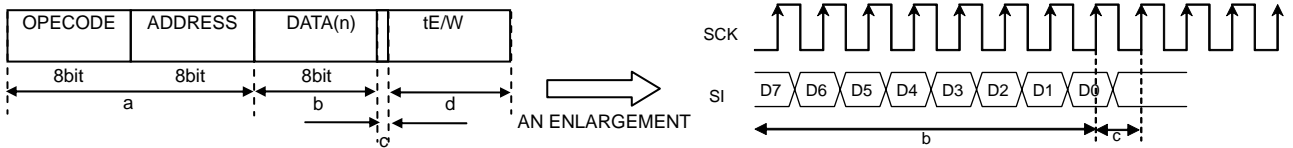

Figure 41. WRITE, PAGE_WRITE, VSET_WRITE READ VSET_READ Cancel Timing

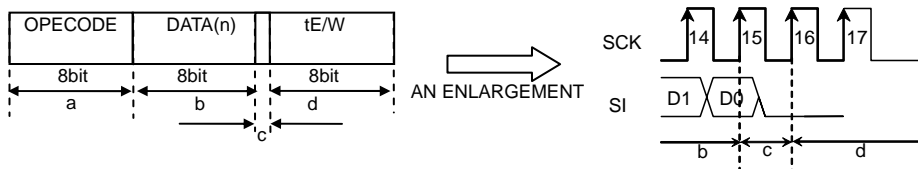

Figure 42. WRSR Cancel Timing

OWREN, WRDI command cancel

Cancel of these commands is possible by changing CSB pin to "HIGH" of opcode to rising 8 clk, but it is impossible after rising 8 clk. In the case, please send WREN or WRDI cancel timing command again.

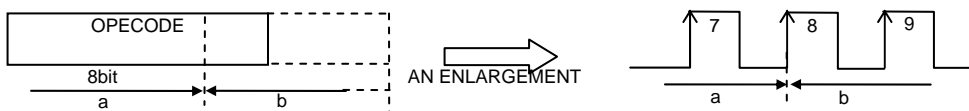

Figure 43. WREN, WRDI Cancel Timing

●Data polling

If RDSR command is carried out during tE/W, according to output data (\bar{R}/B bit), to monitor READY/BUSY state is possible. Because of this, it is possible to send next command earlier than regular programming time (tE/W MAX=5ms). If \bar{R}/B bit is "1", EEPROM's state is "BUSY". If this becomes "0", it is possible to send next command to change EEPROM to "READY" state. Status register data read by this command in tE/W is not data written by WRSR command but old data before. Status register data in each section is shown below.

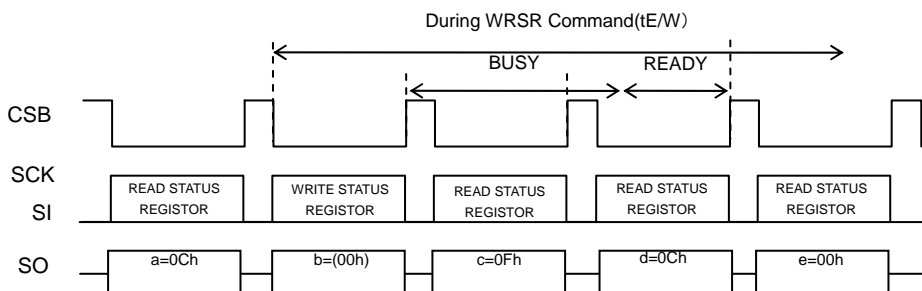

Figure 44. Status register data in each section

●EEPROM part

1. Hardware Connection of EEPROM

EEPROM may have malfunction owing to noise signal for input pin, and movement in the low voltage region at power ON/OFF. These malfunctions may occur, especially at min voltage limit of EEPROM or below. To avoid this, please note about hardware connection showed as follows.

1.1 Input Terminals

Input equivalent circuits of CSB, SCK and SI are showed Figure 45, 46.

Input terminal is connected between CMOS schmitt trigger input circuit and input protection circuit.

These pin are not pull up or pull down, therefore please don't input Hi-Z in use. And please make CSB "HIGH" in the low voltage region at power ON/OFF. If CSB is "LOW" at power ON/OFF, malfunction may occur. To make other input terminals pull up or pull down is recommendable.

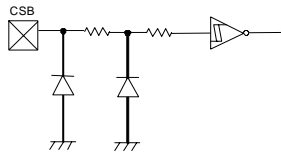

Figure 45. CSB terminals equivalent circuit

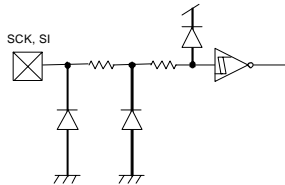

Figure 46. SCK, SI terminals equivalent circuit

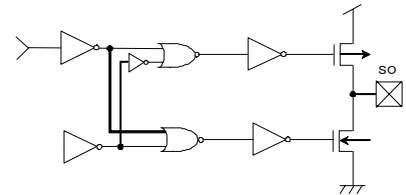

Figure 47. SO terminals equivalent circuit

1.2 Output Terminals

Output equivalent circuit of so is showed Figure 47. This output terminal is 3 states buffer.

The data is output from so at output timing by READ command, so is Hi-z except this timing. If EEPROM malfunction occur by Hi-z input of the microcontroller port connected with so, please make so pull up or pull down. If it doesn't affected the microcontroller movement to make so open, it is no problem. Load capacity of so disturb high speed movement of EEPROM. If this load capacity is 100pF or below, BU9829GUL-W can move in 2.5MHz (Vcc1=1.6V to 1.8V) or 5MHz (Vcc1=1.8V to 3.6V)

1.3 Input pin pull up, pull down resistance

The design method of pull up/pull down resistance for input and output are as follows.

1.3.1 Pull up resistance Rpu of input terminals

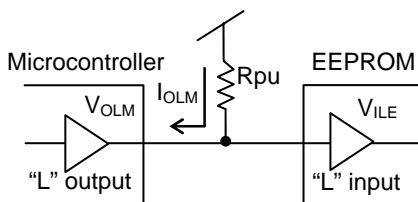

Figure 48. Input terminal pull up resistance

$$R_{pu} \geq \frac{V_{CC} - V_{OLM}}{I_{OLM}} \quad \dots \textcircled{1}$$

$$V_{OLM} \leq V_{ILE} \quad \dots \textcircled{2}$$

Example) When Vcc=5V, VILE=1.5V, VOLM=0.4V, IOLM=2mA, from the equation①,

$$R_{pu} \geq \frac{5 - 0.4}{2 \times 10^{-3}}$$

$$\therefore R_{pu} \geq 2.3[k\Omega]$$

- VILE : EEPROM VIL specifications
- VOLM : Microcontroller VOL specifications
- IOLM : Microcontroller IOL specifications

With the value of Rpu to satisfy the above equation, VOLM becomes 0.4V or below, and with VILE(=1.5V), the equation ② is also satisfied.

1.3.2 Pull down resistance Rpd of input terminals

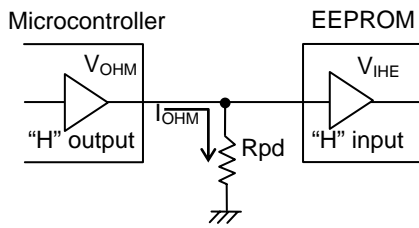

Figure 49. Input terminals Pull down resistance

- V_{IHE} : EEPROM V_{IH} specifications
- V_{OHM} : Microcontroller V_{OH} specifications
- I_{OHM} : Microcontroller I_{OH} specifications

$$R_{pd} \geq \frac{V_{OHM}}{I_{OHM}} \quad \dots\textcircled{1}$$

$$V_{OHM} \leq V_{IHE} \quad \dots\textcircled{2}$$

Example) When V_{CC}=5V, V_{IHE}=3.5V, V_{OHM}=2.4V, I_{OHM}=2mA, from the equation①,

$$R_{pd} \geq \frac{2.4}{2 \times 10^{-3}}$$

$$\therefore R_{pd} \geq 1.2 \text{ [k}\Omega\text{]}$$

With the value of R_{pd} to satisfy the above equation, V_{OHM} becomes 2.4V or higher, and with V_{IHE}(=3.5V), the equation②is also satisfied.

1.3.3 Pull up resistance Rpu of SO pin

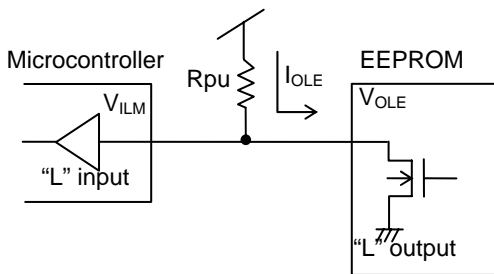

Figure 50. SO Pull up resistance

- V_{OLE} : EEPROM V_{OL} specifications
- I_{OLE} : Microcontroller I_{OL} specifications
- V_{ILM} : Microcontroller V_{IL} specifications

$$R_{pu} \geq \frac{V_{CC}-V_{OLE}}{I_{OLE}} \quad \dots\textcircled{1}$$

$$V_{OLE} \leq V_{ILM} \quad \dots\textcircled{2}$$

Example) When V_{CC}=5V, V_{OLE}=0.4V, V_{ILM}=1.5V, I_{OLE}=2.1mA, from the equation①,

$$R_{pu} \geq \frac{5-0.4}{2.1 \times 10^{-3}}$$

$$\therefore R_{pu} \geq 2.2 \text{ [k}\Omega\text{]}$$

With the value of R_{pu} to satisfy the above equation, V_{OLE} becomes 0.4V or higher, and with V_{ILM}(=1.5V), the equation②is also satisfied.

1.3.4 Pull up resistance Rpu of SO pin

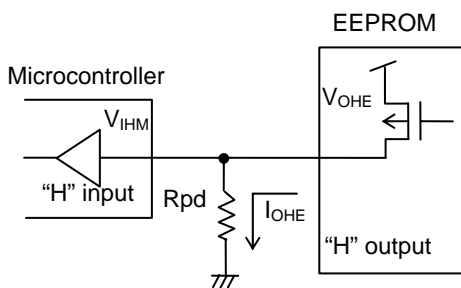

Figure 51. SO Pull down resistance

- V_{OHE} : EEPROM V_{OH} specifications
- I_{OHE} : EEPROM I_{OH} specifications
- V_{IHM} : Microcontroller V_{IH} specifications

$$R_{pd} \geq \frac{V_{OHE}}{I_{OHE}} \quad \dots\textcircled{1}$$

$$V_{OHE} \geq V_{IHM} \quad \dots\textcircled{2}$$

Example) When V_{CC}=5V, V_{OHE}=V_{CC}-0.5V, V_{IHM}=V_{CC}×0.7V, I_{OHE}=0.4mA, from the equation①,

$$R_{pd} \geq \frac{5-0.5}{0.4 \times 10^{-3}}$$

$$\therefore R_{pd} \geq 11.3 \text{ [k}\Omega\text{]}$$

With the value of R_{pu} to satisfy the above equation, V_{OHE} becomes 4.5V or higher, and with V_{IHM}(=3.5V), the equation ② is also satisfied.

●LDO regulator part

LDO regulator part of BU9829GUL-W is CMOSLDO of low power consumption. The data are stored into EEPROM and output voltage change among 2.7 to 3.0V. 1step is 0.1V. LDO regulator part had LDOEN pin and VOUT pin. To make this LDOEN pin LOW is standby mode of low power consumption.

OLDOEN Input Terminals

Input equivalent circuit of LDOEN is showed Figure 52. Input terminal is connected between input circuits made from NMOS and pull up and input protection circuit. This pin is not pull up or pull down, therefore please don't input Hi-z. If LDOEN is LOW, all circuit don't move and LDO part is standby mode of low power consumption.

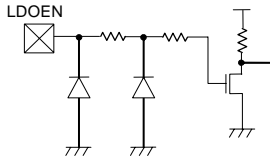

Figure 52. LDOEN output terminals

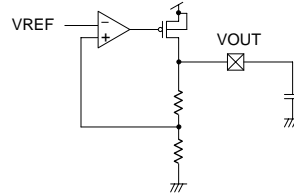
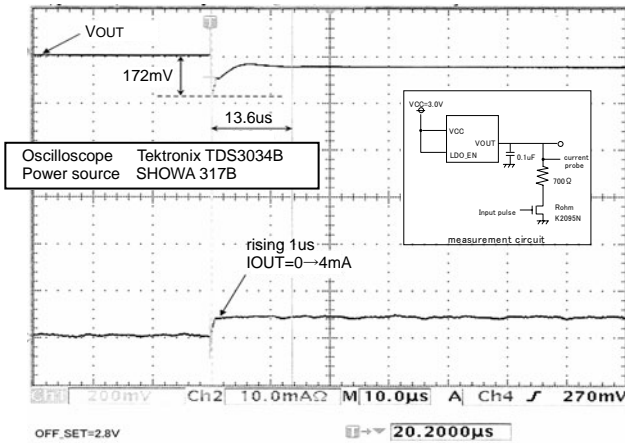

Figure 53. VOUT output terminals

OVOUT Output Terminals

Output equivalent circuit of VOUT is showed Figure 53. If LDOEN is HIGH, LDO regulator output regulate voltage from VOUT pin. If LDOEN is LOW, VOUT pin is GND by VOUT-GND resistance. Output overshoots change by output capacity, in actual use, please evaluate and decide output capacity.



BU9829GUL-W Evaluation result
(IOUT=0mA→4mA, COUT=1.0µF)
Figure 54. CL=0µF Transitional response

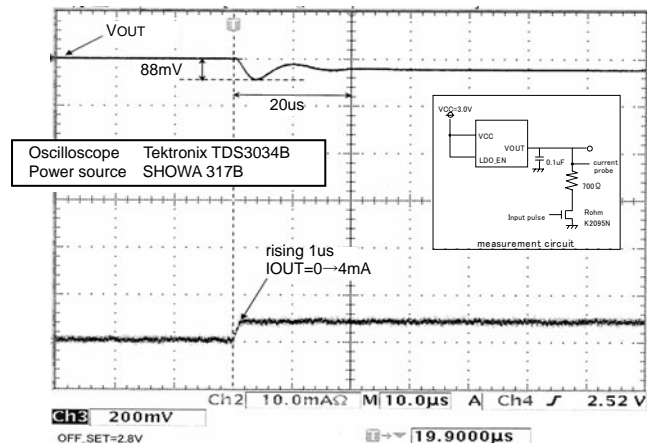

BU9829GUL-W Evaluation result
(IOUT=0mA→4mA, COUT=0.1µF)
Figure 55. CL=0.1µF Transitional response

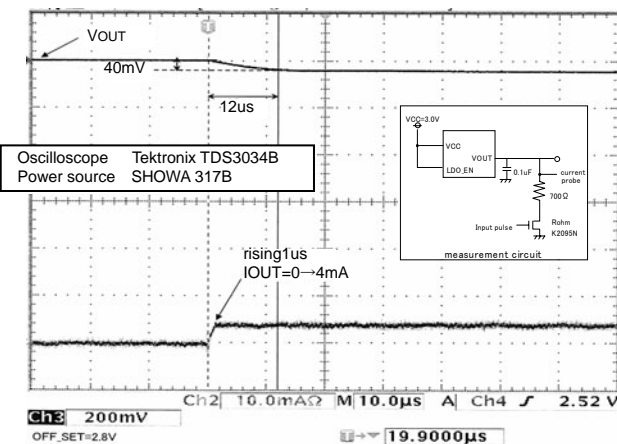

BU9829GUL-W Evaluation result
(IOUT=0mA→4mA, COUT=1.0µF)
Figure 56. CL=1.0µF Transitional response

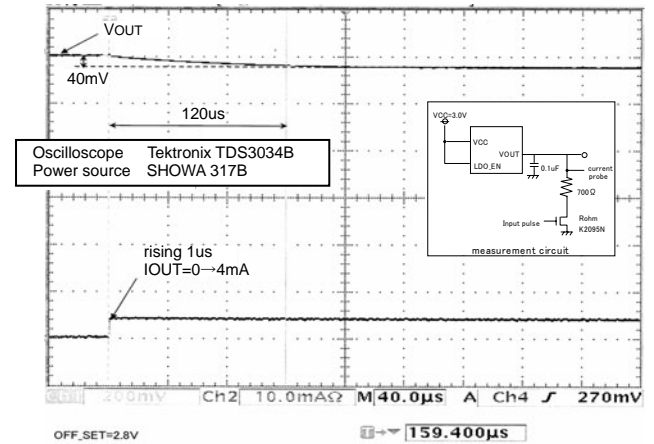

BU9829GUL-W Evaluation result
(IOUT=0mA→4mA, COUT=1.0µF)
Figure 57. CL=10µF Transitional response

○Package power dissipation

Package power dissipation of BU9829GUL-W is 220mW. It is the value at environmental temperature is 25°C. In the case of use at 25°C or higher, degradation is done at 2.2W/°C. If output current is very large, please take care of package power dissipation.

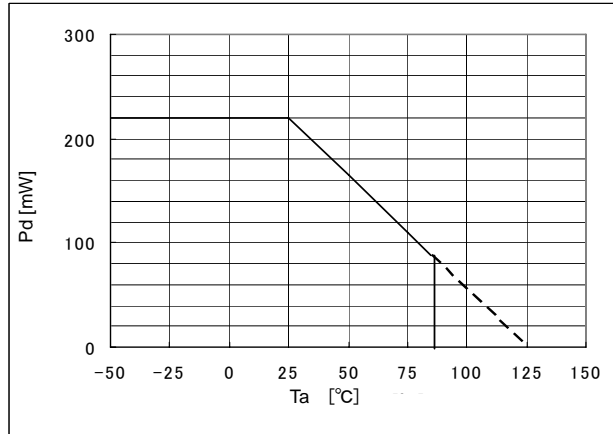

Figure 58. Package power dissipation

○Large Current Protection Circuit

VOUT terminal has large current protection circuit. This circuit protects IC from large current. However, this protection circuit effective unexpected accident. Please avoid continual use of protection circuit.

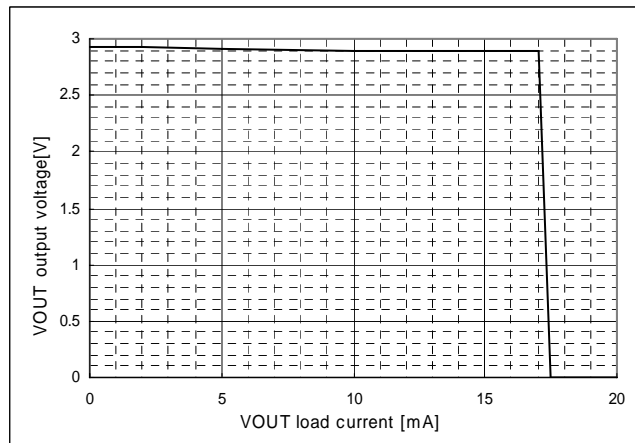

Figure 59. Large Current Protection Circuit

●POR circuit

This IC has a POR (Power On Reset) circuit as mistake write countermeasure. After POR action, it gets in write disable. The POR circuit is valid only when power is ON, and does not work when power is OFF. When power is ON, if the recommended conditions of the following tR, tOFF, and Vbot are not satisfied, it may become write enable status owing to noise the likes.

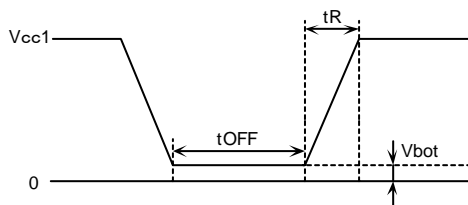

Figure 60. Rise waveform

Recommended conditions of tR, tOFF, Vbot

tR	tOFF	Vbot
10ms or below	10ms or higher	0.3V or below
100ms or below	10ms or higher	0.2V or below

●LVCC circuit

LVCC (Vcc-Lockout) circuit prevents data rewrite action at low power, and prevents wrong write. At LVCC voltage (Typ. =1.9V) or below, it prevents data rewrite.

●Noise countermeasures

○Vcc noise (bypass capacitor)

When noise or surge gets in the power source line, malfunction may occur, therefore, for removing these, it is recommended to attach a bypass capacitor (0.1μF) between IC Vcc and GND. At that moment, attach it as close to IC as possible. And, it is also recommended to attach a bypass capacitor between board Vcc and GND.

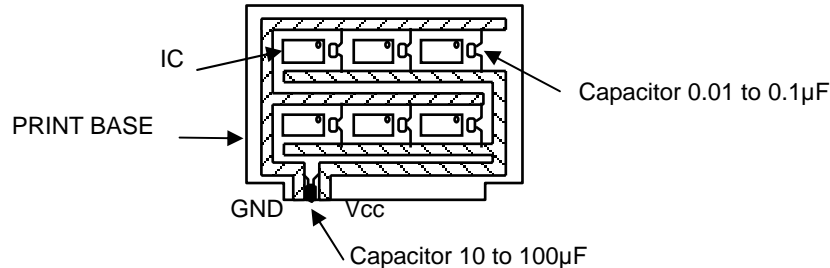

Figure 61. Vcc noise countermeasures example

●Recommendable application circuit

1. It is recommended to attach bypass condensers on power line.
2. Be sure to make CSB pull up. At power on, may cause the abnormal function.
3. Please make LDOEN pull down.
4. If EEPROM malfunction occur by Hi-Z input of the microcontroller part connected with SO, please make SO pull up or pull down.
5. Please attach capacity at V_{OUT} terminal. Outputs overshoot change by output capacity. In actual use, please evaluate and decide output capacity.

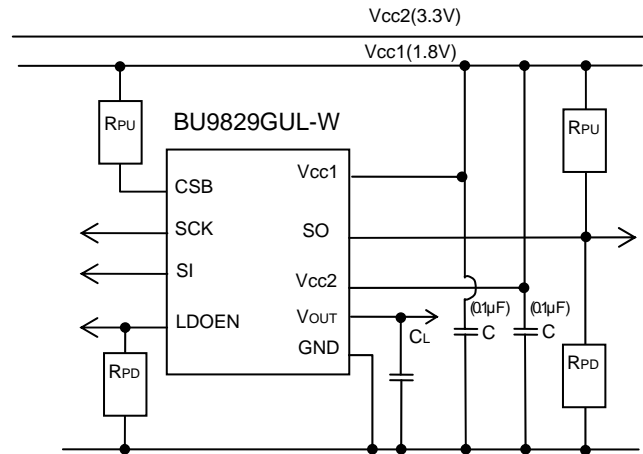

Figure 62. Recommendable Application circuit

●Notes for use

- Absolute maximum ratings
We pay attention to quality control of this IC, but if there is special mode exceeded absolute maximum rating, please take a physical safety measures. Because we can't specify short mode and open mode, etc.
- Heat design
In consideration of permissible dissipation in actual use condition, carry out heat design with sufficient margin.
- Absolute maximum ratings
If the absolute maximum ratings such as impressed voltage and operating temperature range and so forth are exceeded, LSI may be destructed. Do not impress voltage and temperature exceeding the absolute maximum ratings. In the case of fear exceeding the absolute maximum ratings, take physical safety countermeasures such as fuses, and see to it that conditions exceeding the absolute maximum ratings should not be impressed to LSI.
- Common impedance
Please pay attention to Vcc and GND wiring. For example, lower common impedance and to make wiring think, etc.
- GND electric potential
Set the voltage of GND terminal lowest at any action condition. And, please make pin except GND voltage of GND or over.
- Test of set base
If low impedance pin connect with capacity at test of set base, please discharge each test progress to stress IC. Please embroder earth for static electricity measures at structure progress, pay attention to carry and conservation. When set base connect with test base at test progress, please connect and remove from power OFF.

Status of this document

The Japanese version of this document is formal specification. A customer may use this translation version only for a reference to help reading the formal version.

If there are any differences in translation version of this document formal version takes priority.

●Ordering Information

B U 9 8 2 9 G U L - W

E 2

Part Number

Package
GUL: VCSP50L1(BU9829GUL-W)

Packaging and forming specification
E2: Embossed tape and reel

●Physical Dimension Tape and Reel Information

VCSP50L1 (BU9829GUL-W)

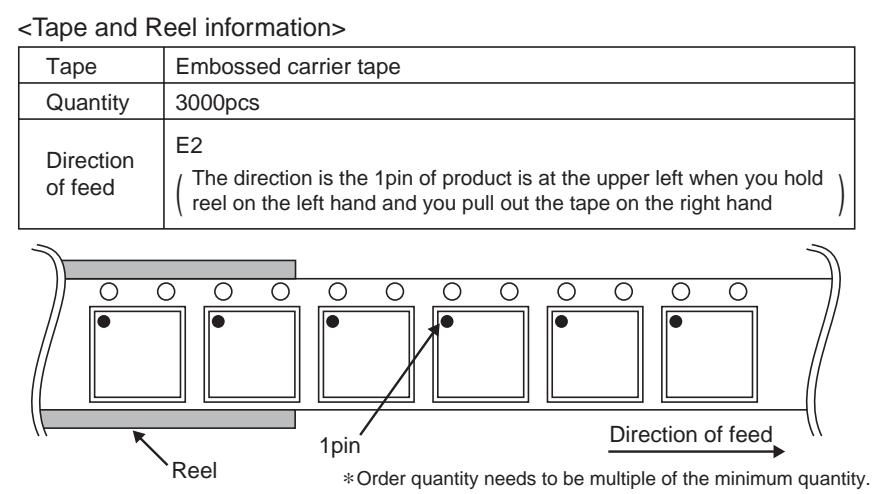
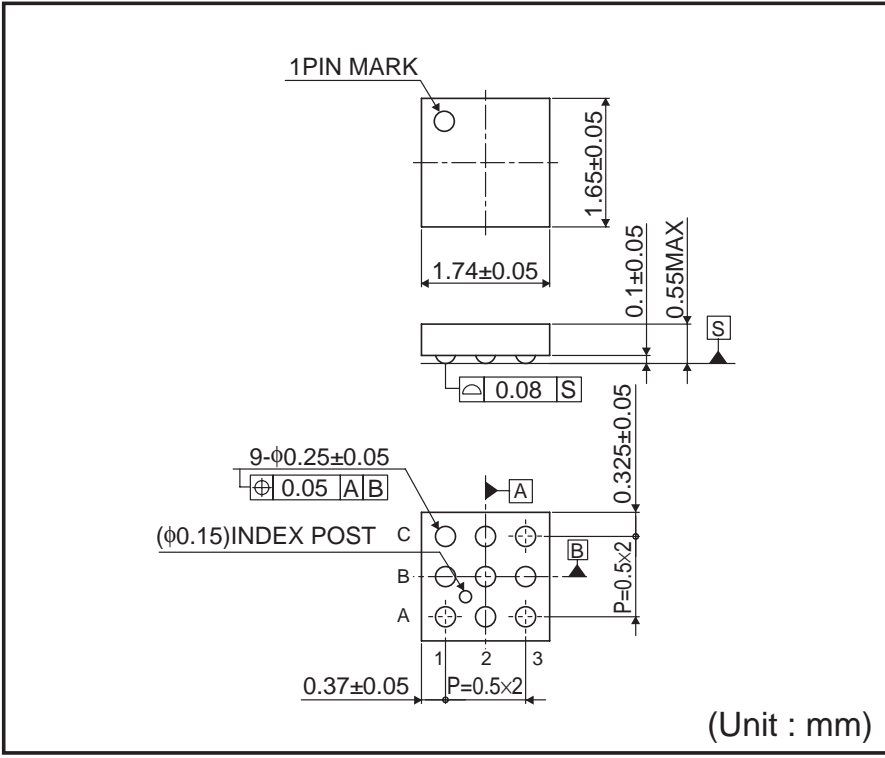

●Marking Diagram

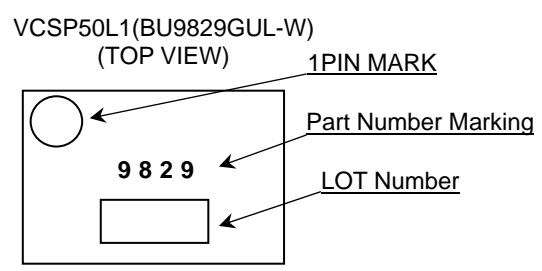

●Revision History

Date	Revision	Changes
28.Aug.2012	001	New Release

Notice

●General Precaution

- 1) Before you use our Products, you are requested to carefully read this document and fully understand its contents. ROHM shall not be in any way responsible or liable for failure, malfunction or accident arising from the use of any ROHM's Products against warning, caution or note contained in this document.
- 2) All information contained in this document is current as of the issuing date and subject to change without any prior notice. Before purchasing or using ROHM's Products, please confirm the latest information with a ROHM sales representative.

●Precaution on using ROHM Products

- 1) Our Products are designed and manufactured for application in ordinary electronic equipments (such as AV equipment, OA equipment, telecommunication equipment, home electronic appliances, amusement equipment, etc.). If you intend to use our Products in devices requiring extremely high reliability (such as medical equipment, transport equipment, traffic equipment, aircraft/spacecraft, nuclear power controllers, fuel controllers, car equipment including car accessories, safety devices, etc.) and whose malfunction or failure may cause loss of human life, bodily injury or serious damage to property ("Specific Applications"), please consult with the ROHM sales representative in advance. Unless otherwise agreed in writing by ROHM in advance, ROHM shall not be in any way responsible or liable for any damages, expenses or losses incurred by you or third parties arising from the use of any ROHM's Products for Specific Applications.
- 2) ROHM designs and manufactures its Products subject to strict quality control system. However, semiconductor products can fail or malfunction at a certain rate. Please be sure to implement, at your own responsibilities, adequate safety measures including but not limited to fail-safe design against the physical injury, damage to any property, which a failure or malfunction of our Products may cause. The following are examples of safety measures:
 - [a] Installation of protection circuits or other protective devices to improve system safety
 - [b] Installation of redundant circuits to reduce the impact of single or multiple circuit failure
- 3) Our Products are designed and manufactured for use under standard conditions and not under any special or extraordinary environments or conditions, as exemplified below. Accordingly, ROHM shall not be in any way responsible or liable for any damages, expenses or losses arising from the use of any ROHM's Products under any special or extraordinary environments or conditions. If you intend to use our Products under any special or extraordinary environments or conditions (as exemplified below), your independent verification and confirmation of product performance, reliability, etc. prior to use, must be necessary:
 - [a] Use of our Products in any types of liquid, including water, oils, chemicals, and organic solvents
 - [b] Use of our Products outdoors or in places where the Products are exposed to direct sunlight or dust
 - [c] Use of our Products in places where the Products are exposed to sea wind or corrosive gases, including Cl₂, H₂S, NH₃, SO₂, and NO₂
 - [d] Use of our Products in places where the Products are exposed to static electricity or electromagnetic waves
 - [e] Use of our Products in proximity to heat-producing components, plastic cords, or other flammable items
 - [f] Sealing or coating our Products with resin or other coating materials
 - [g] Use of our Products without cleaning residue of flux (even if you use no-clean type fluxes, cleaning residue of flux is recommended); or Washing our Products by using water or water-soluble cleaning agents for cleaning residue after soldering
 - [h] Use of the Products in places subject to dew condensation
- 4) The Products are not subject to radiation-proof design.
- 5) Please verify and confirm characteristics of the final or mounted products in using the Products.
- 6) In particular, if a transient load (a large amount of load applied in a short period of time, such as pulse) is applied, confirmation of performance characteristics after on-board mounting is strongly recommended. Avoid applying power exceeding normal rated power; exceeding the power rating under steady-state loading condition may negatively affect product performance and reliability.
- 7) De-rate Power Dissipation (Pd) depending on Ambient temperature (Ta). When used in sealed area, confirm the actual ambient temperature.
- 8) Confirm that operation temperature is within the specified range described in the product specification.
- 9) ROHM shall not be in any way responsible or liable for failure induced under deviant condition from what is defined in this document.

●Precaution for Mounting / Circuit board design

- 1) When a highly active halogenous (chlorine, bromine, etc.) flux is used, the residue of flux may negatively affect product performance and reliability.
- 2) In principle, the reflow soldering method must be used; if flow soldering method is preferred, please consult with the ROHM representative in advance.

For details, please refer to ROHM Mounting specification

●Precautions Regarding Application Examples and External Circuits

- 1) If change is made to the constant of an external circuit, please allow a sufficient margin considering variations of the characteristics of the Products and external components, including transient characteristics, as well as static characteristics.
- 2) You agree that application notes, reference designs, and associated data and information contained in this document are presented only as guidance for Products use. Therefore, in case you use such information, you are solely responsible for it and you must exercise your own independent verification and judgment in the use of such information contained in this document. ROHM shall not be in any way responsible or liable for any damages, expenses or losses incurred by you or third parties arising from the use of such information.

●Precaution for Electrostatic

This Product is electrostatic sensitive product, which may be damaged due to electrostatic discharge. Please take proper caution in your manufacturing process and storage so that voltage exceeding the Products maximum rating will not be applied to Products. Please take special care under dry condition (e.g. Grounding of human body / equipment / solder iron, isolation from charged objects, setting of Ionizer, friction prevention and temperature / humidity control).

●Precaution for Storage / Transportation

- 1) Product performance and soldered connections may deteriorate if the Products are stored in the places where:
 - [a] the Products are exposed to sea winds or corrosive gases, including Cl₂, H₂S, NH₃, SO₂, and NO₂
 - [b] the temperature or humidity exceeds those recommended by ROHM
 - [c] the Products are exposed to direct sunshine or condensation
 - [d] the Products are exposed to high Electrostatic
- 2) Even under ROHM recommended storage condition, solderability of products out of recommended storage time period may be degraded. It is strongly recommended to confirm solderability before using Products of which storage time is exceeding the recommended storage time period.
- 3) Store / transport cartons in the correct direction, which is indicated on a carton with a symbol. Otherwise bent leads may occur due to excessive stress applied when dropping of a carton.
- 4) Use Products within the specified time after opening a humidity barrier bag. Baking is required before using Products of which storage time is exceeding the recommended storage time period.

●Precaution for Product Label

QR code printed on ROHM Products label is for ROHM's internal use only.

●Precaution for Disposition

When disposing Products please dispose them properly using an authorized industry waste company.

●Precaution for Foreign Exchange and Foreign Trade act

Since our Products might fall under controlled goods prescribed by the applicable foreign exchange and foreign trade act, please consult with ROHM representative in case of export.

●Precaution Regarding Intellectual Property Rights

- 1) All information and data including but not limited to application example contained in this document is for reference only. ROHM does not warrant that foregoing information or data will not infringe any intellectual property rights or any other rights of any third party regarding such information or data. ROHM shall not be in any way responsible or liable for infringement of any intellectual property rights or other damages arising from use of such information or data.:
- 2) No license, expressly or implied, is granted hereby under any intellectual property rights or other rights of ROHM or any third parties with respect to the information contained in this document.

●Other Precaution

- 1) The information contained in this document is provided on an "as is" basis and ROHM does not warrant that all information contained in this document is accurate and/or error-free. ROHM shall not be in any way responsible or liable for any damages, expenses or losses incurred by you or third parties resulting from inaccuracy or errors of or concerning such information.
- 2) This document may not be reprinted or reproduced, in whole or in part, without prior written consent of ROHM.
- 3) The Products may not be disassembled, converted, modified, reproduced or otherwise changed without prior written consent of ROHM.
- 4) In no event shall you use in any way whatsoever the Products and the related technical information contained in the Products or this document for any military purposes, including but not limited to, the development of mass-destruction weapons.
- 5) The proper names of companies or products described in this document are trademarks or registered trademarks of ROHM, its affiliated companies or third parties.