Low-power, precision, rail-to-rail, 9.0 MHz, 16 V operational amplifier

Datasheet - production data

**Description**

The TSX7191, TSX7191A single, operational amplifier (op amp) offers high precision functioning with low input offset voltage down to a maximum of 200 μV at 25 °C. In addition, its rail-to-rail input and output functionality allows this product to be used on full range input and output without limitation. This is particularly useful for a low-voltage supply such as 2.7 V that the TSX7191, TSX7191A is able to operate with.

Thus, the TSX7191, TSX7191A has the great advantage of offering a large span of supply voltages, ranging from 2.7 V to 16 V. It can be used in multiple applications with a unique reference.

Low input bias current performance makes the TSX7191, TSX7191A perfect when used for signal conditioning in sensor interface applications. In addition, low-side and high-side current measurements can be easily made thanks to rail-to-rail functionality. The TSX7191, TSX7191A is a decompensated amplifier and must be used with a gain greater than 10 to ensure stability.

High ESD tolerance (4 kV HBM) and a wide temperature range are also good arguments to use the TSX7191, TSX7191A in the automotive market segment.

Features

- Low input offset voltage: 200 μV max.
- Rail-to-rail input and output
- Low current consumption: 850 μA max.
- Gain bandwidth product: 9 MHz
- Low supply voltage: 2.7 - 16 V
- Stable when used with Gain \geq 10
- Low input bias current: 50 pA max.
- High ESD tolerance: 4 kV HBM
- Extended temp. range: -40 °C to +125 °C
- Automotive qualification

Related products

- See the TSX711 for lower speeds with similar precision
- See the TSX561 for low-power features
- See the TSX631 for micro-power features
- See the TSX921 for higher speeds

Applications

- Battery-powered instrumentation
- Instrumentation amplifier
- Active filtering
- High-impedance sensor interface
- Current sensing (high and low side)

Contents

1	Package pin connections.....	3
2	Absolute maximum ratings and operating conditions	4
3	Electrical characteristics	5
4	Application information	16
	4.1 Operating voltages	16
	4.2 Input pin voltage ranges	16
	4.3 Rail-to-rail input	16
	4.4 Rail-to-rail output.....	16
	4.5 Input offset voltage drift over temperature	17
	4.6 Long term input offset voltage drift	17
	4.7 High values of input differential voltage.....	18
	4.8 Capacitive load.....	19
	4.9 PCB layout recommendations.....	20
	4.10 Optimized application recommendation	20
5	Package information	21
	5.1 SOT23-5 package information	22
6	Ordering information.....	23
7	Revision history	24

1 Package pin connections

Figure 1: Pin connections (top view)



2 Absolute maximum ratings and operating conditions

Table 1: Absolute maximum ratings (AMR)

Symbol	Parameter	Value	Unit
V _{CC}	Supply voltage ⁽¹⁾	18	V
V _{id}	Differential input voltage ⁽²⁾	±V _{CC}	mV
V _{in}	Input voltage	V _{CC-} - 0.2 to V _{CC+} + 0.2	V
I _{in}	Input current ⁽³⁾	10	mA
T _{stg}	Storage temperature	-65 to +150	°C
R _{thja}	Thermal resistance junction to ambient ^{(4) (5)}	250	°C/W
T _j	Maximum junction temperature	150	°C
ESD	HBM: human body model ⁽⁶⁾	4000	V
	MM: machine model ⁽⁷⁾	100	
	CDM: charged device model ⁽⁸⁾	1500	
	Latch-up immunity	200	mA

Notes:

- ⁽¹⁾All voltage values, except the differential voltage are with respect to the network ground terminal.
- ⁽²⁾Differential voltages are the non-inverting input terminal with respect to the inverting input terminal. See [Section 4.7](#) for the precautions to follow when using the TSX711 with a high differential input voltage.
- ⁽³⁾Input current must be limited by a resistor in series with the inputs.
- ⁽⁴⁾R_{th} are typical values.
- ⁽⁵⁾Short-circuits can cause excessive heating and destructive dissipation.
- ⁽⁶⁾According to JEDEC standard JESD22-A114F.
- ⁽⁷⁾According to JEDEC standard JESD22-A115A.
- ⁽⁸⁾According to ANSI/ESD STM5.3.1

Table 2: Operating conditions

Symbol	Parameter	Value	Unit
V _{CC}	Supply voltage	2.7 to 16	V
V _{icm}	Common mode input voltage range	V _{CC-} - 0.1 to V _{CC+} + 0.1	
T _{oper}	Operating free air temperature range	-40 to +125	°C

3 Electrical characteristics

Table 3: Electrical characteristics at $V_{CC+} = +4\text{ V}$ with $V_{CC-} = 0\text{ V}$, $V_{icm} = V_{CC}/2$, $T_{amb} = 25\text{ °C}$, and $R_L > 10\text{ k}\Omega$ connected to $V_{CC}/2$ (unless otherwise specified)

Symbol	Parameter	Conditions	Min.	Typ.	Max.	Unit
V_{io}	Input offset voltage	TSX7191, $V_{icm} = V_{CC}/2$			200	μV
		$T_{min} < T_{op} < +85\text{ °C}$			365	
		$T_{min} < T_{op} < +125\text{ °C}$			450	
		TSX7191A, $V_{icm} = V_{CC}/2$			100	
		$T_{min} < T_{op} < +85\text{ °C}$			265	
		$T_{min} < T_{op} < +125\text{ °C}$			350	
$\Delta V_{io}/\Delta T$	Input offset voltage drift ⁽¹⁾				2.5	$\mu\text{V}/\text{°C}$
ΔV_{io}	Long term input offset voltage drift ⁽²⁾	$T = 25\text{ °C}$		1		$\frac{\text{nV}}{\sqrt{\text{month}}}$
I_{ib}	Input bias current ⁽¹⁾	$V_{out} = V_{CC}/2$		1	50	pA
		$T_{min} < T_{op} < T_{max}$			200	
I_{io}	Input offset current ⁽¹⁾	$V_{out} = V_{CC}/2$		1	50	pA
		$T_{min} < T_{op} < T_{max}$			200	
R_{IN}	Input resistance			1		$\text{T}\Omega$
C_{IN}	Input capacitance			12.5		pF
CMRR	Common mode rejection ratio $20 \log (\Delta V_{ic}/\Delta V_{io})$	$V_{icm} = -0.1\text{ to }4.1\text{ V}$, $V_{out} = V_{CC}/2$	84	102		dB
		$T_{min} < T_{op} < T_{max}$	83			
		$V_{icm} = -0.1\text{ to }2\text{ V}$, $V_{out} = V_{CC}/2$	100	122		
		$T_{min} < T_{op} < T_{max}$	94			
A_{vd}	Large signal voltage gain	$R_L = 2\text{ k}\Omega$, $V_{out} = 0.3\text{ to }3.7\text{ V}$	110	136		dB
		$T_{min} < T_{op} < T_{max}$	96			
		$R_L = 10\text{ k}\Omega$, $V_{out} = 0.2\text{ to }3.8\text{ V}$	110	140		
		$T_{min} < T_{op} < T_{max}$	96			
V_{OH}	High level output voltage (voltage drop from V_{CC+})	$R_L = 2\text{ k}\Omega$ to $V_{CC}/2$		28	50	mV
		$T_{min} < T_{op} < T_{max}$			60	
		$R_L = 10\text{ k}\Omega$ to $V_{CC}/2$		6	15	
		$T_{min} < T_{op} < T_{max}$			20	
V_{OL}	Low level output voltage	$R_L = 2\text{ k}\Omega$ to $V_{CC}/2$		23	50	mV
		$T_{min} < T_{op} < T_{max}$			60	
		$R_L = 10\text{ k}\Omega$ to $V_{CC}/2$		5	15	
		$T_{min} < T_{op} < T_{max}$			20	

Electrical characteristics

TSX7191, TSX7191A

Symbol	Parameter	Conditions	Min.	Typ.	Max.	Unit
I _{out}	I _{sink}	V _{out} = V _{CC}	35	45		mA
		T _{min} < T _{op} < T _{max}	20			
	I _{source}	V _{out} = 0 V	35	45		
		T _{min} < T _{op} < T _{max}	20			
I _{CC}	Supply current per amplifier	No load, V _{out} = V _{CC} /2		570	800	μA
		T _{min} < T _{op} < T _{max}			900	
GBP	Gain bandwidth product	R _L = 10 kΩ, C _L = 100 pF	5	7.7		MHz
φ _m	Phase margin	Gain = 10, R _L = 10 kΩ, C _L = 100 pF		42		Degrees
SR _n	Negative slew rate	A _v = 10, V _{out} = 3 V _{PP} , 10 % to 90 %	1.3	2.3		V/μs
		T _{min} < T _{op} < T _{max}	1.0			
SR _p	Positive slew rate	A _v = 10, V _{out} = 3 V _{PP} , 10 % to 90 %	1.5	2.5		
		T _{min} < T _{op} < T _{max}	1.1			
e _n	Equivalent input noise voltage	f = 1 kHz		22		$\frac{nV}{\sqrt{Hz}}$
		f = 10 kHz		19		
THD+N	Total harmonic distortion + noise	f = 1 kHz, A _v = 10, R _L = 10 kΩ, BW = 22 kHz, V _{out} = 3V _{PP}		0.003		%

Notes:

⁽¹⁾Maximum values are guaranteed by design.

⁽²⁾Typical value is based on the V_{io} drift observed after 1000h at 125 °C extrapolated to 25 °C using the Arrhenius law and assuming an activation energy of 0.7 eV. The operational amplifier is aged in follower mode configuration (see [Section 4.6](#)).

Table 4: Electrical characteristics at $V_{CC+} = +10\text{ V}$ with $V_{CC-} = 0\text{ V}$, $V_{icm} = V_{CC}/2$, $T_{amb} = 25\text{ °C}$, and $R_L > 10\text{ k}\Omega$ connected to $V_{CC}/2$ (unless otherwise specified)

Symbol	Parameter	Conditions	Min.	Typ.	Max.	Unit
V_{io}	Input offset voltage	TSX7191, $V_{icm} = V_{CC}/2$			200	μV
		$T_{min} < T_{op} < +85\text{ °C}$			365	
		$T_{min} < T_{op} < +125\text{ °C}$			450	
		TSX7191A, $V_{icm} = V_{CC}/2$			100	
		$T_{min} < T_{op} < +85\text{ °C}$			265	
		$T_{min} < T_{op} < +125\text{ °C}$			350	
$\Delta V_{io}/\Delta T$	Input offset voltage drift ⁽¹⁾				2.5	$\mu\text{V}/\text{°C}$
ΔV_{io}	Long term input offset voltage drift ⁽²⁾	$T = 25\text{ °C}$		25		$\frac{\text{nV}}{\sqrt{\text{month}}}$
I_{ib}	Input bias current ⁽¹⁾	$V_{out} = V_{CC}/2$		1	50	pA
		$T_{min} < T_{op} < T_{max}$			200	
I_{io}	Input offset current ⁽¹⁾	$V_{out} = V_{CC}/2$		1	50	pA
		$T_{min} < T_{op} < T_{max}$			200	
R_{IN}	Input resistance			1		$\text{T}\Omega$
C_{IN}	Input capacitance			12.5		pF
CMRR	Common mode rejection ratio 20 log ($\Delta V_{ic}/\Delta V_{io}$)	$V_{icm} = -0.1\text{ to }10.1\text{ V}$, $V_{out} = V_{CC}/2$	90	102		dB
		$T_{min} < T_{op} < T_{max}$	86			
		$V_{icm} = -0.1\text{ to }8\text{ V}$, $V_{out} = V_{CC}/2$	105	117		
		$T_{min} < T_{op} < T_{max}$	95			
A_{vd}	Large signal voltage gain	$R_L = 2\text{ k}\Omega$, $V_{out} = 0.3\text{ to }9.7\text{ V}$	110	140		dB
		$T_{min} < T_{op} < T_{max}$	100			
		$R_L = 10\text{ k}\Omega$, $V_{out} = 0.2\text{ to }9.8\text{ V}$	110			
		$T_{min} < T_{op} < T_{max}$	100			
V_{OH}	High level output voltage (voltage drop from V_{CC+})	$R_L = 2\text{ k}\Omega$ to $V_{CC}/2$		45	70	mV
		$T_{min} < T_{op} < T_{max}$			80	
		$R_L = 10\text{ k}\Omega$ to $V_{CC}/2$		10	30	
		$T_{min} < T_{op} < T_{max}$			40	
V_{OL}	Low level output voltage	$R_L = 2\text{ k}\Omega$ to $V_{CC}/2$		42	70	mV
		$T_{min} < T_{op} < T_{max}$			80	
		$R_L = 10\text{ k}\Omega$ to $V_{CC}/2$		9	30	
		$T_{min} < T_{op} < T_{max}$			40	
I_{out}	I_{sink}	$V_{out} = V_{CC}$	50	70		mA
		$T_{min} < T_{op} < T_{max}$	40			
	I_{source}	$V_{out} = 0\text{ V}$	50	69		
		$T_{min} < T_{op} < T_{max}$	40			

Electrical characteristics

TSX7191, TSX7191A

Symbol	Parameter	Conditions	Min.	Typ.	Max.	Unit
I _{CC}	Supply current per amplifier	No load, V _{out} = V _{CC} /2		630	850	μA
		T _{min} < T _{op} < T _{max}			1000	
GBP	Gain bandwidth product	R _L = 10 kΩ, C _L = 100 pF	5	9		MHz
φ _m	Phase margin	G = 10, R _L = 10 kΩ, C _L = 100 pF		48		Degrees
SR _n	Negative slew rate	A _v = 10, V _{out} = 8 V _{PP} , 10 % to 90 %	1.3	2.3		V/μs
		T _{min} < T _{op} < T _{max}	1.0			
SR _p	Positive slew rate	A _v = 10, V _{out} = 8 V _{PP} , 10 % to 90 %	1.5	2.5		
		T _{min} < T _{op} < T _{max}	1.1			
e _n	Equivalent input noise voltage	f = 1 kHz		22		$\frac{nV}{\sqrt{Hz}}$
		f = 10 kHz		19		
THD+N	Total harmonic distortion + noise	f = 1 kHz, A _v = 10, R _L = 10 kΩ, BW = 22 kHz, V _{out} = 9 V _{PP}		0.0001		%

Notes:

⁽¹⁾Maximum values are guaranteed by design.

⁽²⁾Typical value is based on the V_{io} drift observed after 1000h at 125 °C extrapolated to 25 °C using the Arrhenius law and assuming an activation energy of 0.7 eV. The operational amplifier is aged in follower mode configuration (see [Section 4.6](#)).

Table 5: Electrical characteristics at $V_{CC+} = +16\text{ V}$ with $V_{CC-} = 0\text{ V}$, $V_{icm} = V_{CC}/2$, $T_{amb} = 25\text{ °C}$, and $R_L > 10\text{ k}\Omega$ connected to $V_{CC}/2$ (unless otherwise specified)

Symbol	Parameter	Conditions	Min.	Typ.	Max.	Unit
V_{io}	Input offset voltage	TSX7191, $V_{icm} = V_{CC}/2$			200	μV
		$T_{min} < T_{op} < +85\text{ °C}$			365	
		$T_{min} < T_{op} < +125\text{ °C}$			450	
		TSX7191A, $V_{icm} = V_{CC}/2$			100	
		$T_{min} < T_{op} < +85\text{ °C}$			265	
		$T_{min} < T_{op} < +125\text{ °C}$			350	
$\Delta V_{io}/\Delta T$	Input offset voltage drift ⁽¹⁾				2.5	$\mu\text{V}/\text{°C}$
ΔV_{io}	Long term input offset voltage drift ⁽²⁾	$T = 25\text{ °C}$		500		$\frac{\text{nV}}{\sqrt{\text{month}}}$
I_{ib}	Input bias current ⁽¹⁾	$V_{out} = V_{CC}/2$		1	50	pA
		$T_{min} < T_{op} < T_{max}$			200	
I_{io}	Input offset current ⁽¹⁾	$V_{out} = V_{CC}/2$		1	50	pA
		$T_{min} < T_{op} < T_{max}$			200	
R_{IN}	Input resistance			1		$\text{T}\Omega$
C_{IN}	Input capacitance			12.5		pF
CMRR	Common mode rejection ratio 20 log ($\Delta V_{icm}/\Delta V_{io}$)	$V_{icm} = -0.1\text{ to }16.1\text{ V}$, $V_{out} = V_{CC}/2$	94	113		dB
		$T_{min} < T_{op} < T_{max}$	90			
		$V_{icm} = -0.1\text{ to }14\text{ V}$, $V_{out} = V_{CC}/2$	110	116		
		$T_{min} < T_{op} < T_{max}$	96			
SVRR	Supply voltage rejection ratio 20 log ($\Delta V_{cc}/\Delta V_{io}$)	$V_{cc} = 4\text{ to }16\text{ V}$	100	131		dB
		$T_{min} < T_{op} < T_{max}$	90			
A_{vd}	Large signal voltage gain	$R_L = 2\text{ k}\Omega$, $V_{out} = 0.3\text{ to }15.7\text{ V}$	110	146		dB
		$T_{min} < T_{op} < T_{max}$	100			
		$R_L = 10\text{ k}\Omega$, $V_{out} = 0.2\text{ to }15.8\text{ V}$	110	149		
		$T_{min} < T_{op} < T_{max}$	100			
V_{OH}	High level output voltage (voltage drop from V_{CC+})	$R_L = 2\text{ k}\Omega$		100	130	mV
		$T_{min} < T_{op} < T_{max}$			150	
		$R_L = 10\text{ k}\Omega$		16	40	
		$T_{min} < T_{op} < T_{max}$			50	
V_{OL}	Low level output voltage	$R_L = 2\text{ k}\Omega$		70	130	mV
		$T_{min} < T_{op} < T_{max}$			150	
		$R_L = 10\text{ k}\Omega$		15	40	
		$T_{min} < T_{op} < T_{max}$			50	

Electrical characteristics

TSX7191, TSX7191A

Symbol	Parameter	Conditions	Min.	Typ.	Max.	Unit
I_{out}	I_{sink}	$V_{out} = V_{CC}$	50	71		mA
		$T_{min} < T_{op} < T_{max}$	45			
	I_{source}	$V_{out} = 0\text{ V}$	50	68		
		$T_{min} < T_{op} < T_{max}$	45			
I_{CC}	Supply current per amplifier	No load, $V_{out} = V_{CC}/2$		660	900	μA
		$T_{min} < T_{op} < T_{max}$			1000	
GBP	Gain bandwidth product	$R_L = 10\text{ k}\Omega$, $C_L = 100\text{ pF}$	5	8.5		MHz
ϕ_m	Phase margin	$G = 10$, $R_L = 10\text{ k}\Omega$, $C_L = 100\text{ pF}$		51		Degrees
SRn	Negative slew rate	$A_v = 10$, $V_{out} = 10\text{ V}_{PP}$, 10 % to 90 %	1.5	2.4		V/ μs
		$T_{min} < T_{op} < T_{max}$	1.1			
SRp	Positive slew rate	$A_v = 10$, $V_{out} = 10\text{ V}_{PP}$, 10 % to 90 %	1.5	2.5		
		$T_{min} < T_{op} < T_{max}$	1.1			
e_n	Equivalent input noise voltage	$f = 1\text{ kHz}$		22		$\frac{\text{nV}}{\sqrt{\text{Hz}}}$
		$f = 10\text{ kHz}$		19		
THD+N	Total harmonic distortion + Noise	$f = 1\text{ kHz}$, $A_v = 10$, $R_L = 10\text{ k}\Omega$, $BW = 22\text{ kHz}$, $V_{out} = 10\text{ V}_{PP}$		0.0001		%

Notes:

⁽¹⁾Maximum values are guaranteed by design.

⁽²⁾Typical value is based on the V_{io} drift observed after 1000h at 125 °C extrapolated to 25 °C using the Arrhenius law and assuming an activation energy of 0.7 eV. The operational amplifier is aged in follower mode configuration (see [Section 4.6](#)).

Figure 2: Supply current vs. supply voltage

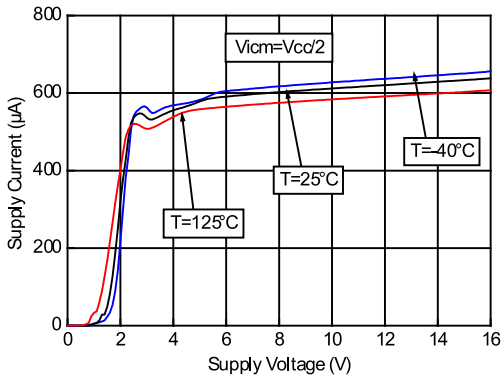

Figure 3: Input offset voltage distribution at $V_{CC} = 16\text{ V}$

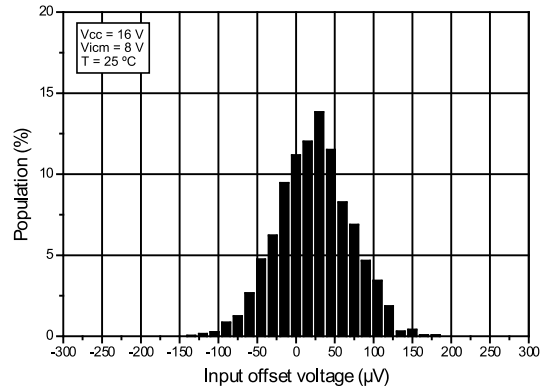

Figure 4: Input offset voltage distribution at $V_{CC} = 4\text{ V}$

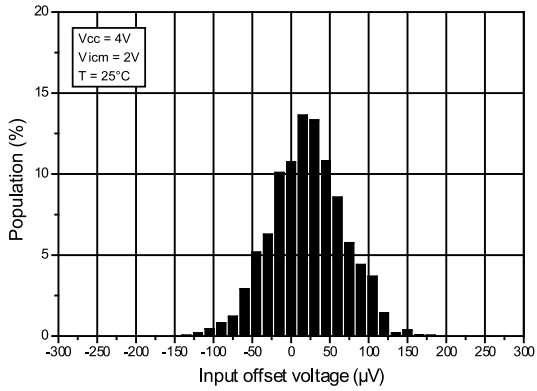

Figure 5: Input offset voltage vs. temperature at $V_{CC} = 16\text{ V}$

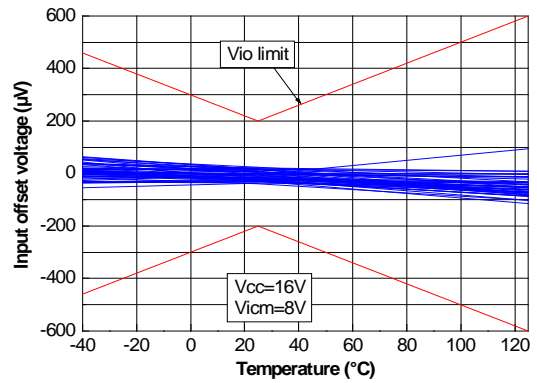

Figure 6: Input offset voltage drift population



Figure 7: Input offset voltage vs. supply voltage at $V_{ICM} = 0\text{ V}$



Figure 8: Input offset voltage vs. common mode voltage at $V_{CC} = 2.7\text{ V}$

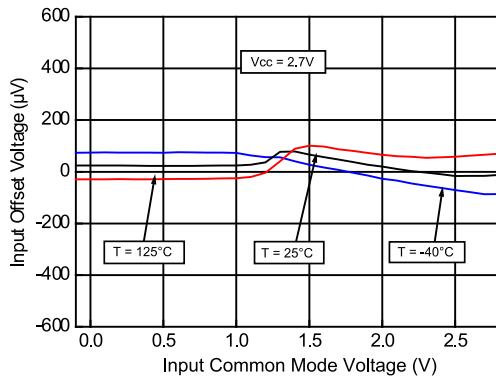

Figure 9: Input offset voltage vs. common mode voltage at $V_{CC} = 16\text{ V}$

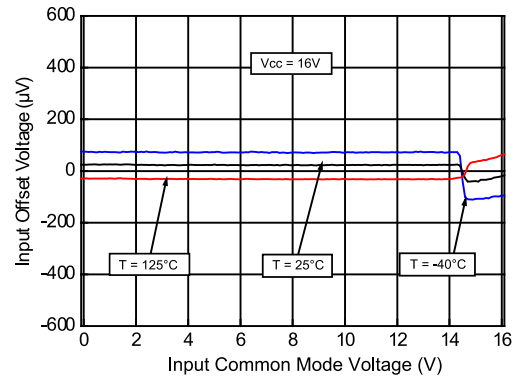

Figure 10: Output current vs. output voltage at $V_{CC} = 2.7\text{ V}$

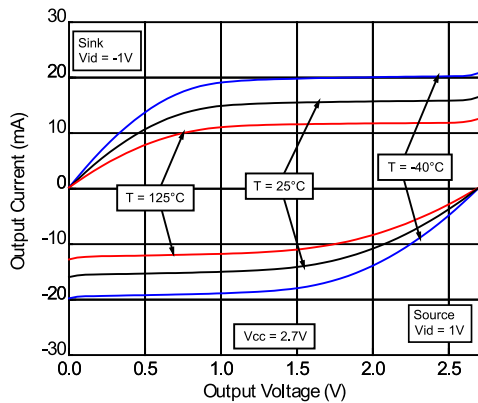

Figure 11: Output current vs. output voltage at $V_{CC} = 16\text{ V}$

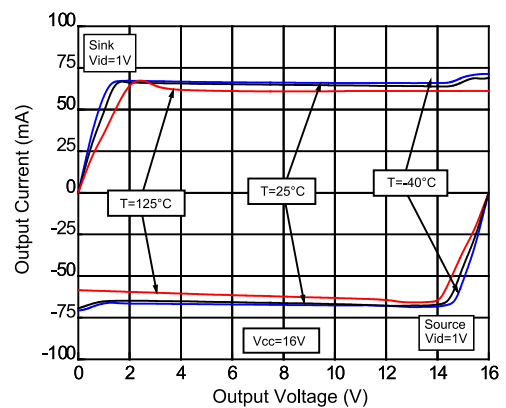

Figure 12: Output low voltage vs. supply voltage

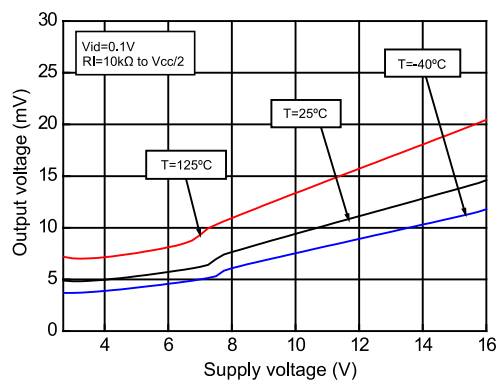

Figure 13: Output high voltage (drop from V_{CC+}) vs. supply voltage

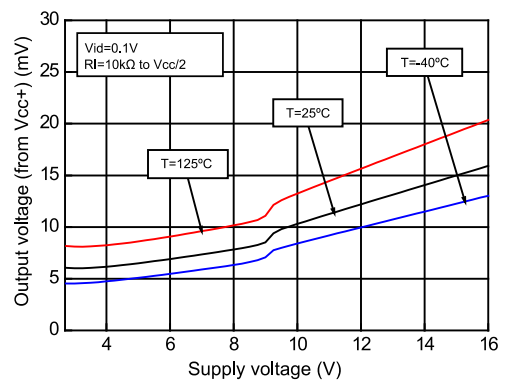

Figure 14: Output voltage vs. input voltage close to the rail at $V_{CC} = 16\text{ V}$



Figure 15: Slew rate vs. supply voltage

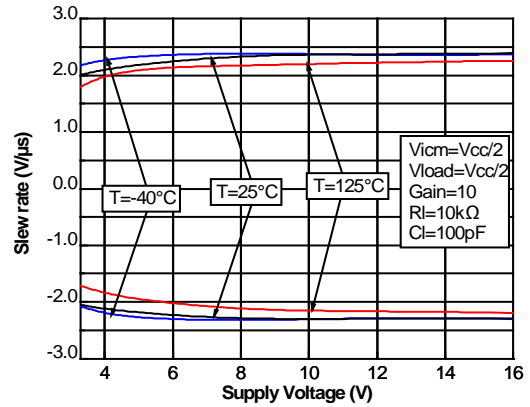

Figure 16: Negative slew rate at $V_{CC} = 16\text{ V}$

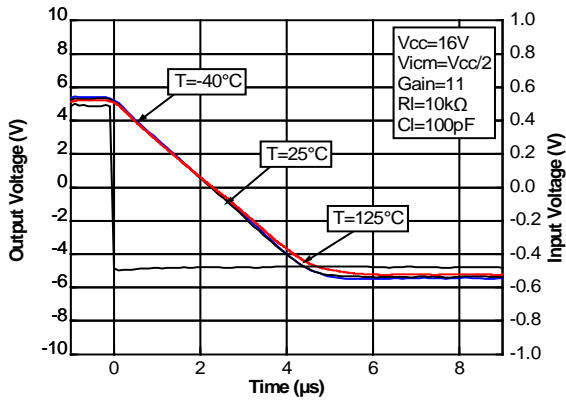

Figure 17: Positive slew rate at $V_{CC} = 16\text{ V}$

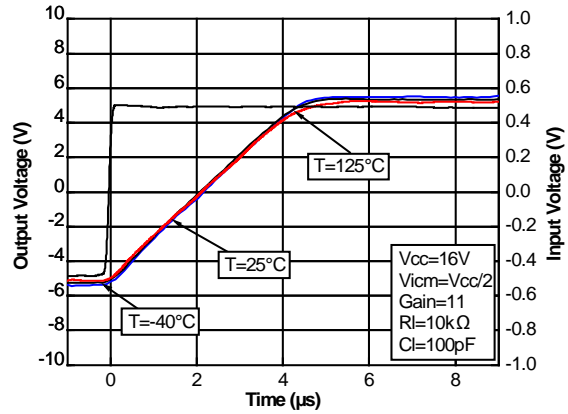

Figure 18: Response to a small input voltage step



Figure 19: Recovery behavior after a negative step on the input



Figure 20: Recovery behavior after a positive step on the input

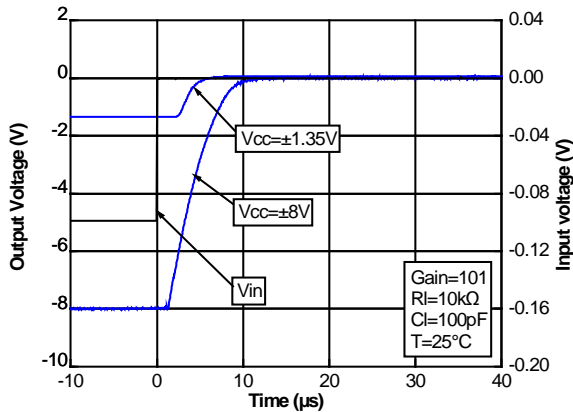

Figure 21: Bode diagram at $V_{CC} = 2.7\text{ V}$

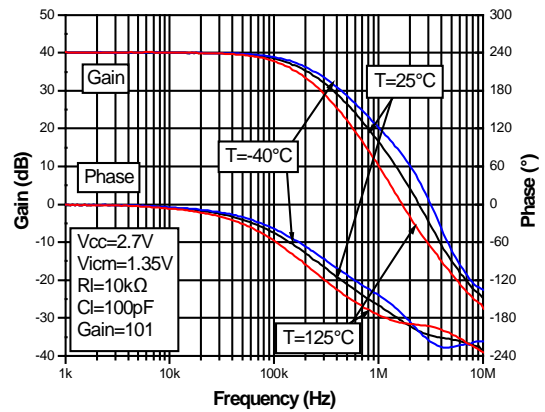

Figure 22: Bode diagram at $V_{CC} = 16\text{ V}$

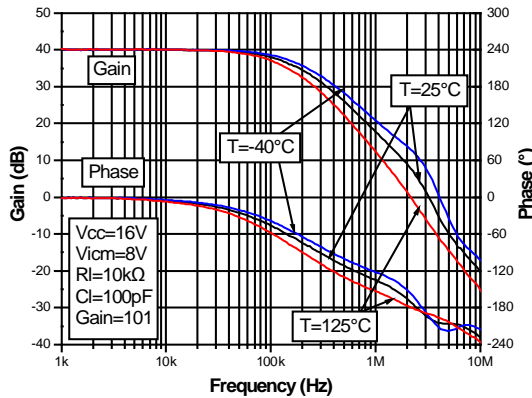

Figure 23: Power supply rejection ratio (PSRR) vs. frequency

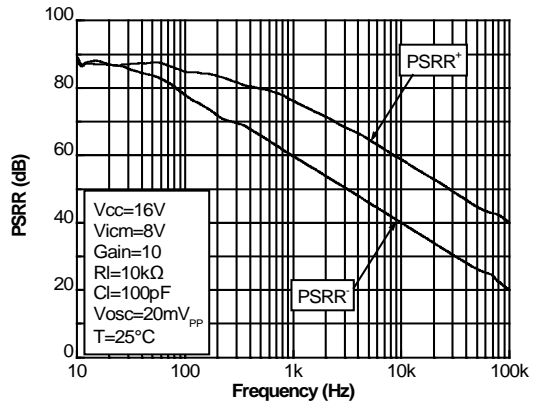

Figure 24: Output overshoot vs. capacitive load

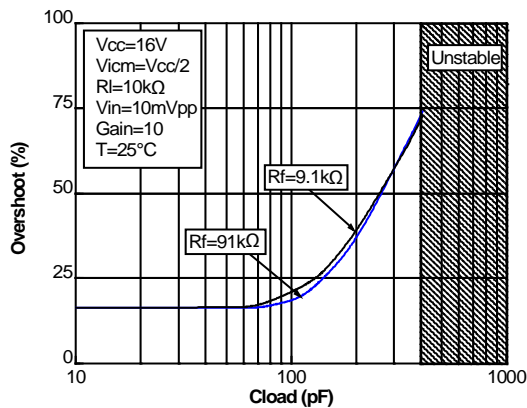

Figure 25: Output impedance vs. frequency in closed loop configuration





4 Application information

4.1 Operating voltages

The TSX7191, TSX7191A device can operate from 2.7 to 16 V. The parameters are fully specified for 4 V, 10 V, and 16 V power supplies. However, the parameters are very stable in the full V_{CC} range. Additionally, the main specifications are guaranteed in extended temperature ranges from -40 to +125 °C.

4.2 Input pin voltage ranges

The TSX7191, TSX7191A device has internal ESD diode protection on the inputs. These diodes are connected between the input and each supply rail to protect the input MOSFETs from electrical discharge.

If the input pin voltage exceeds the power supply by 0.5 V, the ESD diodes become conductive and excessive current can flow through them. Without limitation this over current can damage the device.

In this case, it is important to limit the current to 10 mA, by adding resistance on the input pin, as described in [Figure 30](#).

Figure 30: Input current limitation



4.3 Rail-to-rail input

The TSX7191, TSX7191A device has a rail-to-rail input, and the input common mode range is extended from $V_{CC-} - 0.1$ V to $V_{CC+} + 0.1$ V.

4.4 Rail-to-rail output

The operational amplifier output levels can go close to the rails: to a maximum of 30 mV above and below the rail when connected to a 10 k Ω resistive load to $V_{CC}/2$.

4.5 Input offset voltage drift over temperature

The maximum input voltage drift variation over temperature is defined as the offset variation related to the offset value measured at 25 °C. The operational amplifier is one of the main circuits of the signal conditioning chain, and the amplifier input offset is a major contributor to the chain accuracy. The signal chain accuracy at 25 °C can be compensated during production at application level. The maximum input voltage drift over temperature enables the system designer to anticipate the effect of temperature variations.

The maximum input voltage drift over temperature is computed using [Equation 1](#).

Equation 1

$$\frac{\Delta V_{io}}{\Delta T} = \max \left| \frac{V_{io}(T) - V_{io}(25\text{ °C})}{T - 25\text{ °C}} \right|$$

Where T = -40 °C and 125 °C.

The TSX7191, TSX7191A datasheet maximum value is guaranteed by measurements on a representative sample size ensuring a C_{pk} (process capability index) greater than 1.3.

4.6 Long term input offset voltage drift

To evaluate product reliability, two types of stress acceleration are used:

- Voltage acceleration, by changing the applied voltage
- Temperature acceleration, by changing the die temperature (below the maximum junction temperature allowed by the technology) with the ambient temperature.

The voltage acceleration has been defined based on JEDEC results, and is defined using [Equation 2](#).

Equation 2

$$A_{FV} = e^{\beta \cdot (V_S - V_U)}$$

Where:

A_{FV} is the voltage acceleration factor

β is the voltage acceleration constant in 1/V, constant technology parameter ($\beta = 1$)

V_S is the stress voltage used for the accelerated test

V_U is the voltage used for the application

The temperature acceleration is driven by the Arrhenius model, and is defined in [Equation 3](#).

Equation 3

$$A_{FT} = e^{\frac{E_a}{k} \cdot \left(\frac{1}{T_U} - \frac{1}{T_S} \right)}$$

Where:

A_{FT} is the temperature acceleration factor

E_a is the activation energy of the technology based on the failure rate

k is the Boltzmann constant ($8.6173 \times 10^{-5} \text{ eV.K}^{-1}$)

T_U is the temperature of the die when V_U is used (K)

T_S is the temperature of the die under temperature stress (K)

The final acceleration factor, A_F , is the multiplication of the voltage acceleration factor and the temperature acceleration factor ([Equation 4](#)).

Equation 4

$$A_F = A_{FT} \times A_{FV}$$

A_F is calculated using the temperature and voltage defined in the mission profile of the product. The A_F value can then be used in [Equation 5](#) to calculate the number of months of use equivalent to 1000 hours of reliable stress duration.

Equation 5

$$\text{Months} = A_F \times 1000 \text{ h} \times 12 \text{ months} / (24 \text{ h} \times 365.25 \text{ days})$$

To evaluate the op amp reliability, a follower stress condition is used where V_{CC} is defined as a function of the maximum operating voltage and the absolute maximum rating (as recommended by JEDEC rules).

The V_{io} drift (in μV) of the product after 1000 h of stress is tracked with parameters at different measurement conditions (see [Equation 6](#)).

Equation 6

$$V_{CC} = \max V_{op} \text{ with } V_{icm} = V_{CC} / 2$$

The long term drift parameter (ΔV_{io}), estimating the reliability performance of the product, is obtained using the ratio of the V_{io} (input offset voltage value) drift over the square root of the calculated number of months ([Equation 7](#)).

Equation 7

$$\Delta V_{io} = \frac{V_{io} \text{ drift}}{\sqrt{(\text{months})}}$$

Where V_{io} drift is the measured drift value in the specified test conditions after 1000 h stress duration.

4.7 High values of input differential voltage

In a closed loop configuration, which represents the typical use of an op amp, the input differential voltage is low (close to V_{io}). However, some specific conditions can lead to higher input differential values, such as:

- operation in an output saturation state
- operation at speeds higher than the device bandwidth, with output voltage dynamics limited by slew rate.
- use of the amplifier in a comparator configuration, hence in open loop

Use of the TSX7191, TSX7191A in comparator configuration, especially combined with high temperature and long duration can create a permanent drift of V_{io} .

4.8 Capacitive load

Driving large capacitive loads can cause stability problems. Increasing the load capacitance produces gain peaking in the frequency response, with overshoot and ringing in the step response. It is usually considered that with a gain peaking higher than 2.3 dB an op amp might become unstable.

Generally, the unity gain configuration is the worst case for stability and the ability to drive large capacitive loads.

Figure 31 shows the serial resistor that must be added to the output, to make a system stable. Figure 32 shows the test configuration using an isolation resistor, Riso.

Figure 31: Stability criteria with a serial resistor at different supply voltages



Figure 32: Test configuration for Riso



4.9 PCB layout recommendations

Particular attention must be paid to the layout of the PCB, tracks connected to the amplifier, load, and power supply. The power and ground traces are critical as they must provide adequate energy and grounding for all circuits. The best practice is to use short and wide PCB traces to minimize voltage drops and parasitic inductance.

In addition, to minimize parasitic impedance over the entire surface, a multi-via technique that connects the bottom and top layer ground planes together in many locations is often used.

The copper traces that connect the output pins to the load and supply pins should be as wide as possible to minimize trace resistance.

4.10 Optimized application recommendation

It is recommended to place a 22 nF capacitor as close as possible to the supply pin. A good decoupling will help to reduce electromagnetic interference impact.

5 Package information

In order to meet environmental requirements, ST offers these devices in different grades of ECOPACK® packages, depending on their level of environmental compliance. ECOPACK® specifications, grade definitions and product status are available at: www.st.com. ECOPACK® is an ST trademark.

5.1 SOT23-5 package information

Figure 33: SOT23-5 package outline



Table 6: SOT23-5 mechanical data

Ref.	Dimensions					
	Millimeters			Inches		
	Min.	Typ.	Max.	Min.	Typ.	Max.
A	0.90	1.20	1.45	0.035	0.047	0.057
A1			0.15			0.006
A2	0.90	1.05	1.30	0.035	0.041	0.051
B	0.35	0.40	0.50	0.014	0.016	0.020
C	0.09	0.15	0.20	0.004	0.006	0.008
D	2.80	2.90	3.00	0.110	0.114	0.118
D1		1.90			0.075	
e		0.95			0.037	
E	2.60	2.80	3.00	0.102	0.110	0.118
F	1.50	1.60	1.75	0.059	0.063	0.069
L	0.10	0.35	0.60	0.004	0.014	0.024
K	0 degrees		10 degrees	0 degrees		10 degrees

6 Ordering information

Table 7: Order codes

Order code	Temperature range	Package	Packaging	Marking
TSX7191ILT	-40 to +125 °C	SOT23-5	Tape and reel	K34
TSX7191AILT				K196
TSX7191IYLT ⁽¹⁾				K199
TSX7191AIYLT ⁽¹⁾				K200

Notes:

⁽¹⁾Qualification and characterization according to AEC Q100 and Q003 or equivalent, advanced screening according to AEC Q001 & Q 002 or equivalent are on-going.

7 Revision history

Table 8: Document revision history

Date	Revision	Changes
29-Sep-2014	1	Initial release
06-Jan-2015	2	Features: updated "stable when used with gain" feature. Applications: removed "DAC buffer" Electrical characteristics: replaced Figure 14
17-Mar-2017	3	Added part number TSX7191A

IMPORTANT NOTICE – PLEASE READ CAREFULLY

STMicroelectronics NV and its subsidiaries ("ST") reserve the right to make changes, corrections, enhancements, modifications, and improvements to ST products and/or to this document at any time without notice. Purchasers should obtain the latest relevant information on ST products before placing orders. ST products are sold pursuant to ST's terms and conditions of sale in place at the time of order acknowledgement.

Purchasers are solely responsible for the choice, selection, and use of ST products and ST assumes no liability for application assistance or the design of Purchasers' products.

No license, express or implied, to any intellectual property right is granted by ST herein.

Resale of ST products with provisions different from the information set forth herein shall void any warranty granted by ST for such product.

ST and the ST logo are trademarks of ST. All other product or service names are the property of their respective owners.

Information in this document supersedes and replaces information previously supplied in any prior versions of this document.

© 2017 STMicroelectronics – All rights reserved