

PTFB193404F

Thermally-Enhanced High Power RF LDMOS FET 340 W, 30 V, 1930 – 1990 MHz

Description

The PTFB193404F is a 340-watt LDMOS FET intended for use in multi-standard cellular power amplifier applications in the 1930 to 1990 MHz frequency band. Features include input and output matching, high gain and thermally-enhanced package with earless flange. Manufactured with Wolfspeed's advanced LDMOS process, this device provides excellent thermal performance and superior reliability.

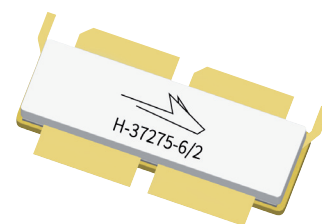

PTFB193404F
Package H-37275-6/2

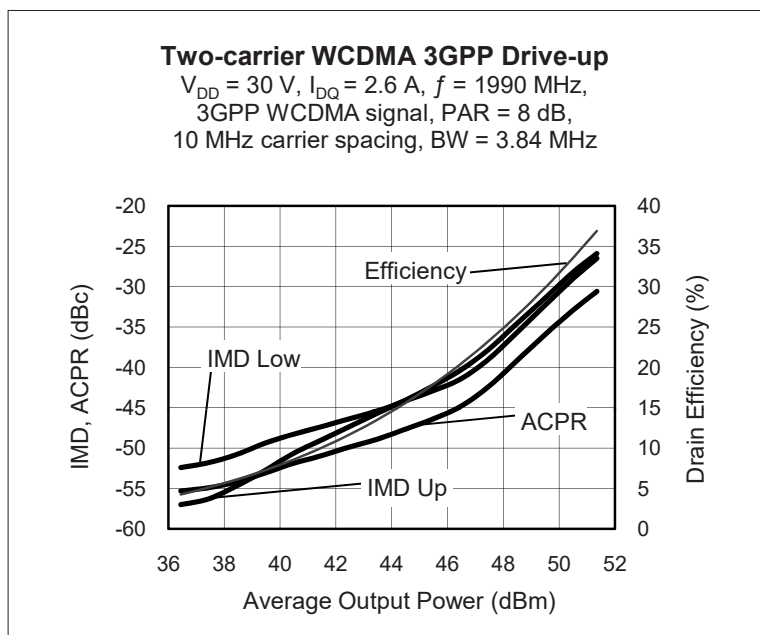

Features

- Broadband internal matching
- Wide video bandwidth
- Typical single-carrier WCDMA performance, 1990 MHz, 30 V
 - Output power = 100 W
 - Efficiency = 33%
 - Gain = 19 dB
 - PAR = 7.5 dB @ 0.01% CCDF
 - ACPR @ 5 MHz = -35 dBc
- Increased negative gate-source voltage range for improved performance in Doherty amplifiers
- Capable of handling 10:1 VSWR @ 30 V, 340 W (CW) output power
- Integrated ESD protection
- Excellent thermal stability
- Pb-free and RoHS compliant

RF Characteristics

Single-carrier WCDMA Measurements (tested in Wolfspeed test fixture)

$V_{DD} = 30\text{ V}$, $I_{DQ} = 2.6\text{ A}$, $P_{OUT} = 80\text{ W}$ average, $f = 1990\text{ MHz}$,
 3GPP signal, channel bandwidth = 3.84 MHz, peak/average = 10.0 dB @ 0.01% CCDF

Characteristic	Symbol	Min	Typ	Max	Unit
Gain	G_{ps}	17.5	19	—	dB
Drain Efficiency	η_D	29	33	—	%
Adjacent Channel Power Ratio	ACPR	—	-34.5	-32.5	dBc

All published data at $T_{CASE} = 25^\circ\text{C}$ unless otherwise indicated

ESD: Electrostatic discharge sensitive device—observe handling precautions!

RF Characteristics (cont.)

Two-carrier WCDMA Characteristics (not subject to production test—verified by design/characterization in Wolfspeed test fixture)
 $V_{DD} = 30\text{ V}$, $I_{DQ} = 2.6\text{ A}$, $P_{OUT} = 80\text{ W}$ average, $f_1 = 1980\text{ MHz}$, $f_2 = 1990\text{ MHz}$, 3GPP signal, channel bandwidth = 3.84 MHz, peak/average = 8.0 dB @ 0.01% CCDF

Characteristic	Symbol	Min	Typ	Max	Unit
Gain	G_{ps}	—	19	—	dB
Drain Efficiency	η_D	—	29	—	%
Intermodulation Distortion	IMD	—	-33	—	dBc

Two-tone Characteristics (not subject to production test—verified by design/characterization in Wolfspeed test fixture)
 $V_{DD} = 30\text{ V}$, $I_{DQ} = 2.6\text{ A}$, $P_{OUT} = 265\text{ W}$ PEP, $f = 1990\text{ MHz}$, tone spacing = 1 MHz

Characteristic	Symbol	Min	Typ	Max	Unit
Gain	G_{ps}	—	19	—	dB
Drain Efficiency	η_D	—	36	—	%
Intermodulation Distortion	IMD	—	30	—	dBc

DC Characteristics (both sides)

Characteristic	Conditions	Symbol	Min	Typ	Max	Unit
Drain-Source Breakdown Voltage	$V_{GS} = 0\text{ V}$, $I_{DS} = 10\text{ mA}$	$V_{(BR)DSS}$	65	—	—	V
Drain Leakage Current	$V_{DS} = 28\text{ V}$, $V_{GS} = 0\text{ V}$	I_{DSS}	—	—	1.0	μA
	$V_{DS} = 63\text{ V}$, $V_{GS} = 0\text{ V}$	I_{DSS}	—	—	10.0	μA
On-State Resistance	$V_{GS} = 10\text{ V}$, $V_{DS} = 0.1\text{ V}$	$R_{DS(on)}$	—	0.05	—	Ω
Operating Gate Voltage	$V_{DS} = 30\text{ V}$, $I_{DQ} = 2.6\text{ A}$	V_{GS}	2.3	2.8	3.3	V
Gate Leakage Current	$V_{GS} = 10\text{ V}$, $V_{DS} = 0\text{ V}$	I_{GSS}	—	—	1.0	μA

Maximum Ratings

Parameter	Symbol	Value	Unit
Drain-Source Voltage	V_{DSS}	65	V
Gate-Source Voltage	V_{GS}	-6 to +10	V
Junction Temperature	T_J	200	$^{\circ}\text{C}$
Storage Temperature Range	T_{STG}	-40 to +150	$^{\circ}\text{C}$
Thermal Resistance ($T_{CASE} = 70^{\circ}\text{C}$)	$R_{\theta JC}$	0.2	$^{\circ}\text{C/W}$



Ordering Information

Type and Version	Order Code	Package Description	Shipping
PTFB193404F V1 R0	PTFB193404F-V1-R0	H-37275-6/2, earless flange	Tape & reel, 50 pcs
PTFB193404F V1 R250	PTFB193404F-V1-R250	H-37275-6/2, earless flange	Tape & reel, 250 pcs

Typical Performance (data taken in production test fixture)

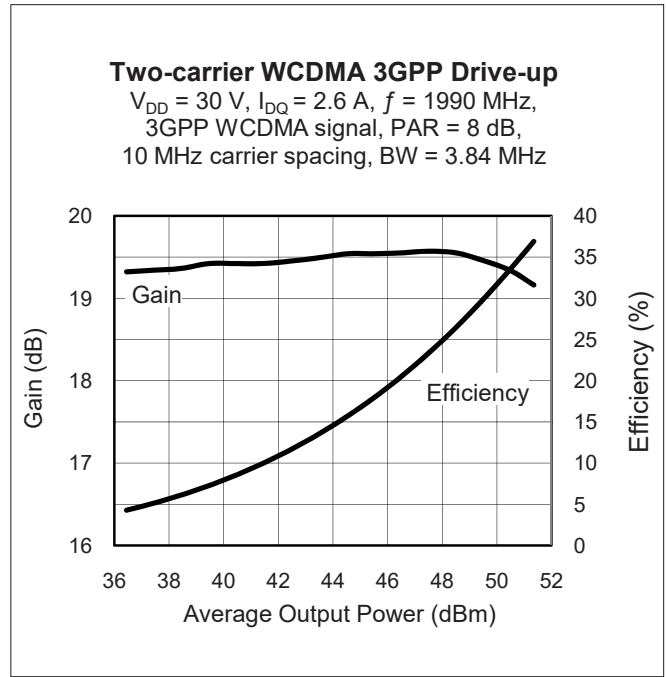
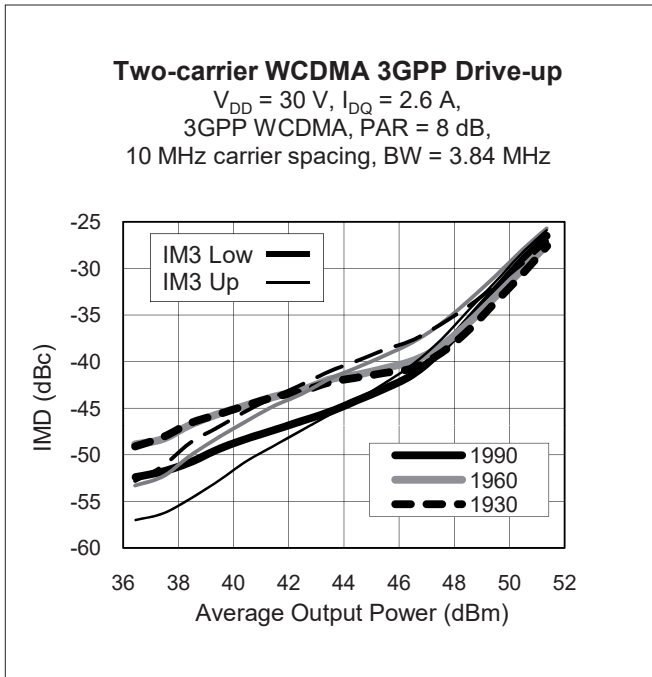

Typical Performance (cont.)

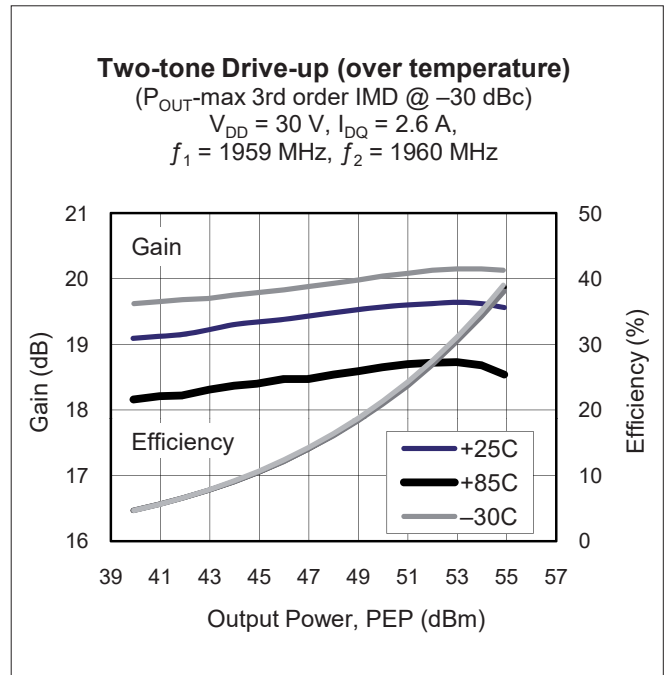
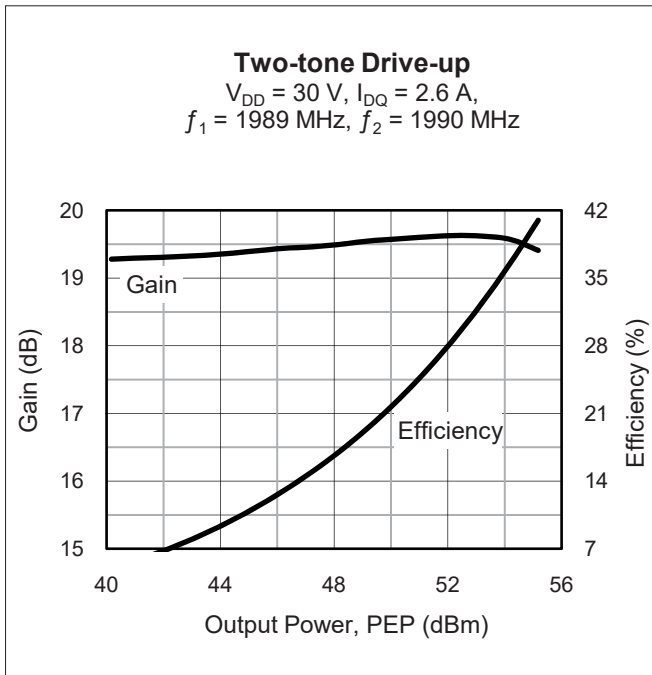
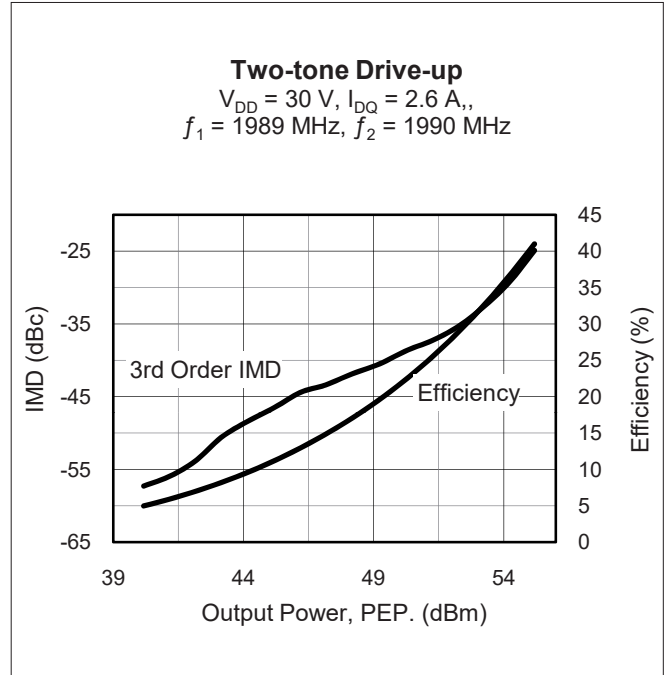
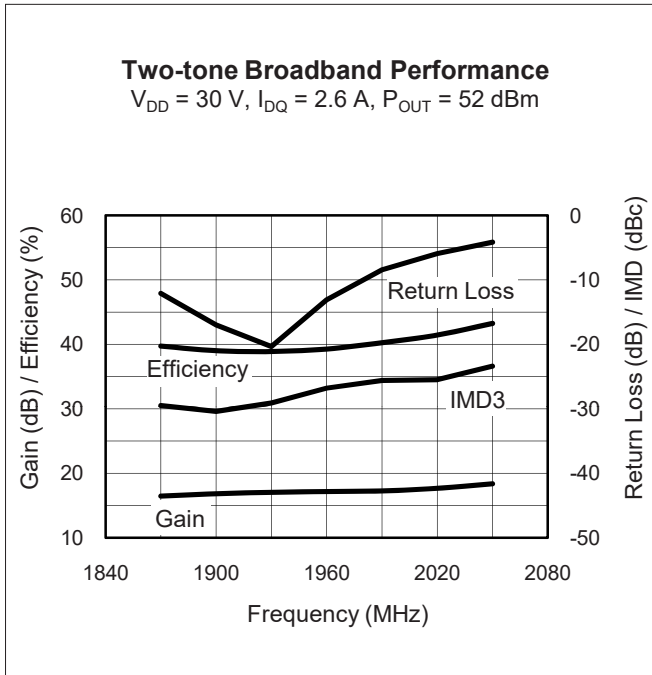

Typical Performance (cont.)

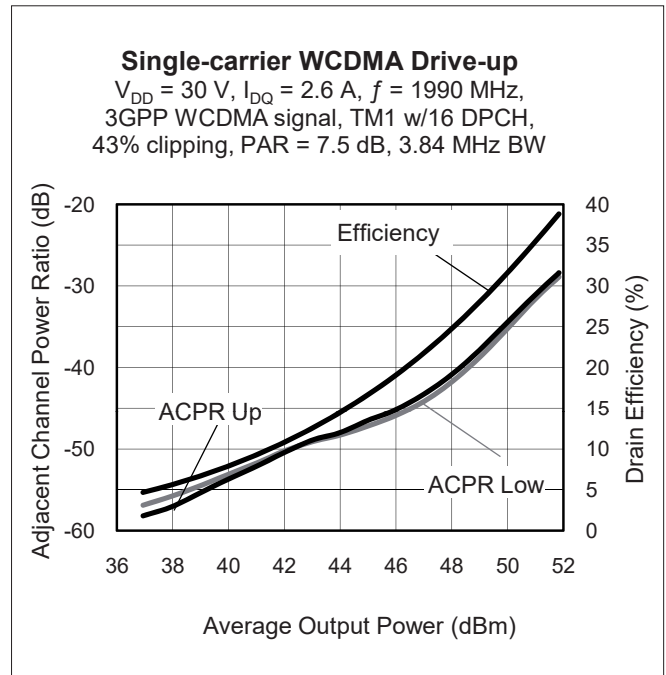
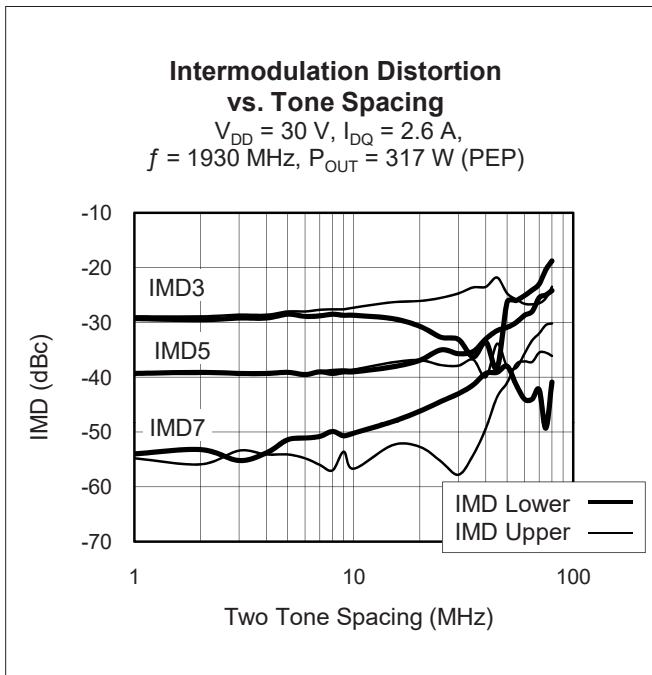
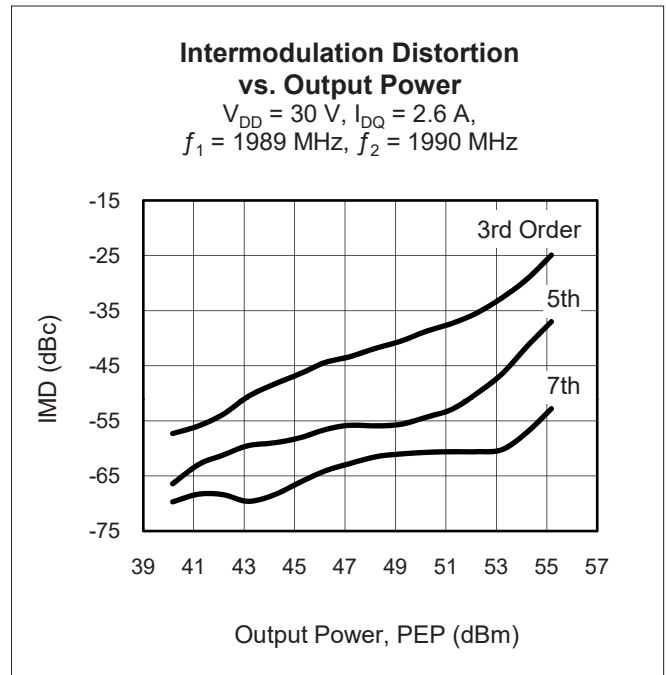
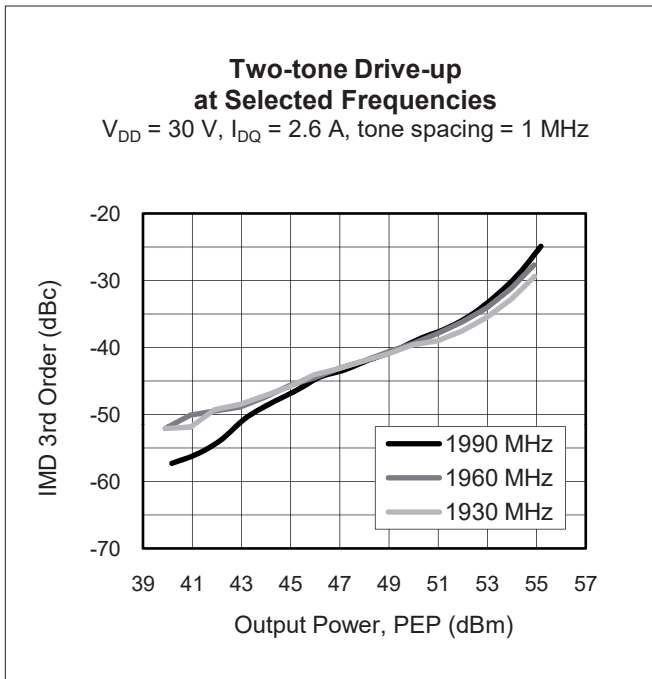

Typical Performance (cont.)

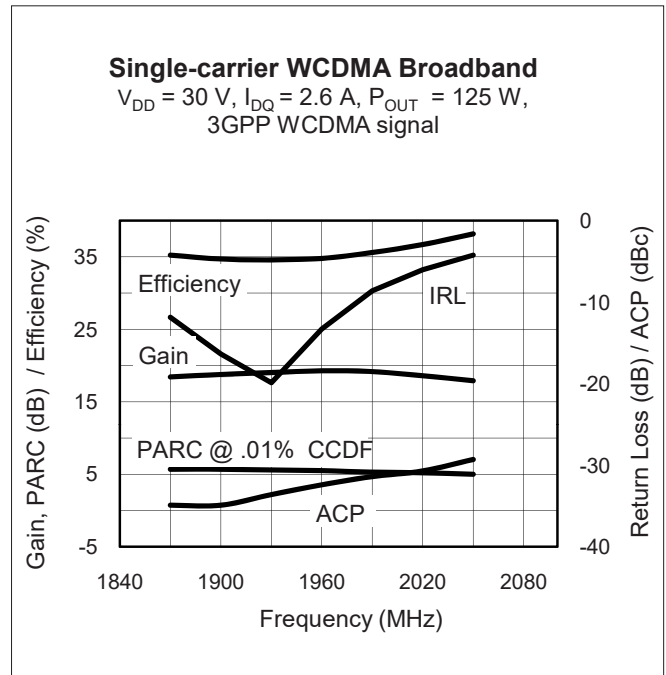
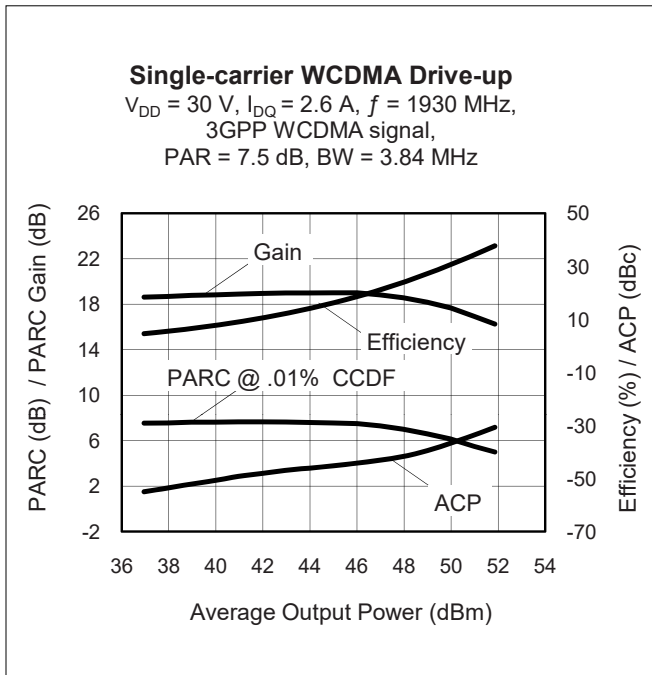
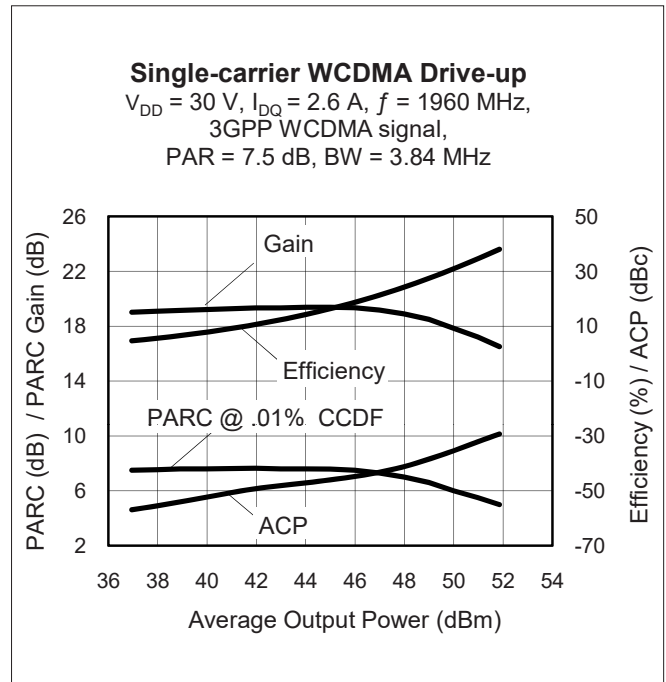
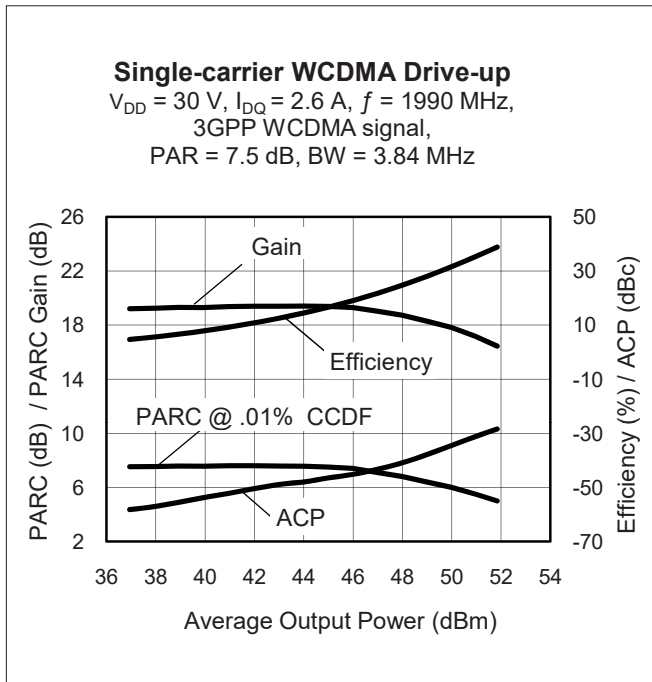

Broadband Circuit Impedance (measurements taken on full part, both sides)

Frequency	Z Source Ω		Z Load Ω	
	R	jX	R	jX
1900	1.21	-3.60	0.73	-2.08
1930	1.21	-3.53	0.72	-2.01
1960	1.20	-3.47	0.72	-1.94
1990	1.20	-3.41	0.72	-1.87
2020	1.19	-3.35	0.72	-1.81

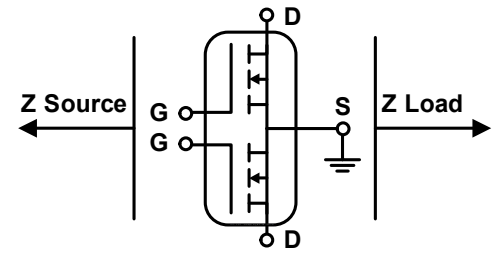

See next page for circuit information

Reference Circuit

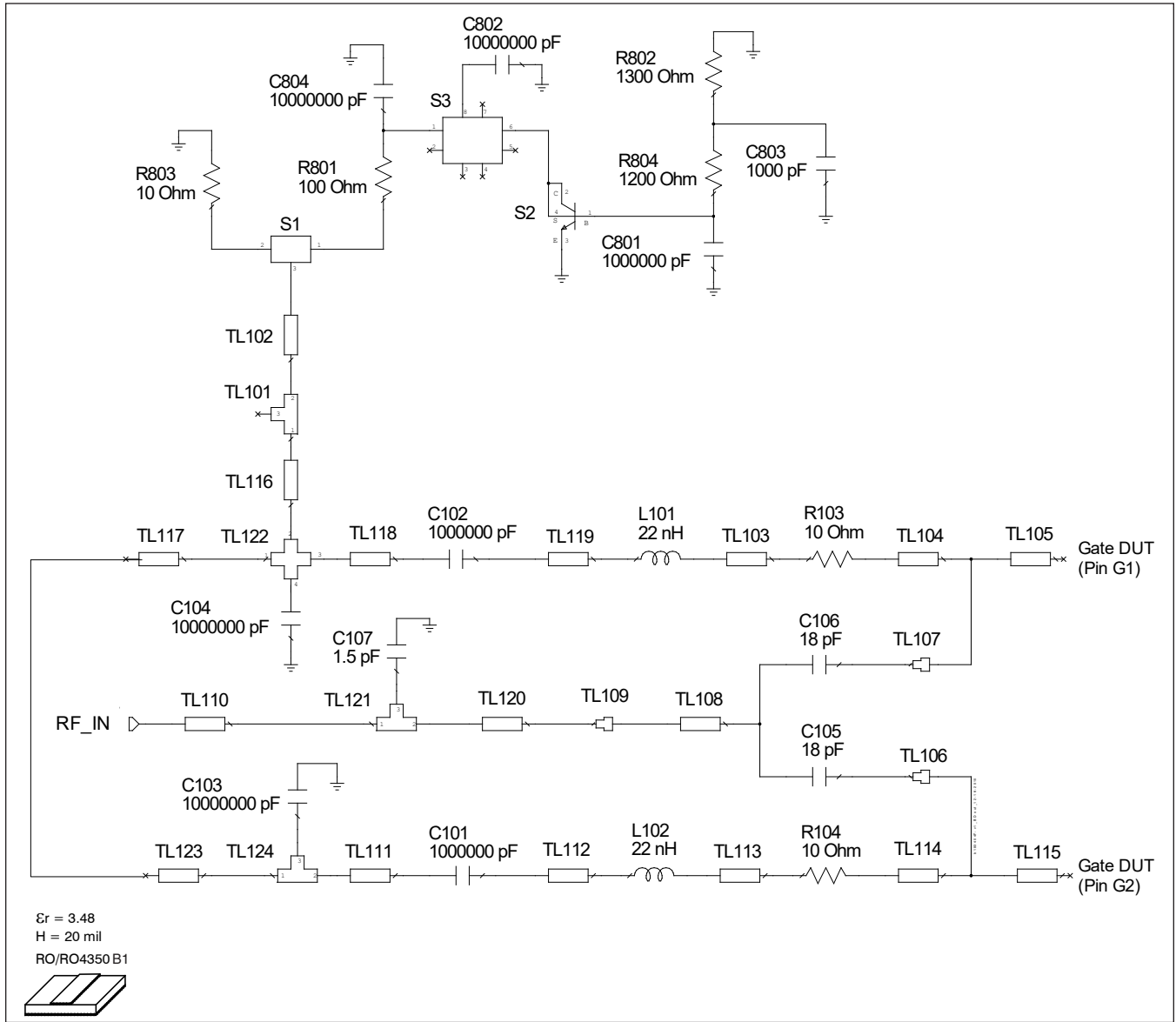

Reference circuit input schematic for $f = 1990 \text{ MHz}$

Reference Circuit (cont.)

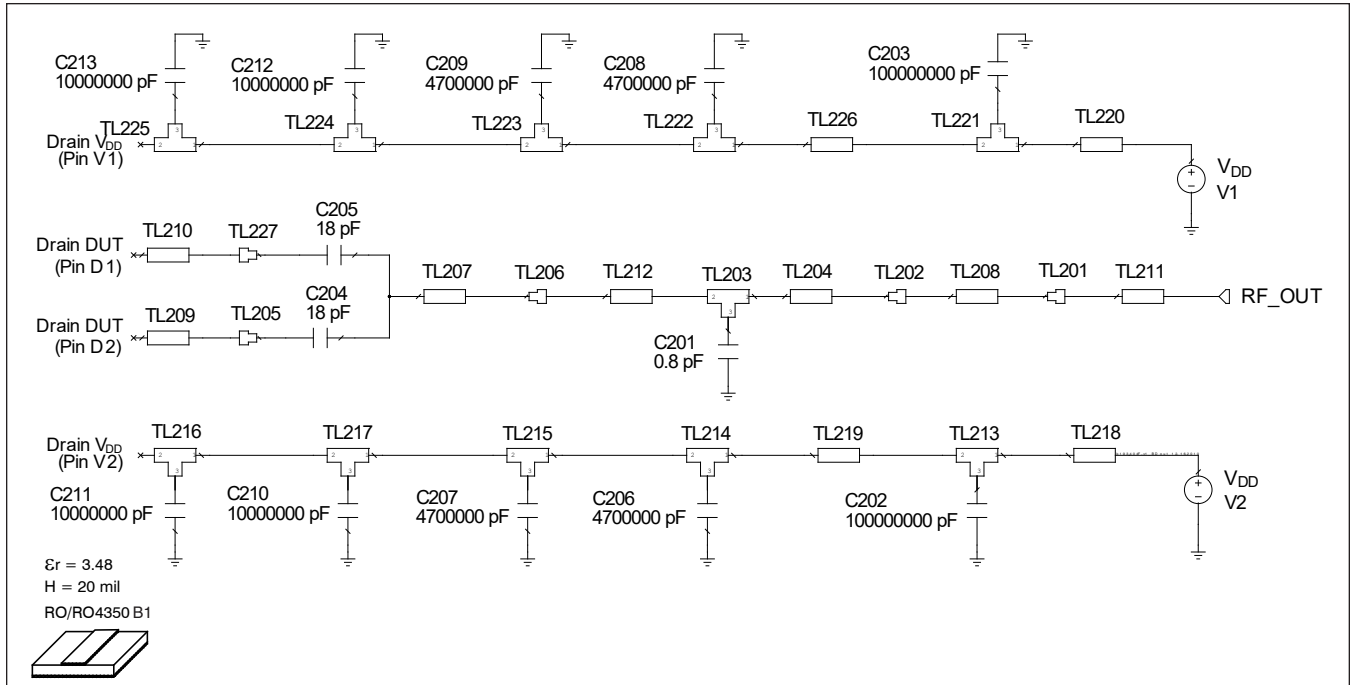

Reference circuit output schematic for $f = 1990$ MHz

Reference Circuit Assembly

DUT	PTFB193404F
Test Fixture Part No.	LTN/PTFB193404EF
PCB	Rogers RO4350, 0.508 mm [0.020"] thick, 1 oz. copper, $\epsilon_r = 3.48$
Find Gerber files for this test fixture on the Wolfspeed Web site at www.wolfspeed.com/RF	

Transmission Line	Electrical Characteristics	Dimensions: W, L (mm)	Dimensions: W, L (mils)
Input			
TL101	0.017λ , 47.12Ω	$W1 = 1.270$, $W2 = 1.270$, $W3 = 1.524$	$W1 = 50$, $W2 = 50$, $W3 = 60$
TL102	0.039λ , 47.12Ω	$W = 1.270$, $L = 3.553$	$W = 50$, $L = 140$
TL103	0.023λ , 47.12Ω	$W = 1.270$, $L = 2.055$	$W = 50$, $L = 81$
TL104	0.013λ , 47.12Ω	$W = 1.270$, $L = 1.168$	$W = 50$, $L = 46$
TL105	0.122λ , 7.29Ω	$W = 12.700$, $L = 10.160$	$W = 500$, $L = 400$
TL106		$W1 = 0.010$, $W2 = 1.168$, $\text{Offset} = 5.893$	$W1 = 10$, $W2 = 46$, $\text{Offset} = 232$
TL107		$W1 = 0.010$, $W2 = 1.168$, $\text{Offset} = -5.893$	$W1 = 10$, $W2 = 46$, $\text{Offset} = -232$
TL108	0.007λ , 34.08Ω	$W = 2.032$, $L = 0.635$	$W = 80$, $L = 25$
TL109	0.012λ , 34.08Ω	$W1 = 2.032$, $W2 = 1.034$	$W1 = 80$, $W2 = 41$
TL110	0.055λ , 53.60Ω	$W = 1.034$, $L = 5.029$	$W = 41$, $L = 198$
TL111	0.023λ , 47.12Ω	$W = 1.270$, $L = 2.111$	$W = 50$, $L = 83$
TL112	0.017λ , 47.12Ω	$W = 1.270$, $L = 1.524$	$W = 50$, $L = 60$
TL113	0.023λ , 47.12Ω	$W = 1.270$, $L = 2.055$	$W = 50$, $L = 81$

table continued on next page

Reference Circuit (cont.)

Transmission Line	Electrical Characteristics	Dimensions: W, L (mm)	Dimensions: W, L (mils)
Input (cont.)			
TL114	0.013 λ , 47.12 Ω	W = 1.270, L = 1.168	W = 50, L = 46
TL115	0.122 λ , 7.29 Ω	W = 12.700, L = 10.160	W = 500, L = 400
TL116	0.068 λ , 47.12 Ω	W = 1.270, L = 6.170	W = 50, L = 243
TL117	0.032 λ , 47.12 Ω	W = 1.270, L = 2.875	W = 50, L = 113
TL118	0.024 λ , 47.12 Ω	W = 1.270, L = 2.131	W = 50, L = 84
TL119	0.017 λ , 47.12 Ω	W = 1.270, L = 1.524	W = 50, L = 60
TL120	0.084 λ , 53.60 Ω	W = 1.034, L = 7.671	W = 41, L = 302
TL121	0.014 λ , 53.60 Ω	W1 = 1.034, W2 = 1.034, W3 = 1.27	W1 = 41, W2 = 41, W3 = 50
TL122	0.014 λ , 47.12 Ω	W1 = 1.270, W2 = 1.270, W3 = 1.270, W4 = 1.270	W1 = 50, W2 = 50, W3 = 50, W4 = 50
TL123	0.032 λ , 47.12 Ω	W = 1.270, L = 2.896	W = 50, L = 114
TL124	0.014 λ , 47.12 Ω	W1 = 1.270, W2 = 1.270, W3 = 1.27	W1 = 50, W2 = 50, W3 = 50
Output			
TL201		W1 = 1.577, W2 = 1.046	W1 = 62, W2 = 41
TL202		W1 = 2.263, W2 = 1.577	W1 = 89, W2 = 62
TL203	0.009 λ , 31.48 Ω	W1 = 2.263, W2 = 2.263, W3 = 0.762	W1 = 89, W2 = 89, W3 = 30
TL204	0.139 λ , 31.48 Ω	W = 2.263, L = 12.299	W = 89, L = 484
TL205		W1 = 0.001, W2 = 13.335, Offset = -6.223	W1 = 1, W2 = 525, Offset = -245
TL206		W1 = 3.048, W2 = 2.263	W1 = 120, W2 = 89
TL207	0.009 λ , 25.04 Ω	W = 3.048, L = 0.762	W = 120, L = 30
TL208	0.266 λ , 40.78 Ω	W = 1.577, L = 23.889	W = 62, L = 941
TL209	0.160 λ , 6.97 Ω	W = 13.335, L = 13.335	W = 525, L = 525
TL210	0.160 λ , 6.97 Ω	W = 13.335, L = 13.335	W = 525, L = 525
TL211	0.151 λ , 53.21 Ω	W = 1.046, L = 13.774	W = 41, L = 542
TL212	0.120 λ , 31.48 Ω	W = 2.263, L = 10.617	W = 89, L = 418
TL213	0.024 λ , 19.85 Ω	W1 = 4.064, W2 = 4.064, W3 = 2.032	W1 = 160, W2 = 160, W3 = 80
TL214	0.026 λ , 19.85 Ω	W1 = 4.064, W2 = 4.064, W3 = 2.286	W1 = 160, W2 = 160, W3 = 90
TL215	0.026 λ , 19.85 Ω	W1 = 4.064, W2 = 4.064, W3 = 2.286	W1 = 160, W2 = 160, W3 = 90
TL216	0.024 λ , 19.85 Ω	W1 = 4.064, W2 = 4.064, W3 = 2.032	W1 = 160, W2 = 160, W3 = 80
TL217	0.026 λ , 19.85 Ω	W1 = 4.064, W2 = 4.064, W3 = 2.286	W1 = 160, W2 = 160, W3 = 90
TL218	0.116 λ , 19.85 Ω	W = 4.064, L = 10.008	W = 160, L = 394
TL219	0.052 λ , 19.85 Ω	W = 4.064, L = 4.470	W = 160, L = 176
TL220	0.116 λ , 19.85 Ω	W = 4.064, L = 10.008	W = 160, L = 394
TL221	0.024 λ , 19.85 Ω	W1 = 4.064, W2 = 4.064, W3 = 2.032	W1 = 160, W2 = 160, W3 = 80
TL222	0.026 λ , 19.85 Ω	W1 = 4.064, W2 = 4.064, W3 = 2.286	W1 = 160, W2 = 160, W3 = 90
TL223	0.026 λ , 19.85 Ω	W1 = 4.064, W2 = 4.064, W3 = 2.286	W1 = 160, W2 = 160, W3 = 90
TL224	0.026 λ , 19.85 Ω	W1 = 4.064, W2 = 4.064, W3 = 2.286	W1 = 160, W2 = 160, W3 = 90
TL225	0.024 λ , 19.85 Ω	W1 = 4.064, W2 = 4.064, W3 = 2.032	W1 = 160, W2 = 160, W3 = 80
TL226	0.052 λ , 19.85 Ω	W = 4.064, L = 4.470	W = 160, L = 176
TL227		W1 = 0.001, W2 = 13.335, Offset = 6.223	W1 = 1, W2 = 525, Offset = 245

Reference Circuit (cont.)

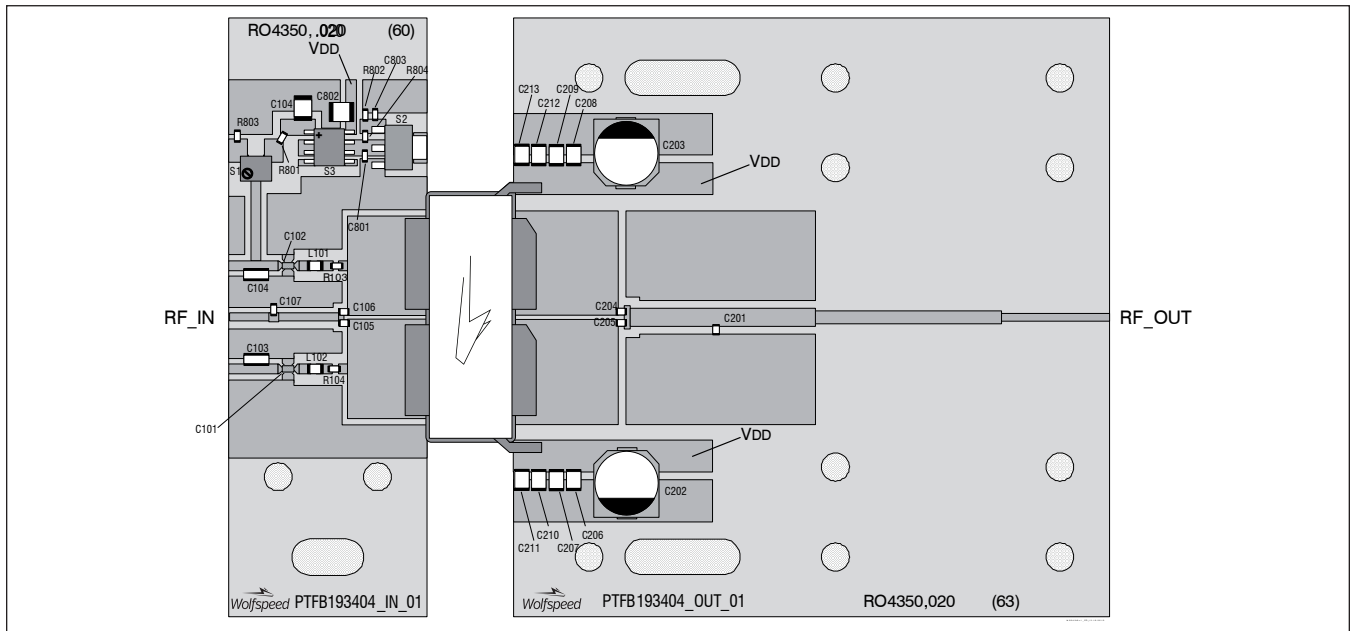

Reference circuit assembly diagram (not to scale)

Component ID	Description	Suggested Manufacturer	P/N
C101, C102	Chip capacitor, 1 μF	ATC	NFM18PS105R0J30
C103, C104	Capacitor, 10 μF	Digi-Key	490-4393-2-ND
C105, C106, C204, C205	Capacitor, 18 pF	ATC	800A180JT
C107	Capacitor, 1.5 pF	ATC	800A1R5BT
C801	Capacitor, 1 μF	Digi-Key	490-4736-2-ND
C802, C804	Capacitor, 10 μF	Digi-Key	587-1818-2-ND
C803	Chip capacitor, 1000 pF	Digi-Key	PCC1772CT-ND
L101, L102	Inductor, 22 nH	Digi-Key	0805W220JT
R101, R102	Resistor, 1000 Ω	Digi-Key	P1.0KECT-ND
R103, R104	Resistor, 10 Ω	Digi-Key	P10GTR-ND
R801	Resistor, 100 Ω	Digi-Key	P100GTR-ND
R802	Resistor, 1300 Ω	Digi-Key	P1.3KGTR-ND
R803	Resistor, 10 Ω	Digi-Key	P101GTR-ND
R804	Resistor, 1200 Ω	Digi-Key	P1.2KGTR-ND
S1	Potentiometer	Digi-Key	3224W-202ECT-ND
S2	Transistor	Digi-Key	BCP56-ND, BCP56
S3	Voltage regulator	Digi-Key	LM780L05ACM-ND, 7805
C201	Capacitor, 0.8 pF	ATC	800A0R8BT
C202, C203	Capacitor, 100 μF	Digi-Key	PCE4442TR-ND
C206, C207, C208, C209	Capacitor, 4.7 μF	Digi-Key	490-1864-2-ND
C210, C211, C212, C213	Capacitor, 10 μF	Digi-Key	587-1818-2-ND

Pinout Diagram

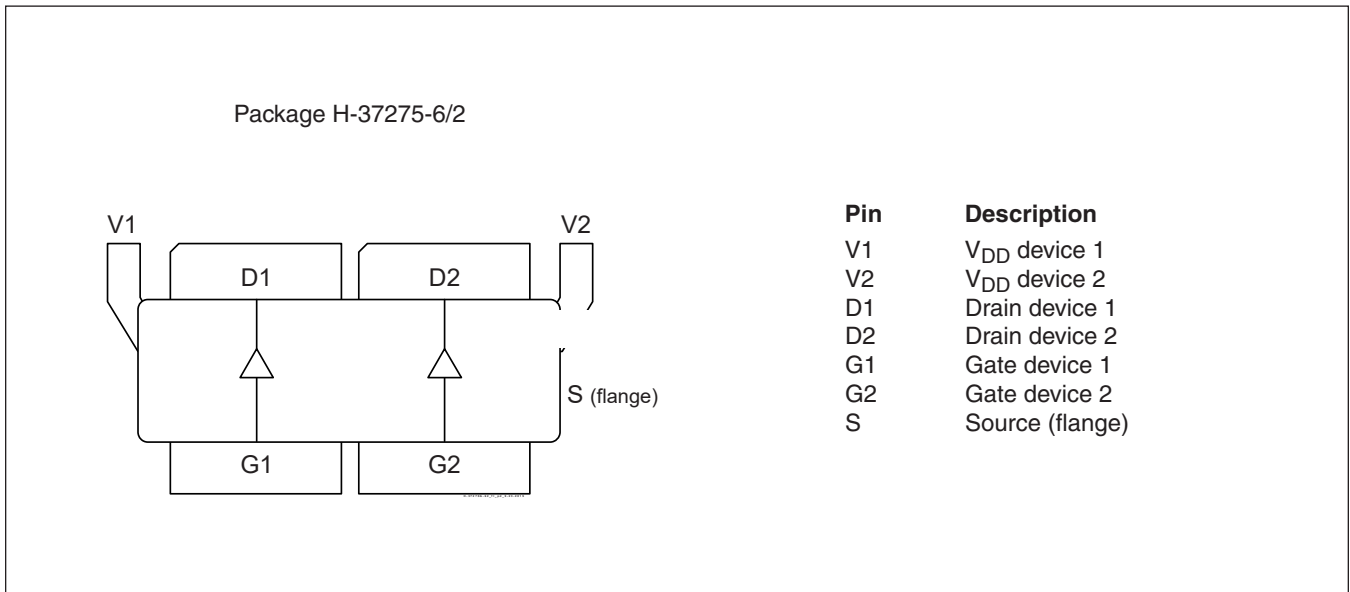

See next page for package outline specifications

Package Outline Specifications

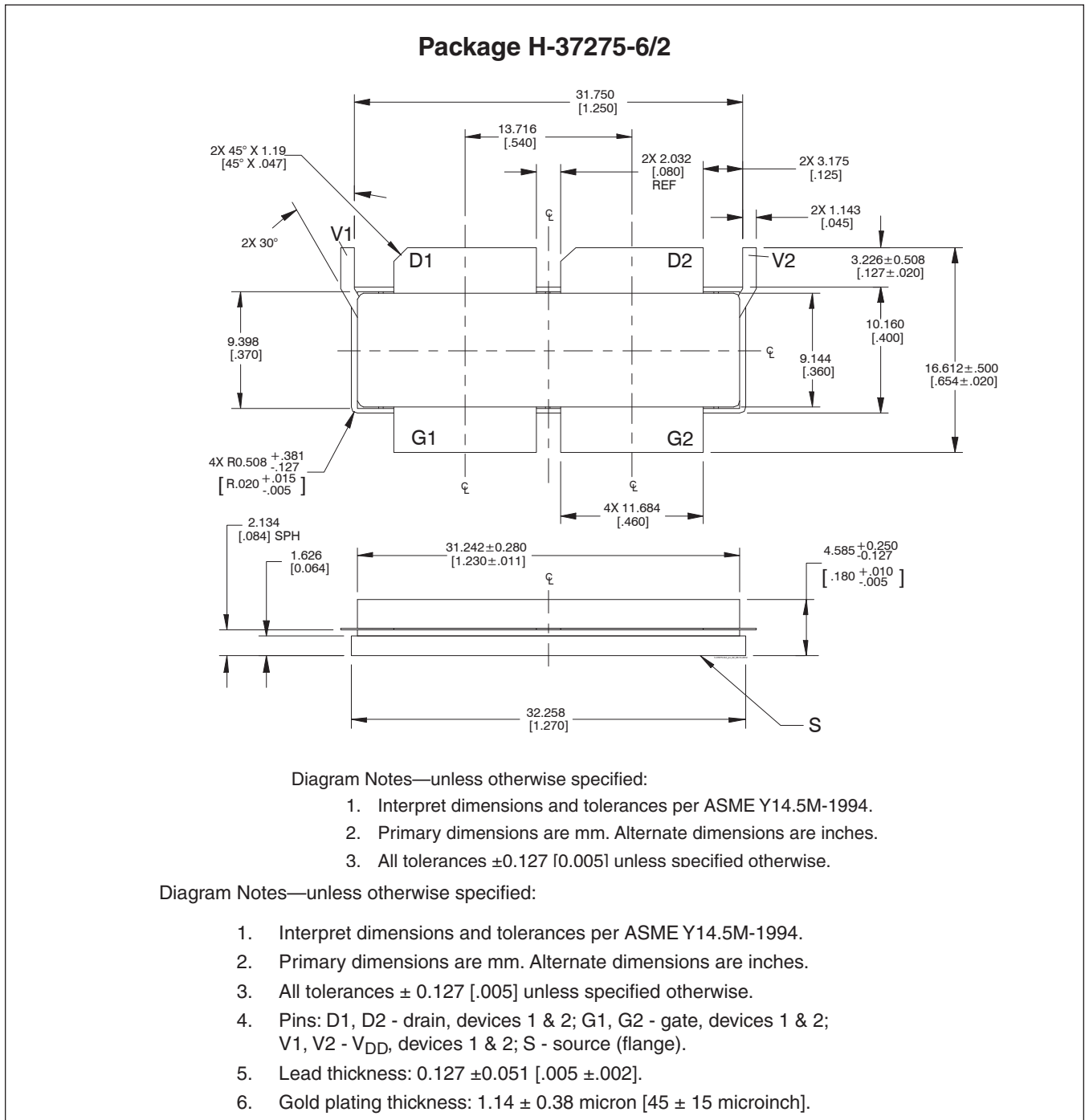

Revision History

Revision	Date	Data Sheet Type	Page	Subjects (major changes since last revision)
05.2	2016-06-04	Advance	3	Updated ordering information to include R0
06	2018-06-25	Production	All	Converted to Wolfspeed Data Sheet

For more information, please contact:

4600 Silicon Drive
 Durham, North Carolina, USA 27703
www.wolfspeed.com/RF

Sales Contact
RFSales@wolfspeed.com

RF Product Marketing Contact
RFMarketing@wolfspeed.com
 919.407.7816

Notes

Disclaimer

Specifications are subject to change without notice. Cree, Inc. believes the information contained within this data sheet to be accurate and reliable. However, no responsibility is assumed by Cree for any infringement of patents or other rights of third parties which may result from its use. No license is granted by implication or otherwise under any patent or patent rights of Cree. Cree makes no warranty, representation or guarantee regarding the suitability of its products for any particular purpose. "Typical" parameters are the average values expected by Cree in large quantities and are provided for information purposes only. These values can and do vary in different applications and actual performance can vary over time. All operating parameters should be validated by customer's technical experts for each application. Cree products are not designed, intended or authorized for use as components in applications intended for surgical implant into the body or to support or sustain life, in applications in which the failure of the Cree product could result in personal injury or death or in applications for planning, construction, maintenance or direct operation of a nuclear facility.