



WB2F 2D Code Scanner

User's Manual



Introduction

Attention

- IDEC Corporation holds all rights related to this manual. Unauthorized duplication, reproduction, sales, transfers, or leasing without the express consent of IDEC is prohibited.
- Information contained in this manual may be changed or updated without notice.
- Every effort has been made to ensure the accuracy of the information contained in this manual. However, if you do note any errors or inconsistencies please contact the dealer from which you purchased the product or an IDEC sales representative.

Applicable standards

This product is in compliance with the following standards:

- IEC/EN 61000-6-1 (2007)
- IEC 62471 (2006)
- IEC 61000-6-3 (2006)
- EN 61000-6-3 (2007)
- EN 55032 (2012) Class A
- EN 55024 (2010)
- UL 60950-1, 2nd Edition, 2011-12-19
- FCC Part 15 Subpart B Class A (Verification)
- CSA C22.2 No.60950-1
- ICES-003 Class A (self-declared)
- VCCI Class A (compliance confirmed)

FCC Regulations

This device complies with Part 15 of the FCC Rules. Operation is subject to the following two conditions:

- (1) This device may not cause harmful interference, and
- (2) this device must accept any interference received, including interference that may cause undesired operation.

NOTE: This equipment has been tested and found to comply with the limits for a Class A digital device, pursuant to Part 15 of the FCC Rules. These limits are designed to provide reasonable protection against harmful interference when the equipment is operated in a commercial environment. This equipment generates, uses and can radiate radio frequency energy and, if not installed and used in accordance with the instruction manual, may cause harmful interference to radio communications. Operation of this equipment in a residential area is likely to cause harmful interference in which case the user will be required to correct the interference at his own expense.

Canadian Department of Communications Compliance Statement

- CAN ICES-3(A) / NMB-3(A)

For further details on any of the above standards, please contact your sales agent directly.

Version Information

The following is the latest version information for the WB2F 2D Code Scanner. Prior to use, confirm the main application version of the firmware currently installed on the WB2F.

To confirm the firmware version currently installed on the WB2F, refer to "No. 46 Main Application Version Information" of [5.6 List of Control Commands] located on page 5-20.

Fixes and Improvements	Main application version
	WB2F-100S1B
Initial Release	A-001.000.00

General terms, abbreviations, and terminology used in this manual





The general terms, abbreviations, and terminology used in this manual are as follows.

Item	Definition
WB2F	An abbreviation for the WB2F-100S1B.
Communication interface	RS-232 Serial Communication Interface
Communication Unit	Refers to the Communication Unit WB9Z-CU100 available for purchase separately. The WB9Z-CU100 is a protocol converter that allows the WB2F to connect to RS-232/RS-422/Ethernet enabled devices.
Preventing Double Read Time	A parameter that specifies a time interval between reads to prevent the WB2F from reading the same code twice.
Number of characters	The sum of 1 byte codes either transmitted or received via the RS-232 interface.
AIM ID	An abbreviation for AIM Symbology Identifier
AI	An abbreviation for Application Identifier (standardized by GS1)
Pitch	Rotation of the symbol around the y-axis. Refer to  [5. 2. 3 Angle Characteristics] on page 5-5.
Skew	Rotation of the symbol around the x-axis. Refer to  [5. 2. 3 Angle Characteristics] on page 5-5.
Tilt	Rotation of the symbol around the z-axis. Refer to  [5. 2. 3 Angle Characteristics] on page 5-5.
Reading Timeout	A parameter that specifies the maximum time the WB2F will spend on reading a symbol.
Decode Timeout	A parameter that specifies the maximum time the WB2F will spend on a decode processing.
Receive Buffer	A storage area that temporarily stores received data.
Send buffer	A storage area that temporarily stores transmission data.
Quiet Zone	Blank region that surrounds the symbol
Control characters	ASCII codes 00H - 1FH and 7FH. In this manual, they are expressed using  . For details, refer to  [5. 9 ASCII Code Table] on page 5-22.
Prefix	Character data that is added to the beginning of output data and communication commands.
Suffix	Character data that is added to the end of output data and communication commands.
Output	Depending on the context, refers to the following: External Output, Communication Output, Status LED
Input	Depending on the context, refers to the following: READ/ENTER button, SELECT button, External Input, Communication Input
DPM	An abbreviation for Direct Part Marking. A process used to directly mark parts made out of materials such as metal and resin with product information such as 2D codes.
IDEC website	www.idec.com



Graphic Symbol Glossary

This manual uses the following graphic symbols to simplify explanations:

Notes

Graphic Symbol	Description
 Warning	Failure to operate the product in accordance with the information provided may result in severe personal injury or death.
 Caution	Failure to operate the product in accordance with the information provided may result in personal injury or damage to equipment.
	Notes information that should be carefully noted. Failure to operate the product in accordance with the information provided may affect the appearance and performance of the main unit as well as any peripheral devices.
	Denotes additional information that may prove useful for using a given function.

Status LED/Position Display LED

Graphic Symbol	Description
 (*)	Indicates that the LED is turned OFF
 (*)	Indicates that the LED is turned ON
 (*)	Indicates that the LED is Flashing

* In case of Status LED, color will change based on status (green/orange/red). In case of Position LED, a number denoting position (1/2/3/4) will be shown. In addition, the color of the graphic symbol will be drawn in accordance with the color of the LED.

SAFETY PRECAUTIONS

- Before installing and wiring this product, operating it, or performing maintenance and inspection, read this manual carefully and use the product correctly.
- The degree of possible danger that may occur if the product is mishandled is classified and denoted by "Warning" and "Caution" symbols. The meaning of each is as follows.



Warning

Failure to operate the product in accordance with the information provided may result in severe personal injury or death.



Caution

Failure to operate the product in accordance with the information provided may result in personal injury or damage to equipment.

Safety precautions



Warning

- This product was not designed for use in applications that require a high safety and reliability standard such as in medical equipment, equipment related to nuclear power, transportation equipment and devices related to rail, aviation and automotive products. Please do not use this product for these and/or similar applications.
- When using this product in applications that may impact human life, such as in the management of chemicals, only do so after taking the utmost care to include all redundancies, fail-safes and safety features into the design so as to ensure that human life is not impacted even if data is mistaken.
- Do not modify, disassemble, or attempt to repair this product. Doing so may result in electrical shock, damage, fire, malfunctions and other other serious accidents.
- When using this product in situations where it is not built into other equipment, do not use an integrated power supply. Otherwise there is a risk of fire or electric shock.
- Do not look directly at the scan window or direct the scanner towards other people's eyes while the LED light is on. There is a risk of causing damage to the eyes.
- This product has been designed for use in general electronic equipment only. It is not authorized for use in applications that require a high safety/reliability standard where malfunction or failure of the product may result in severe personal injury or death.
- Always turn the power supply off before performing any wiring, or mintenance work. Failure to do so may result in electric shock or malfunction.

⚠ Caution

- Do not connect the product to a power supply outside the rated power supply voltage range or to an AC power supply. Otherwise there is a risk of explosion or burnout.
- Mistakenly wiring the product may cause the internal circuit to be damaged. Wire the input and output circuits by referring to the connection examples in F P. 2-5 "2. 3. 1 Wiring the RS-232 type". This product is not equipped with a protection circuit for a reversed power supply connection, so there is a risk of damage when the power supply connection is reversed. Use extreme caution when connecting the power supply.
- Avoid parallel wiring of the product's wires in the same conduit or duct with high voltage lines or power lines (inverter power lines in particular) as this may cause malfunction or damage due to the effect of induction noise.
- If the wires are long and when there is a risk of being affected by power sources or solenoids, independently wire the product as a general rule.
- Avoid installing or using the product in the following locations as there is a risk of malfunction or damage.
 - Near induction equipment or heat sources
 - Locations with many vibrations or shocks
 - Dusty and dirty locations
 - In an atmosphere with hazardous gases such as sulfidizing gas
 - Locations in direct contact with water, oils, or chemicals
 - Outdoors
- This product is not an explosion-proof product. Confirm that explosion-proof capabilities are not required when installing the product.

Precautions for Use

⚠ Caution

- Use the product in the environment listed in the catalog and manual. If this product is used in locations with high temperatures, high humidity, condensation, corrosive gas, or excessive vibration/shock, there is a risk of electric shock, fire, and malfunction.
- The usage environment pollution degree for this product is "pollution degree 2". Use the product in a pollution degree 2 environment.
(Based on the IEC 60664-1 standard)



- The power reset time is under 5s. Perform operations 5s after turning the power on.
- When the load and the unit are connected to different power supplies, always turn on the unit's power supply first.
- Install the product so that the scan window is not directly exposed to sunlight or fluorescent light.
- The non-volatile memory equipped on the WB2F can be overwritten 100,000 times.

Cleaning

● Cleaning the Scan Window

Keep the scan window free of dust, dirt, moisture and scratches as it will negatively affect scanning performance.

Inspect the scan window periodically and remove any dirt or dust that may have accumulated.

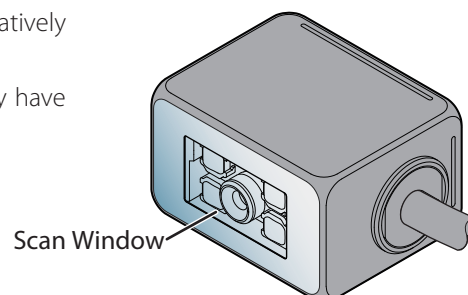

Cleaning methods

- To clean the scan window, blow the dust/dirt away with an airbrush, and then gently wipe it off with a cotton swab or a similarly soft object.
- If moisture has collected on the scan window, wipe with a soft cloth.
- Always turn the WB2F power off before cleaning the product.



Do not use organic solvents such as alcohol, thinner or benzene as they may affect the optics of the WB2F.

● Cleaning the unit

- Wipe any dust or dirt off of the WB2F with a soft, dry cloth.
- If the product is excessively dirty, wipe the surface with a soft cloth that has been soaked in a dilute neutral detergent solution and thoroughly wrung out. Dry with a soft dry cloth.



Do not use organic solvents such as alcohol, thinner, or benzene as this may alter the housing or strip the paint.

Related manuals

Manuals related to the WB2F are as follows. Refer to them together with this manual.

All related manuals are available for download from our website.

Type	Manual name	Details
B-1952	WB2F 2D Code Scanner User's Manual (this manual)	Gives an overview of the functions and capabilities of the WB2F, and instructions on its use.
B-1945	Instruction Sheet: WB2F 2D Code Scanner	Included with the product.
B-1946	Instruction Sheet: WB9Z-CU100 Communication Unit	Included with the product.
B-1963	WB9Z-CU100 Communication Unit User's Manual	Gives an overview of the functions and capabilities of the communication unit as well as instructions on its use.

Contents

Introduction i

Attention	i
Applicable standards	i
Version Information	ii
General terms, abbreviations, and terminology used in this manual	iii
Graphic Symbol Glossary	iv
Notes	iv
Status LED/Position Display LED	iv
SAFETY PRECAUTIONS	v
Safety precautions	v
Precautions for Use	vi
Cleaning	vii
Related manuals	viii

Contents ix

1 Overview 1-1

1.1	Checking the packaged product and the product configuration	1-1
1.2	Part names and functions	1-2
1.3	System configuration	1-3
1.4	Accessories and Peripheral Devices	1-5

2 Installation & wiring 2-1

2.1	Installation precautions	2-1
2.2	Mounting methods	2-3
2.2.1	WB2F mounting methods	2-3
2.2.2	Setup symbol position	2-4
2.3	Wiring	2-5
2.3.1	Wiring Instructions: Connecting the WB2F to the Communication Unit	2-5
2.3.2	Wiring Instructions: Setting up the WB2F without the Communication Unit	2-12
2.3.3	Connecting the USB Cable	2-15

3 Operational Check 3-1

3.1	Performing an Operational Check using a PC	3-1
3.1.1	Necessary operating environment of the PC	3-1
3.1.2	Installing the Device Driver	3-1
3.1.3	Connecting to a PC	3-2
3.2	Confirming a Successful Read	3-3
3.3	Symbol Read Data Confirmation	3-4

4 Function 4-1

4.1	Overview	4-1
4.1.1	Operation mode	4-1
4.1.2	Operation mode switching operation and status	4-3
4.2	Slave Mode	4-4
4.2.1	Switching operation to slave mode	4-4
4.2.2	Symbol reading	4-5
4.2.3	Output data additional information	4-15
4.2.4	Output data editing	4-20
4.2.5	Verification	4-22
4.2.6	Command alias	4-26
4.2.7	Communication command	4-28
4.2.8	Parameter Changeover	4-31
4.2.9	Image Capture	4-34
4.2.10	Image Filter	4-37
4.2.11	I/O	4-40
4.3	Setup support mode	4-41
4.3.1	Switching operation to setup support mode	4-41
4.3.2	Reading Success Rate Measurement	4-44
4.3.3	Decoding Processing Time Measurement	4-45
4.3.4	Symbol Position Measurement	4-46
4.3.5	Autotuning	4-48
4.4	Maintenance mode	4-50
4.4.1	Switching operation to maintenance mode	4-50
4.4.2	Maintenance support	4-52
4.4.3	Firmware updating	4-52
4.5	Master Mode	4-53
4.5.1	Switching to Master Mode	4-53
4.5.2	Connecting to a PLC	4-53

4.6	Configuration Item Table.....	4-54
4.7	Communication Unit	4-93
4.7.1	Overview.....	4-93
4.7.2	Names and functions of its parts	4-94

5 Appendix

5-1

5.1	Product specifications.....	5-1
5.2	Field of view/characteristics.....	5-3
5.2.1	Reading Range.....	5-3
5.2.2	Field of View.....	5-4
5.2.3	Angle Characteristics.....	5-5
5.3	Dimensional outline drawings	5-7
5.4	Troubleshooting.....	5-9
5.5	Timing Chart	5-10
5.5.1	Scan Operation Timing Chart.....	5-10
5.5.2	External Output Timing Chart.....	5-11
5.6	List of Control Commands	5-13
5.7	Control Commands (Details).....	5-17
5.8	Check digit calculation method.....	5-21
5.9	ASCII Code Table.....	5-22
5.10	AIM symbology ID table	5-24
5.11	GS1-128 Application Identifier.....	5-26
5.12	Initialization Barcode	5-27
5.13	Sample labels.....	5-28
5.14	Installing the USB driver	5-31
5.15	Setting check digit.....	5-32

Index

A-1

Revision history

A-3

1 Overview

This chapter describes the product configuration of the WB2F, the names and functions of its parts, and the basic system configuration during operation.

1.1 Checking the packaged product and the product configuration

The WB2F is packaged with the following items:

Before using the WB2F, check that the unit and accessories are present and that they have suffered no damage.

Unit: 1

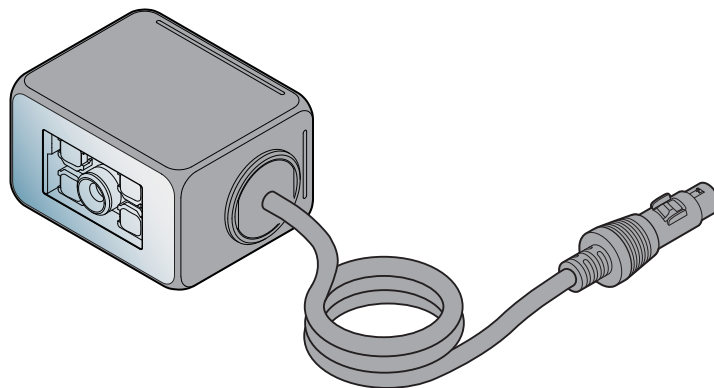

Mounting screws (M3): 2

the WB2F is shipped with the mounting screws attached

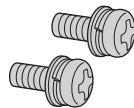

Mounting Bracket: 1

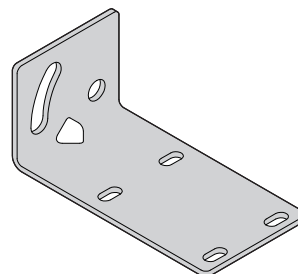

Instruction Manual: 1

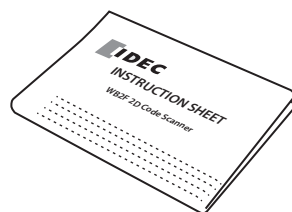

1.2 Part names and functions

This section describes the names and functions of WB2F parts.

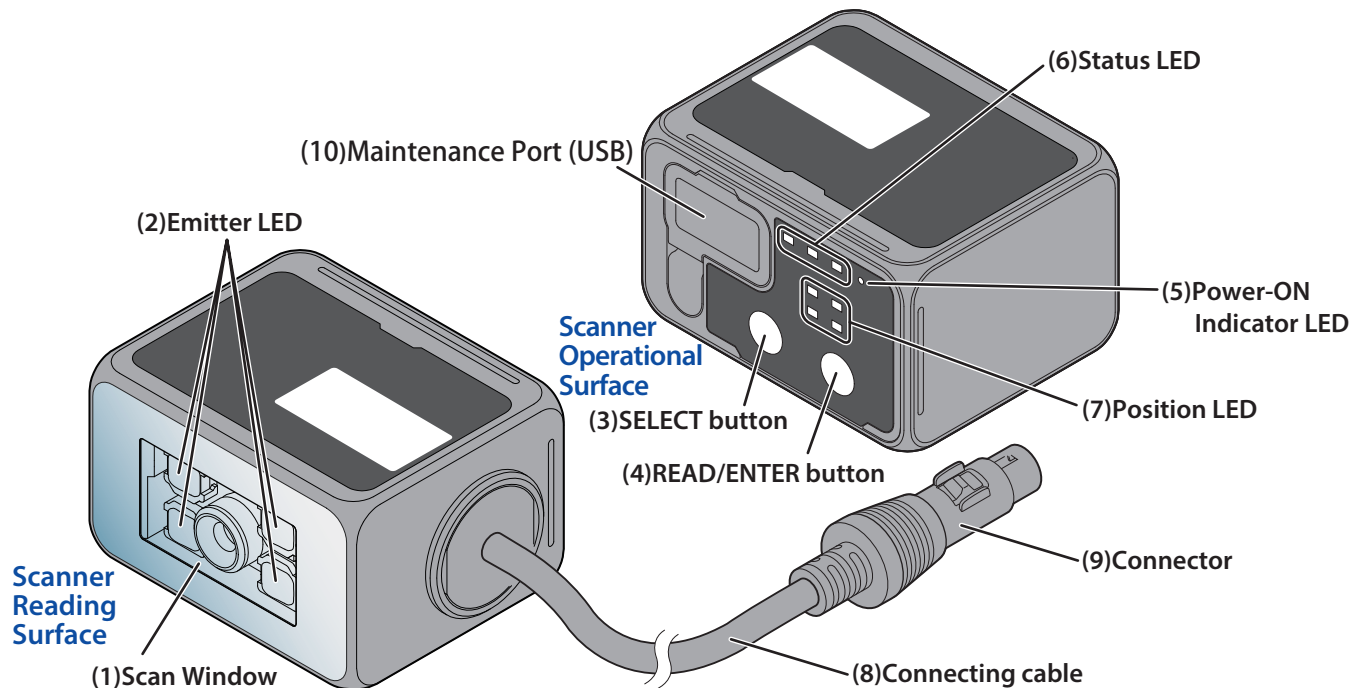

No.	Description	Function
(1)	Scan Window	The window protects the optical components of the WB2F from dust, debris and moisture.
(2)	Emitter LED	Lights up during scan operation (based on settings, this is not the only time it will light up) Lighting modes, the number of LEDs that light up etc. can be altered via settings.
(3)	SELECT button	Used to select various functions
(4)	READ/ENTER button	Used to confirm various functions that have been selected
(5)	Power-ON Indicator LED	Green LED will light up when the WB2F's power is on
(6)	Status LED	The Status LED indicates the operating status of the unit. (Green): Turns on when reading has succeeded and the read image is matched on comparison. (Orange) : Turns on during a reading operation. (Red): Turns on when reading fails and the read image is not matched on comparison. This operation may differ due to the settings. The status of the Status LEDs also changes due to the unit's operating status.
(7)	Position LED	Displays the Position of the symbol. (1) - (4): The position of the symbol placed in the WB2Fs FOV will light up on the LED display.
(8)	Connecting cable	Cable length: 2 m
(9)	Connector	DIN Connector (manufactured by Hosiden, TCP9386, Male) used to provide power to the WB2F, or connect to the communication unit.
(10)	Maintenance Port (USB)	Port that utilizes the USB interface to perform various maintenance operations (USB 2.0, Mini-B). If connecting to a host device, use its accessory or any commercially available USB cable.

1.3 System configuration

The typical system configuration when operating the WB2F is as follows.

With the Communication Unit

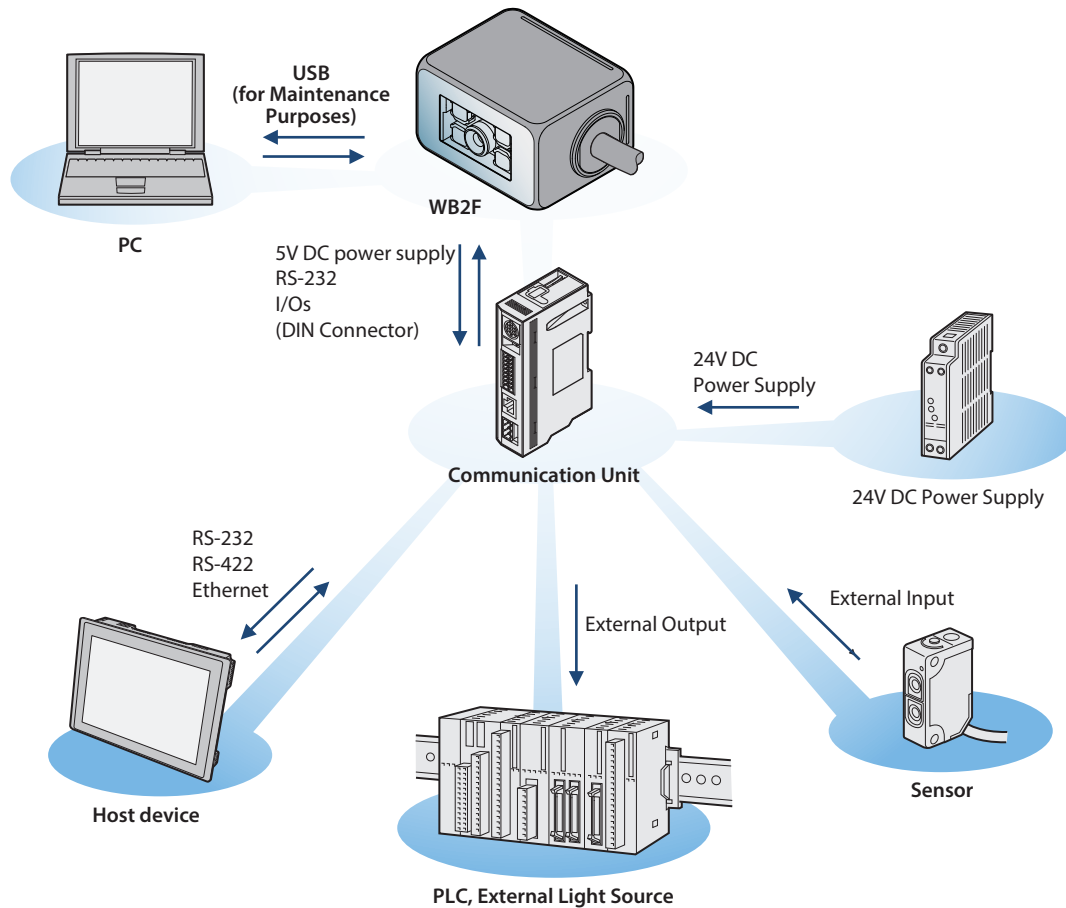

The device driver must be installed prior to connecting the WB2F to a PC via USB. Refer to [\[5. 14 Installing the USB driver\]](#) on page 5-31 for installation instructions.

Without the Communication Unit

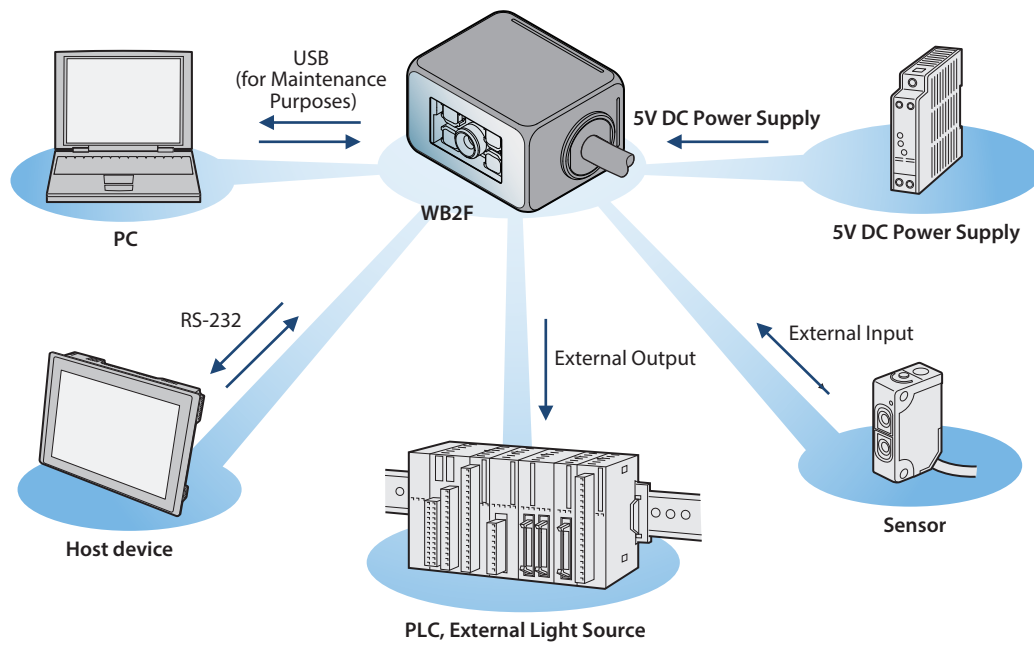

The device driver must be installed prior to connecting the WB2F to a PC via USB. Refer to [\[5. 14 Installing the USB driver\]](#) on page 5-31 for installation instructions.

1.4 Accessories and Peripheral Devices

The WB2F's accessories and peripheral devices are as follows:

● Accessories

USB Maintenance Cable
HG9Z-XCM42

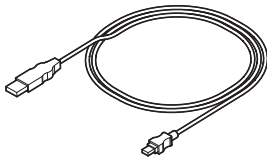

● Peripheral Devices

WB2F compatible communication unit
WB9Z-CU100

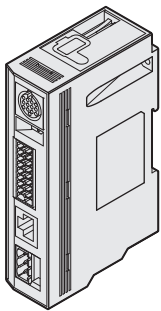

2 Installation & wiring

This chapter describes WB2F installation locations, mounting methods, and wiring the WB2F to peripheral devices.

2.1 Installation precautions

- Install the unit so that ambient light such as sunlight, fluorescent light, and photoelectric switches does not enter the scan window.
Otherwise the unit may not be able to read symbols or it may erroneously read them.

Example Take measures to block ambient light or to change the position of photoelectric switches.

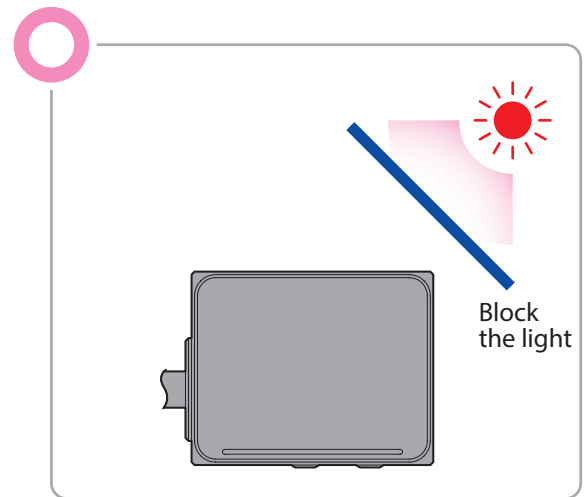
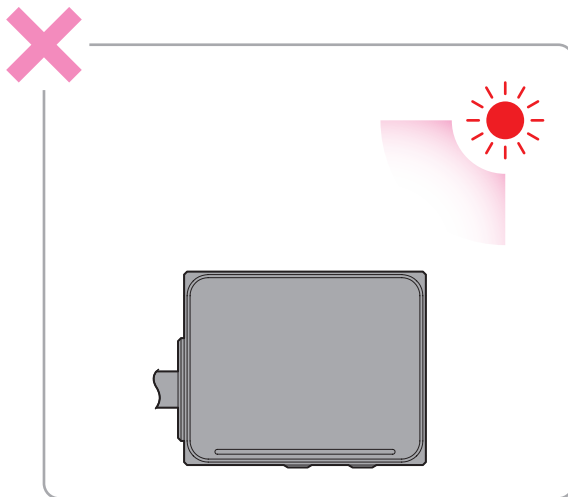

- Do not install a reflective body (metal or mirror) along the light receiving axis.
Otherwise the unit may not be able to read symbols or it may erroneously read them.

Example Tape over any mirrored/reflective surfaces with black tape to prevent the reflection of light.

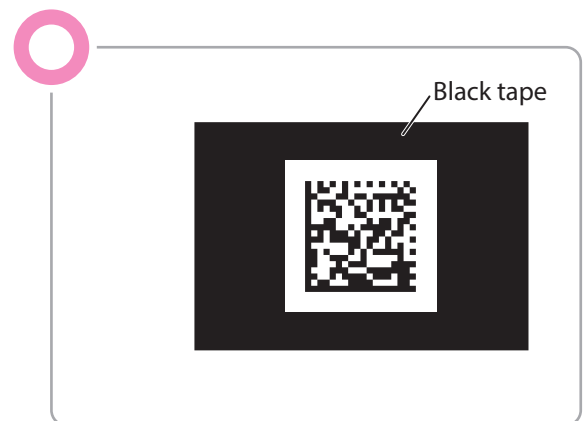
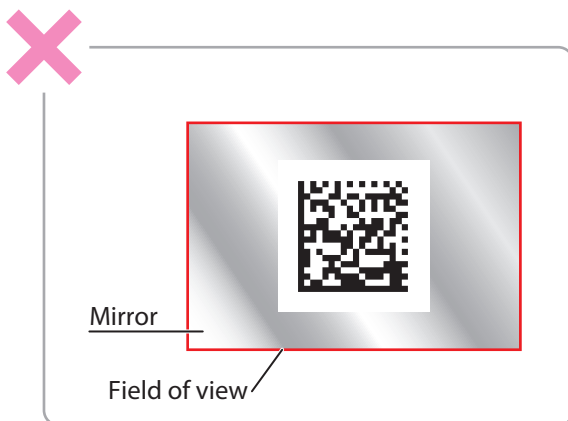

- When installing WB2F units in a series, install them so the emitted LED light does not overlap (so they do not interfere with each other).

Otherwise the unit may not be able to read symbols or it may erroneously read them.

Example Install the WB2F units by increasing the spacing between them.

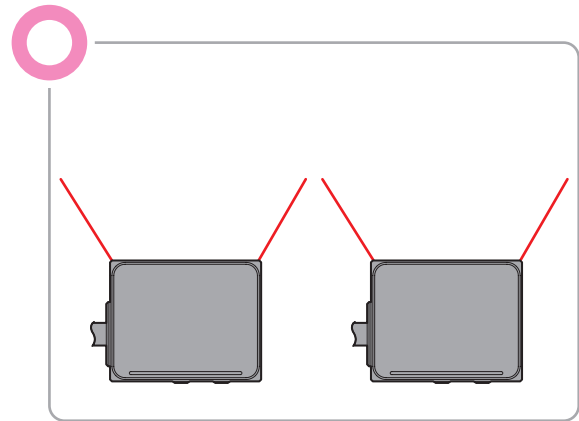
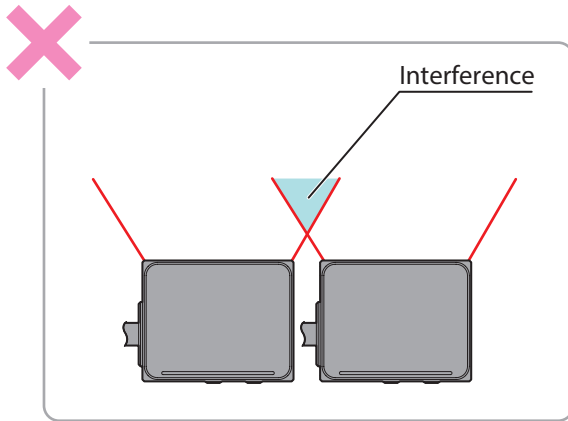

2.2 Mounting methods

2.2.1 WB2F mounting methods

1 Double check the dimensions of the mounting hole and drill a hole in the mounting board
For the dimensions of the mounting hole, refer to  [5.3 Dimensional outline drawings] on page 5-7.

2 If you use the brackets provided, use the two mounting screws (also provided) to secure the bracket to the WB2F before you secure the bracket to the mounting board.
If you do not use the brackets provided, use the two mounting screws to secure the WB2F to the mounting board.

The tightening torque for the product mounting screws is 0.4 to 0.5 N·m.

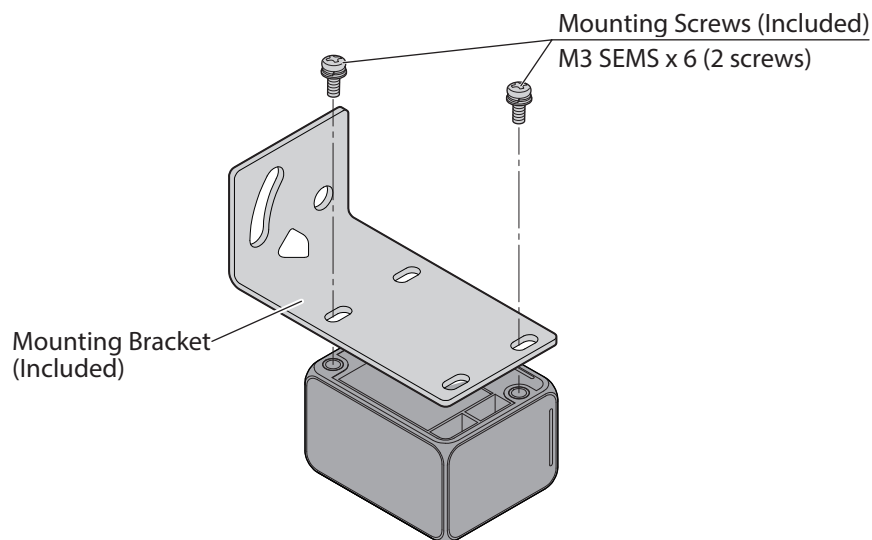

- Instead, use two M3 screws with an effective thread length of 3 to 5 mm and secure the WB2F to the plate.
- If you use a bracket other than the one that was included, make sure that the dimensions of the mounting holes is at most $\Phi 3.4\text{mm}$
- When using the WB2F, remove the protective film on the scan window.



- If you attach to a plate that is thicker than 2.3 mm, do not use the included mounting screws.
- If, during installation, the WB2F is exposed to excessive force (e.g. the mounting screws are tightened excessively, the product is hit with a hammer, the base of the cable is exposed to excessive stress (pulled strongly, bent etc.)), it could undermine the IP65 protective structure of the WB2F.

2.2.2 Setup symbol position

Install the unit so that symbol skew θ is in the range of $+15^\circ \leq \theta \leq +60^\circ$ and $-60^\circ \leq \theta \leq -15^\circ$.

For the reading range, refer to [\[5.2.1 Reading Range\]](#) on page 5-3. For other angular characteristics, refer to [\[5.2.3 Angle Characteristics\]](#) on page 5-5. For detailed dimensions, refer to [\[5.3 Dimensional outline drawings\]](#) on page 5-7.

e.g. Changing Emitter LED pattern to 4

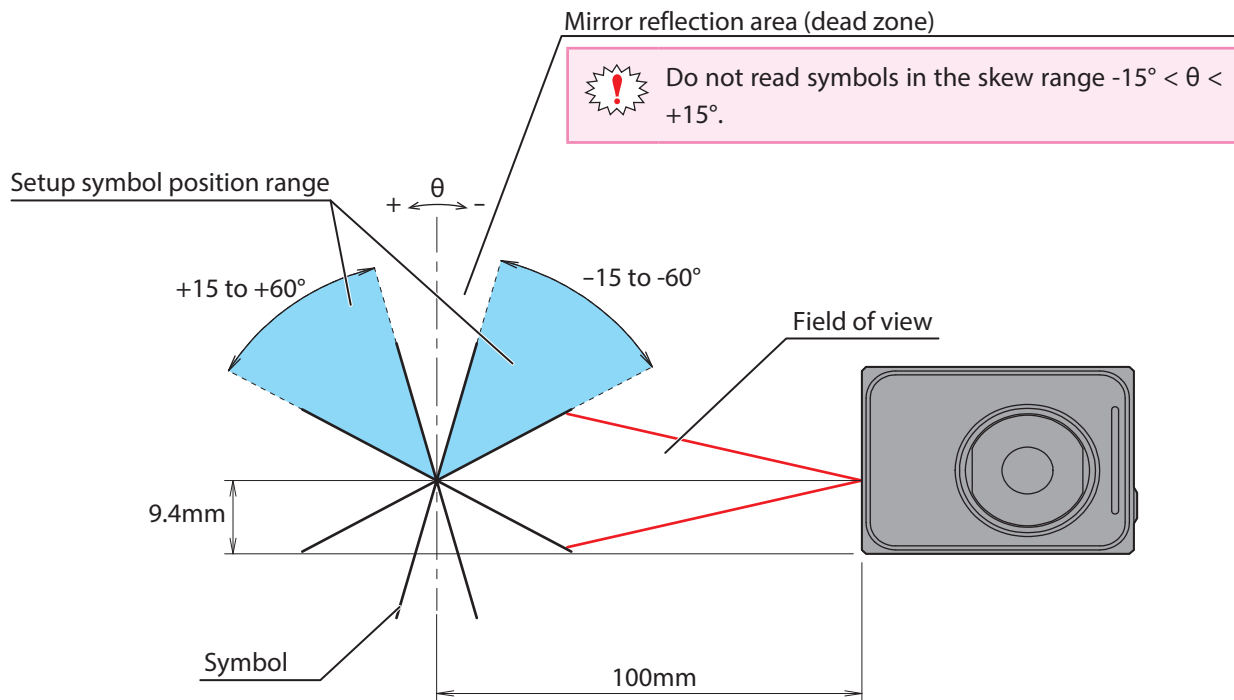

- Skew in a range of $-15^\circ < \theta < +15^\circ$ is in the mirror reflection area (dead zone), so reading performance may drastically decrease in ways such as the unit not being able to read or misreading symbols
- The mirror reflection area (dead zone) will differ based on the emitter LED's lighting pattern.



To adjust the WB2F's position while confirming the symbol's read success rate, follow the steps described in [\[4.3 Setup support mode\]](#) on page 4-41.

2.3 Wiring

2.3.1 Wiring Instructions: Connecting the WB2F to the Communication Unit

For an overview of the communication unit refer to [\[4.7 Communication Unit\]](#) on page 4-93. For dimensions of the communication unit refer to [\[5.3 Dimensional outline drawings\]](#) on page 5-7.

● Connecting to the WB2F

The WB2F and the Communication Unit's connection diagram is the following:

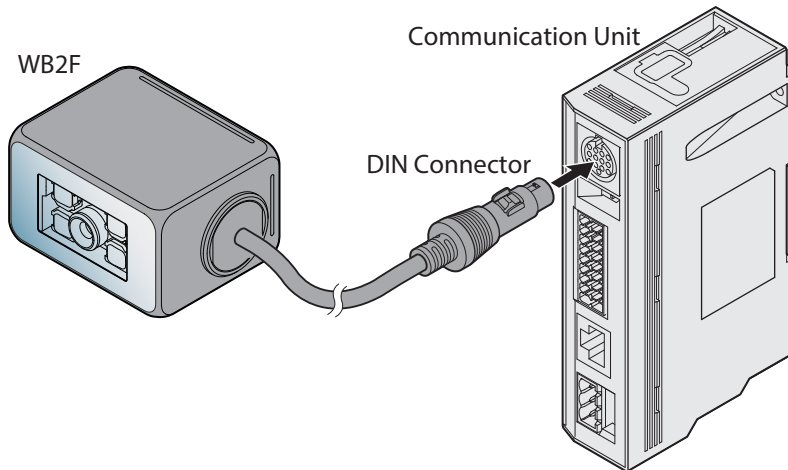

● Connector Pin Assignment

Communication Unit's connector pin assignment is as follows:

Scanner Port

DIN Connector

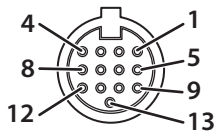

Pin Number	Description	Function
1	Out_0	Output from the WB2F (NPN Open Collector)
2	Out_1	
3	Out_2	
4	Out_3	
5	5VDC	WB2F Power Supply (+V)
6	S_RD	WB2F Received Data (RS-232)
7	In_0	Input to the WB2F
8	In_1	
9	0V	WB2F Power Supply (-V, SG Shared)
10	S_SD	WB2F Transmission Data (RS-232)
11	S_RS	RS-232 Control Signal
12	S_CS	
13	0V	WB2F Power Supply (-V, SG Shared)

Input/Output/RS-232/RS-422 port

Connector for Input/Output/RS-232/RS-422 port

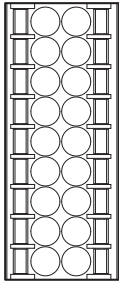

SDA	•	•	OUT_COM
SDB	•	•	OUT_0
RDA	•	•	OUT_1
RDB	•	•	OUT_2
SG	•	•	OUT_3
RD	•	•	IN_COM
SD	•	•	IN_0
CS	•	•	IN_1
RS	•	•	NC

Description	Function	Description	Function
SDA	RS-422 Connection with a Host Device	OUT_COM	Output from the WB2F
SDB		OUT_0	
RDA		OUT_1	
RDB		OUT_2	
SG	RS232/RS422 Connection with Host Device	OUT_3	
RD	RS-232 Connection with a Host Device	IN_COM	Input to the WB2F
SD		IN_0	
CS		IN_1	
RS		NC	Unused

External Power Port

Connector for an External Power Port

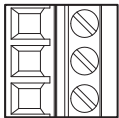

DC24V	•
0V	•
FE	•

Description	Function
DC24V	Power Supply (+V) for Communication Unit
0V	Power Supply (-V) for Communication Unit
FE	Functional Ground for Communication Unit

● Connecting the Power Supply

There are two methods for connecting the power supply

- Using an external power supply
- Using PoE (Power over Ethernet)

Using an External Power Supply

Connect the 24V DC power supply adaptor to the communication unit's external power supply port.

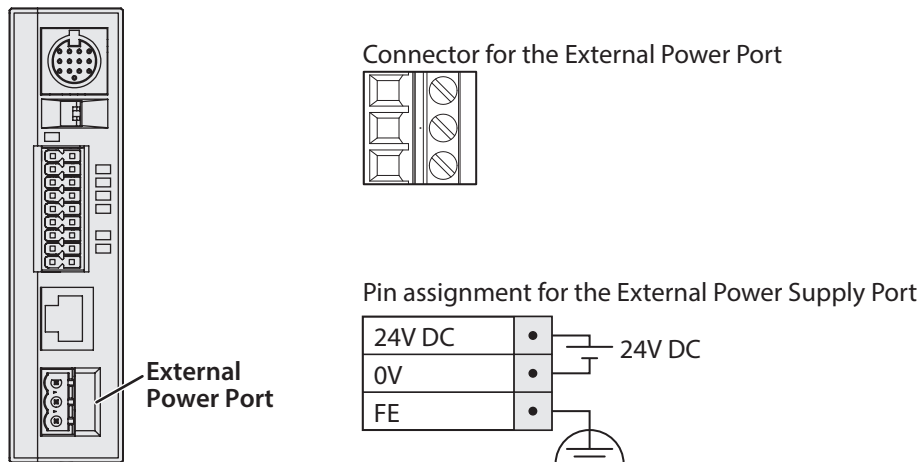

⚠ Caution

- Do not reverse the power supply connections under any circumstances. Doing so may result in damage.
- Use the product within the rated power supply voltage range. Otherwise there is a risk of explosion or burnout.



- Always turn off the WB2F's power supply before wiring the product.
- Do not simultaneously use an external power supply and PoE.
- Use an AWG12 to 24 Cable for wiring.



- If using as a UL certified product, the external power source must be at most 24V DC, 8A, 100VA Limited Power Source or Class 2 Power Source.
- A normal type fuse rated 2.5A, 60V DC is built into the product.

Using PoE

Connect the PoE to the Communication Unit's Ethernet Port. Even if using PoE, ground the FE terminal of the external power supply's port connector.

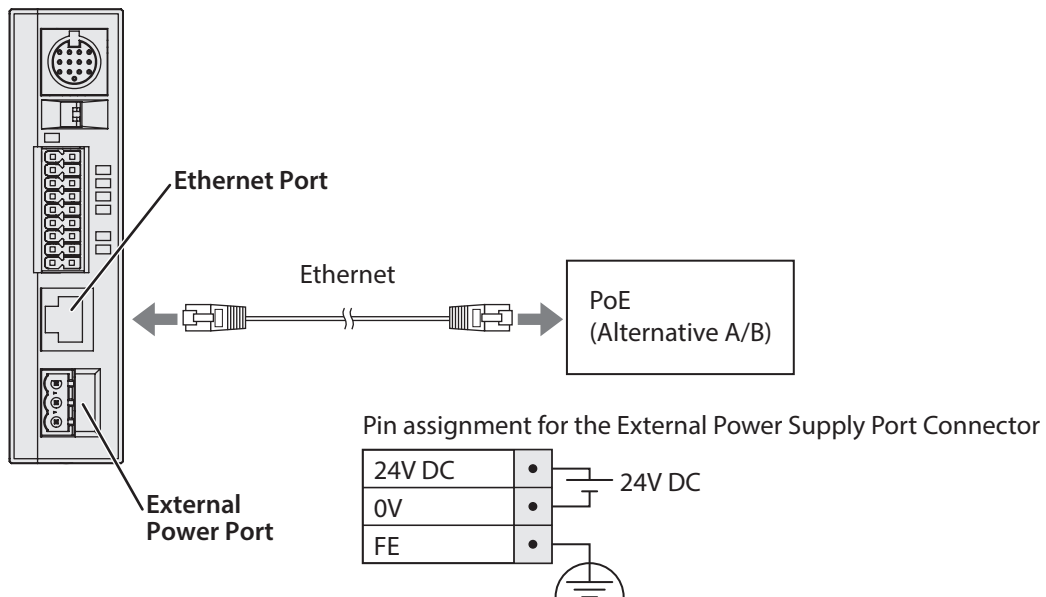

- Turn the communication unit's power to OFF prior to performing any wiring work.
- Do not simultaneously use an external power supply and PoE.



PoE is treated as Class 0.

● RS-232 wiring

If connecting the WB2F to a host device such as programmable display or a computer using RS-232, do so according to the following wire instructions:

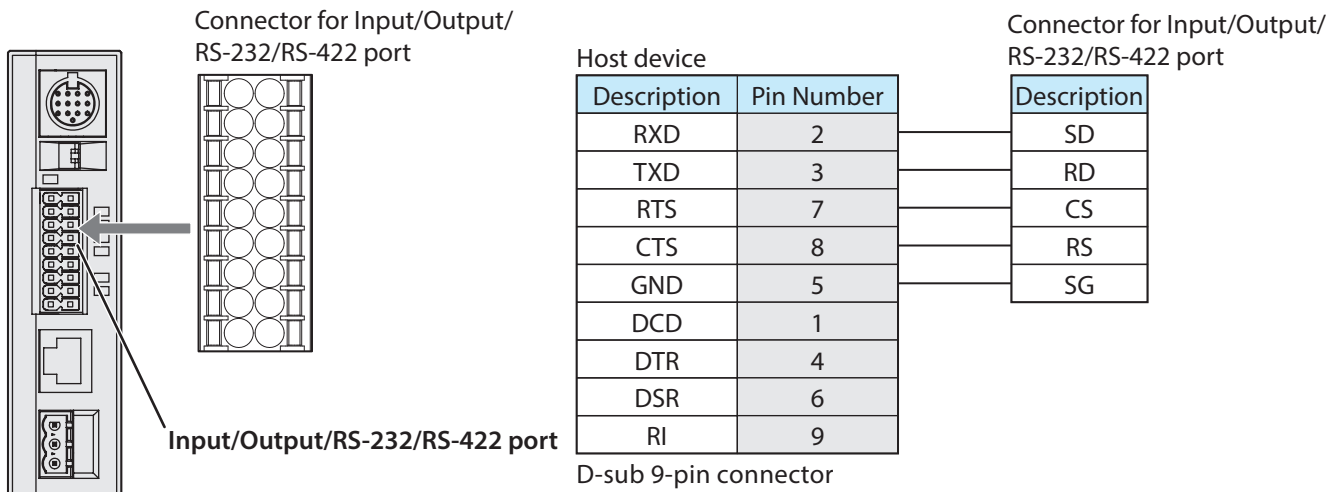

- Ethernet/RS-232/RS-422 cannot simultaneously use more than two types of communication.
- Use an AWG16 to 24 Cable for wiring.

● RS-422 wiring

If connecting the WB2F to a host device such as programmable display or a computer using RS-422, do so according to the following wire instructions:

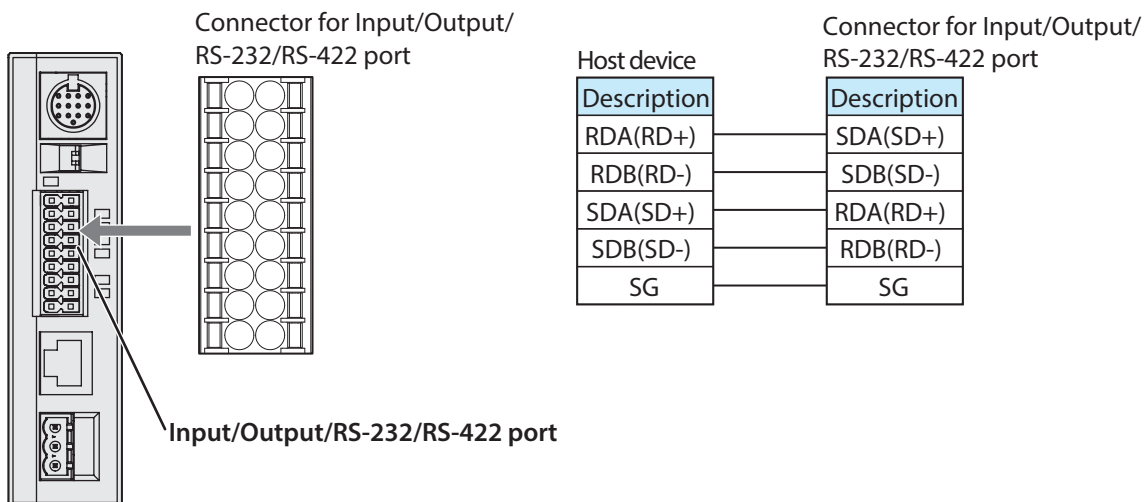

- Ethernet/RS-232/RS-422 cannot simultaneously use more than two types of communication.
- Do not use a cable that is longer than 500m.
- If using a cable that is longer than 30m, use a shielded cable and connect the shield to the FE terminal. Wire the shield with sufficient consideration of the environment.
- Use an AWG16 to 24 Cable for wiring.

● Wiring for Ethernet Communication

If connecting the WB2F to a host device such as programmable display or a computer using an ethernet connection, do so according to the following wire instructions:

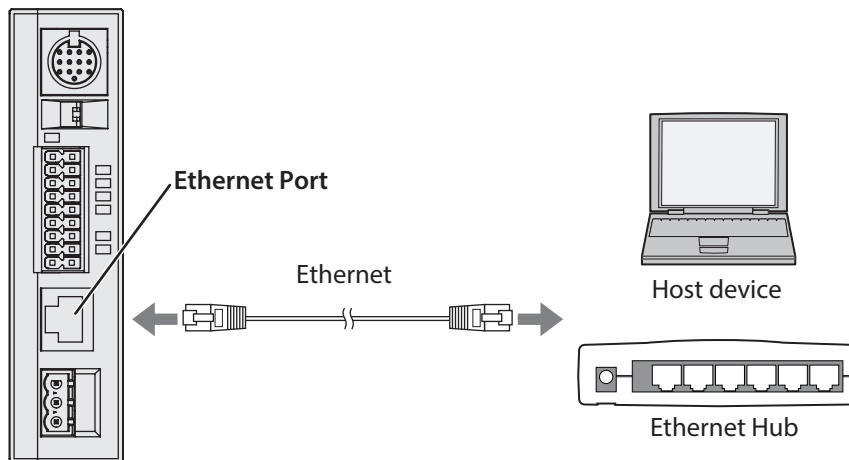

- Ethernet/RS-232/RS-422 cannot use more than two types of communication at once.
- Connect the PoE to the Communication Unit's Ethernet Port. Even if using PoE, ground the FE terminal of the external power supply's port connector.
- Use a cable rated over category 5.
- Do not use a cable that is longer than 100m.
- If using a cable that is longer than 30m use a shielded cable.

● Wiring for External Input

External Input is a trigger input used to turn Read Request ON/OFF.

External Input will operate given the following voltage input (VIL:0-5V, VIH: 15-28.8V).

Refer to the following example prior to wiring the WB2F.

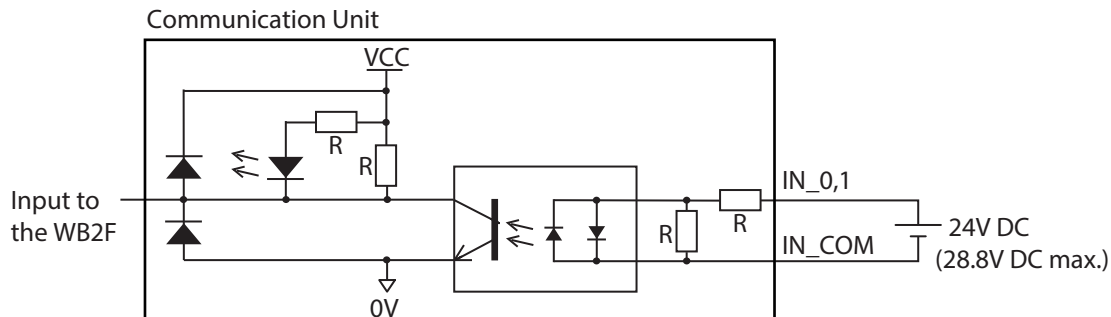

Caution

Miswiring may cause damage to internal circuitry.



Use an AWG16 to 24 Cable for wiring.

● Wiring for External Output

External Output is used to determine read success/read failure during read operations.

Refer to the following example prior to wiring the WB2F.

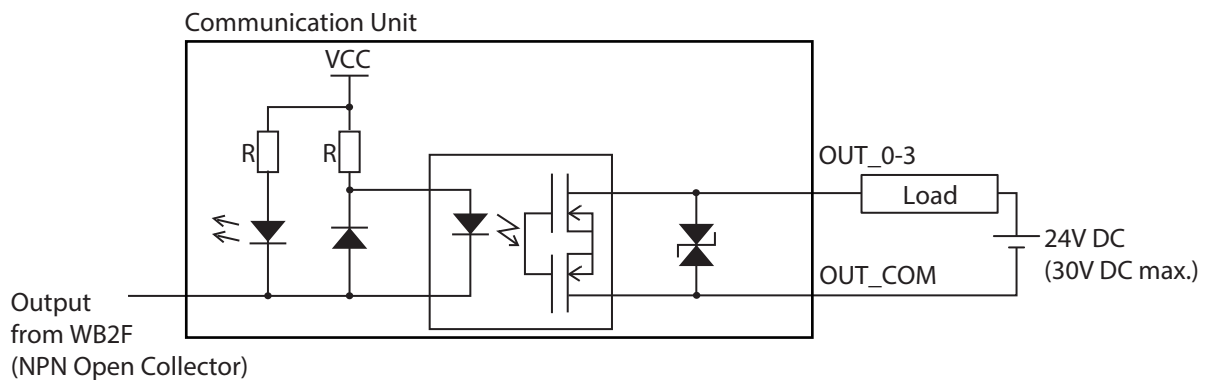

Caution

Miswiring may cause damage to internal circuitry.



- If the Load and the WB2F are connected to separate power supplies, make sure that you turn the WB2F's power on first.
- Use an AWG16 to 24 Cable for wiring.

2.3.2 Wiring Instructions: Setting up the WB2F without the Communication Unit

● Connector Pin Assignment

The WB2F's connector pin assignment is as follows.

DIN Connector

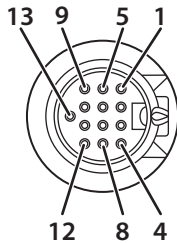

Pin Number	Wire color		Discription	Function
1	Gray	Red Dot	OUT0	External Output 0
2	Gray	Black Dot	OUT1	External Output 1
3	White	Red Dot	OUT2	External Output 2
4	White	Black Dot	OUT3	External Output 3
5	Orange	Red Dot2	+5V	Power Supply +
6	Pink	Black Dot	TXD	RS-232 Transmission Data
7	Orange	Red Dot	IN0	External Input 0
8	Orange	Black Dot	IN1	External Input 1
9	Orange	Black Dot2	0V	Power Supply (- SG Shared)
10	Pink	Red Dot	RXD	RS-232 Received Data
11	Yellow	Red Dot	CTS	RS-232 Control Signal
12	Yellow	Black Dot	RTS	RS-232 Control Signal
13	-	-	NC	No connection



Either the DIN Connector Shell or the Cable Shield is not connected to the main body
Make the determination to connect to FE or SG depending on the level of surrounding noise

● Wiring the power supply

Connect pin number 5 (+ 5V) to the 5V DC power supply + side and pin number 9 (0 V) to the - side. Read the following notes carefully and refer to the wiring example below before attempting to wire the power supply.

WB2F

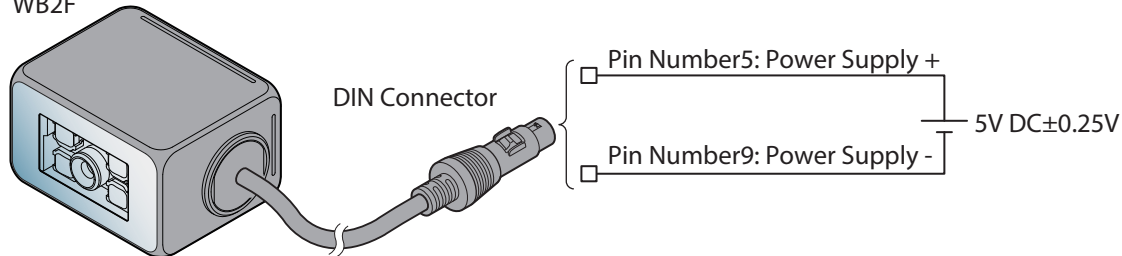

⚠ Caution

- Do not reverse the power supply connections under any circumstances. Doing so may result in damage.
- Use the product within the rated power supply voltage range. Otherwise there is a risk of explosion or burnout.
- When using this product in situations where it is not built into other equipment, do not use an integrated power supply. Otherwise there is a risk of fire or electric shock.
- Avoid parallel wiring of the product's wires in the same conduit or duct with high voltage lines or power lines (inverter power lines in particular) as this may cause malfunction or damage due to the effect of induction noise.



- The power reset time is under 5s. Perform operations 5s after turning the power on.
- Always turn off the WB2F's power supply before wiring the product.
- If the wires are long and when there is a risk of being affected by power sources or solenoids, independently wire the product as a general rule.
- If you elongate the cable via a DIN connector, be careful of short circuit between adjacent terminals and consider the subsequent voltage drop of the power supply and use a cable thicker diameter than AWG28. If the entire cable exceeds a length of 2.8m, there is a possibility that it will adversely affect noise immunity. Do so only after thoroughly confirming that the WB2F's performance is not impacted.

● RS-232 wiring

When connecting the unit to a host device such as an operator interface or a computer via RS-232, wire it referring to the following example.

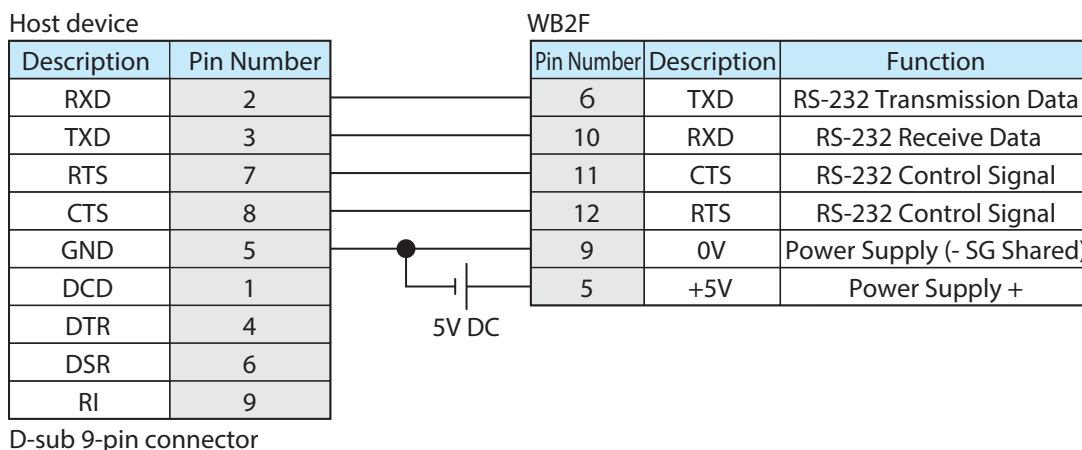

● Wiring for External Input

External Input is a trigger input used to turn Read Request ON/OFF.

The external trigger input operates as a non-voltage input or a voltage input (VIL: 1.0V, VIH: 4.0 V-VCC).

Refer to the following example prior to wiring the WB2F.

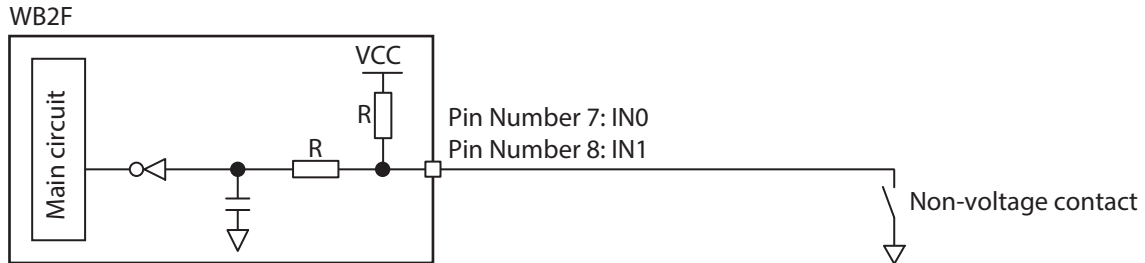

Caution

Mistakenly wiring the product may cause the internal circuit to be damaged.

● Wiring for External Output

External Output is used to determine read success/read failure during read operations.

Refer to the following example prior to wiring the WB2F.

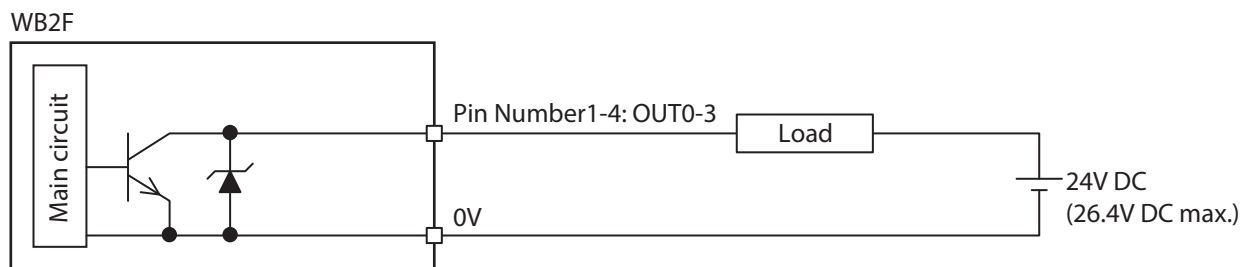

Caution

Mistakenly wiring the product may cause the internal circuit to be damaged.



When the load and the unit are connected to different power supplies, always turn on the unit's power supply first.

2.3.3 Connecting the USB Cable

● USB connector pin assignment

USB connector is Mini-B (Female) type.

Pin Number	Signal name	Function
1	VBUS	bus power
2	D-	Data-
3	D+	Data+
4	NC	No connection
5	GND	Ground

USB Connector (Mini-B)

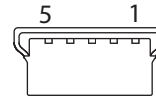

The WB2F cannot be powered via the USB connector.

● Connecting the USB connector

When connecting the unit to a host device, firmly insert the USB connector straight into the USB port on the host device in the correct orientation.

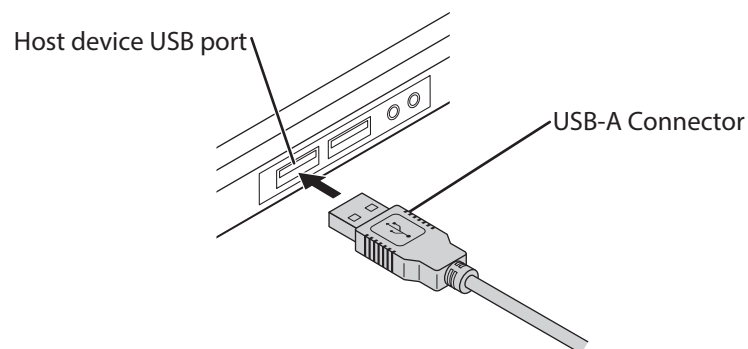

To connect the WB2F, open the Maintenance Port Hatch and insert the USB Mini-B connector.

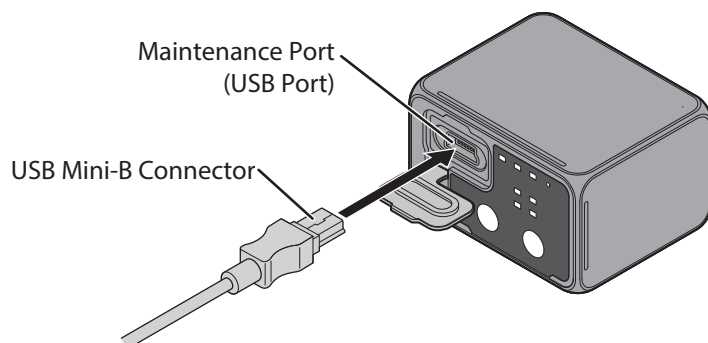

3 Operational Check

This section will describe how to check the WB2F's operations.

3.1 Performing an Operational Check using a PC

3.1.1 Necessary operating environment of the PC

Check to ensure that the PC fulfills the following conditions.

Item	Details
OS	Windows 7 / 8 / 8.1 / 10
Communication Port	USB2.0 or later

3.1.2 Installing the Device Driver

Prior to connecting the WB2F to a PC you must first install the USB device driver.

In order to install, refer to  [5. 14 Installing the USB driver] on page 5-31.

3.1.3 Connecting to a PC

● If you use a communication unit

If you use the WB2F with the communication unit, refer to [\[2. 3. 1 Wiring Instructions: Connecting the WB2F to the Communication Unit\]](#) on page 2-5 for wiring instructions.

After completing wiring, turn power ON

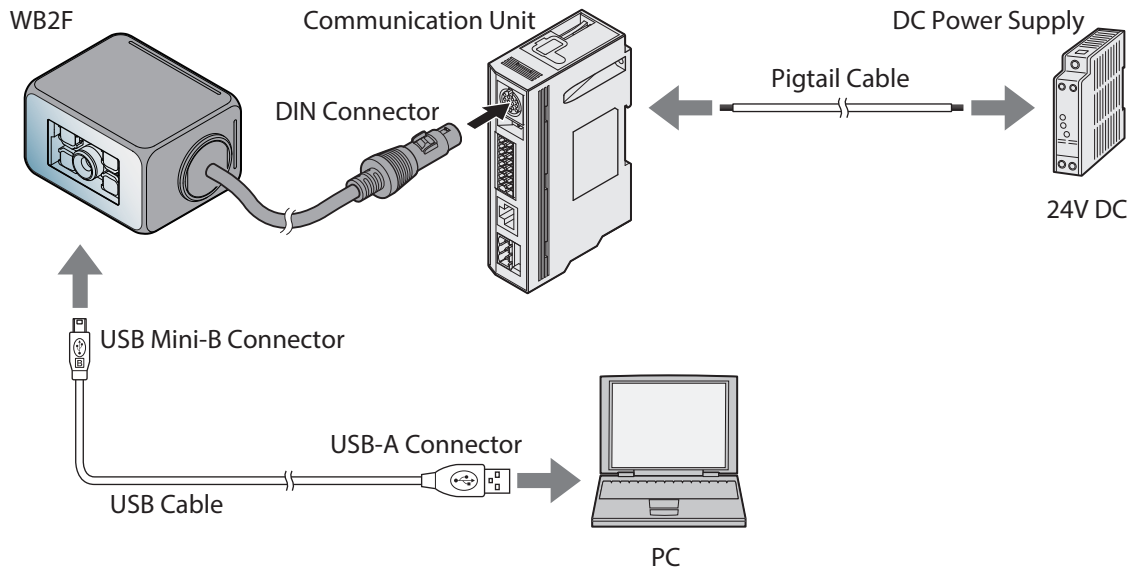

● If you do not use a communication unit

If you use the WB2F without the Communication Unit refer to [\[2. 3. 2 Wiring Instructions: Setting up the WB2F without the Communication Unit\]](#) on page 2-12.

After completing wiring, turn power ON

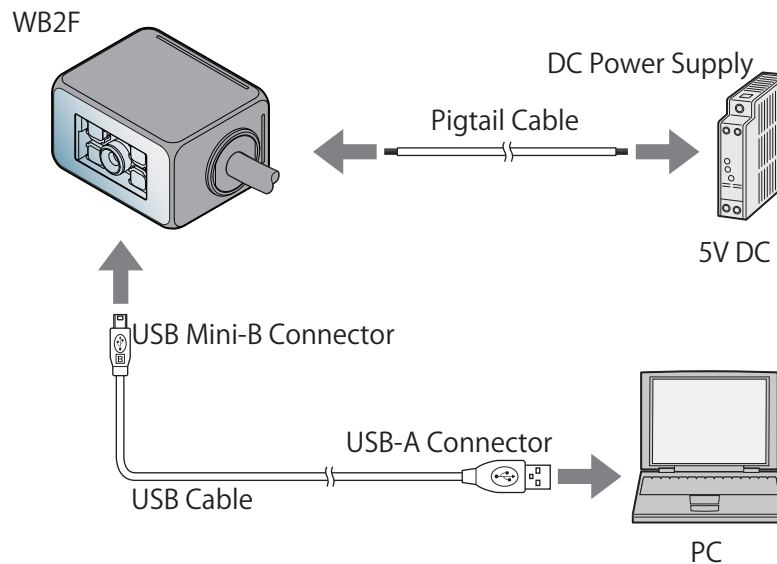

Caution

- Note, the DC power supply voltage requirements varies depending on whether you use a communication unit or not. Using a voltage level other than what is specified within this manual may result in damage and/or malfunction.
- Do not reverse the Power Supply connection. Doing so may result in damage.

3.2 Confirming a Successful Read

You can use the WB2F to confirm that a symbol was successfully read. Operate based on the procedure below.

1 Place the symbol within the Reading Range

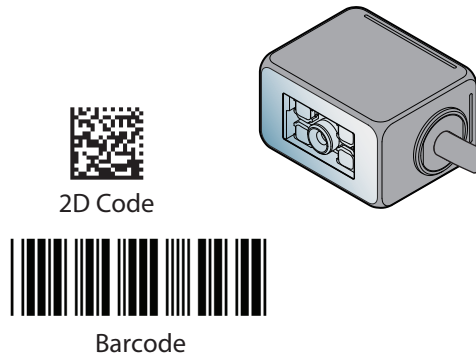

2 Push the READ/ENTER button while the power is ON Emitter LED continuously lights up as reading begins

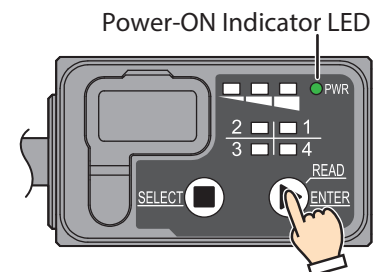

Due to the WB2F's settings, there are symbols that cannot be read. If you read a symbol double check the settings to ensure that the symbol is enabled.

3 You can confirm the Status of a read simply by looking at the Status LED lights

During Reading Operation	Read Success Time	Read Failure
<p>Status LED</p> <p>(R) (O) (G)</p> <p>During Reading Operation</p> <p>The Status LED (Orange) will continuously be ON during Reading Operations but will turn OFF once Reading Operations are terminated</p>	<p>Status LED</p> <p>(R) (O) (G)</p> <p>Read Success</p> <p>After a successful read the green status LED will turn ON (300ms)</p>	<p>Status LED</p> <p>(R) (O) (G)</p> <p>Read Failure</p> <p>After a read failure, or a reading timeout, the red status LED will turn ON (300ms)</p>



The Status LED settings can be changed. The settings here describe the default settings.

3.3 Symbol Read Data Confirmation

Confirm the data read by the WB2F by using a PC.
Operate based on the procedure below.

- 1** Install a generic terminal software onto the PC
WB2F's reading management will be done via the generic terminal software
- 2** Start up the generic terminal software, select the port the WB2F is connected to and begin communications
The Connector Port can be viewed from [Device Manager]
Because you are connecting via USB, there is no need to separately set communication speed.
- 3** Place the symbol within the reading range
- 4** Transmit the following command from a PC to the WB2F
Emitter LED continuously lights up as reading begins

Request	Control command (Transmitted Data PC)		
	Prefix	Mnemonic	Suffix
Read Start	^	get	CR LF



The prefix and suffix of Control Commands varies based on settings. The explanation in this manual assumes that factory default settings have been maintained.

- 5** Read Data can be confirmed via PC from the data the WB2F transmits
Read results can be determined by checking the Read data.

Read Result	Read Data (Data received from PC)		
	Global Prefix	Barcode Data	Global Suffix
Read Success	—	Such as 123456789	CR LF
Read Failure or Read Time Out	—	?	CR LF



The prefix and suffix of the read data varies based on settings. The explanation in this manual assumes that factory default settings have been maintained.

4 Function

This chapter describes the functions of the WB2F.

4.1 Overview











4.1.1 Operation mode

The functions that the WB2F can execute differ by the operation mode.

There are four operation modes: slave mode, setup support mode, maintenance mode, master mode.





■ Slave mode

This mode is used during normal operation. Slave mode has the following functions.

Function	Details	Reference page
Symbol reading	This function reads a symbol and outputs the reading results.	 Page 4-5
Output data additional information	This function adds various types of data when outputting the symbol reading results data.	 Page 4-15
Output data editing	This function outputs the symbol reading results data after editing it according to the specified method.	 Page 4-20
Verification	This function matches the symbol reading results data with the master data, judges whether or not it is matched, and outputs that.	 Page 4-22
Command alias	This function executes the control commands "start symbol reading" and "stop symbol reading" with other strings.	 Page 4-26
Communication command	This function transmits and receives data with the connected host device via the WB2F communication interface.	 Page 4-28
Parameter Changeover	This function automatically switches from Read Algorithm to Imaging parameters	 Page 4-31
Image Capture	This function stores code images within the WB2F during the decoding process	 Page 4-34
Image Filter	This function digitally correct captured images to improve reading performance.	 Page 4-37
I/O Function	This function utilizes external input and output terminals in order to determine the WB2F's operation and condition status.	 Page 4-40



■ Setup support mode

This mode is used to check the installation position and reading status of the WB2F. Setup support mode has the following function.

Function	Details	Reference page
Read Success Rate Measurement	This function outputs and displays Read Success Rate for a given symbol.	 Page 4-44
Decode Processing Time Measurement	This function outputs and displays the minimum, maximum and average symbol decoding time.	 Page 4-45
Symbol Position Measurement	This function outputs and displays a symbol's position information (coordinates)	 Page 4-46
Auto-tuning	This function automatically adjusts settings to optimal parameters for a given symbol and saves the settings in a parameter table.	 Page 4-48

■ Maintenance mode

This mode is used to maintain the WB2F after installation and to perform actions when problems occur. Maintenance mode has the following functions.

Function	Details	Reference page
Maintenance support	This function forcibly operates the unit with the factory default settings.	 Page 4-52
Firmware updating	This function updates the WB2F firmware.	 Page 4-52

■ Master mode

This mode is used to connect to a PLC with using its communication protocol. Master mode has the following functions.

Function	Details	Reference page
PLC connection	This function directly write reading results into the data memory of a PLC (programmable logic controller).	 Page 4-53

4.1.2 Operation mode switching operation and status

The operation mode is switched using the READ/ENTER button or communication commands.
For the communication commands, refer to [\[4.2.7 Communication command\]](#) on page 4-28.

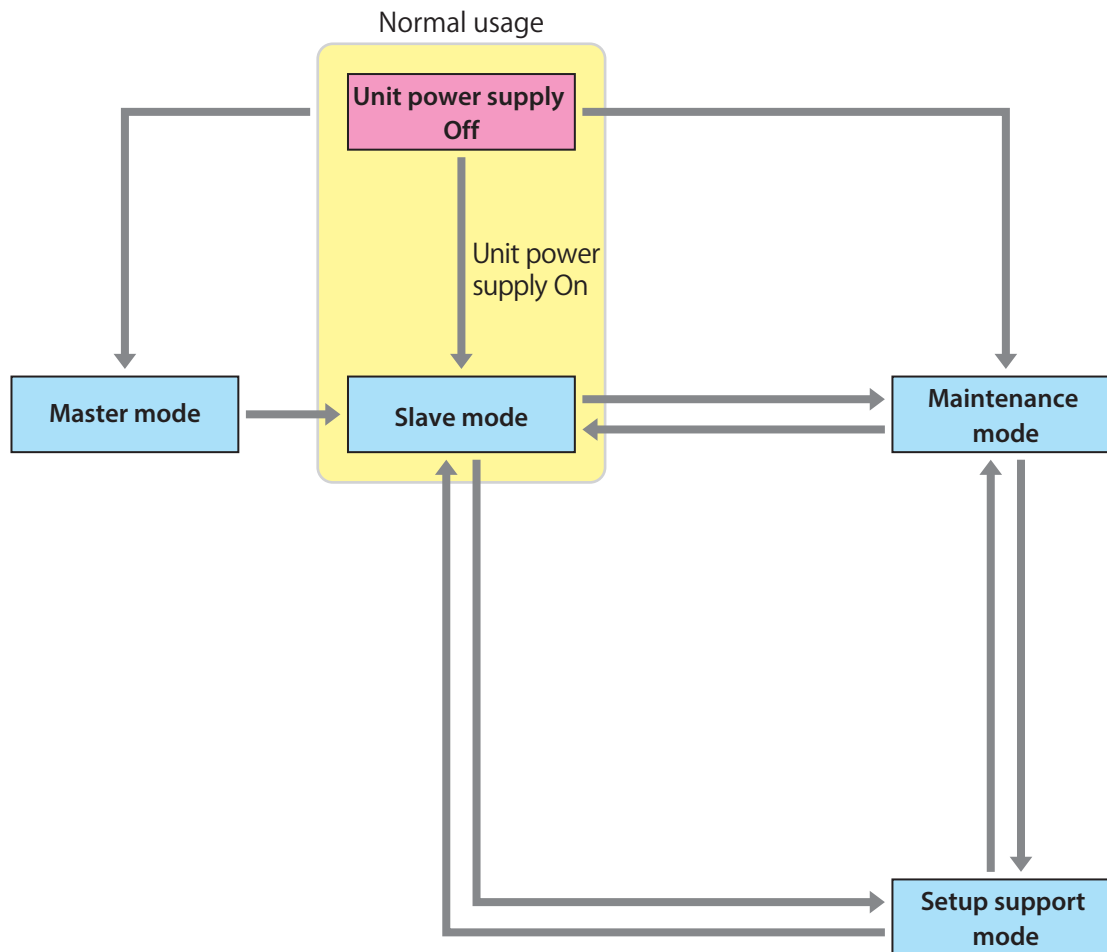

For details on the operation modes, refer to the following.











- Slave mode..... [Page 4-4](#)
- Setup support mode [Page 4-41](#)
- Maintenance mode..... [Page 4-50](#)
- Master Mode..... [Page 4-53](#)



Be aware that if you change the operation mode without executing the control command "Save setting values" after changing the set value, the set value will return to the state before change.

4.2 Slave Mode

This operation mode is used during normal operation. Use the unit in this mode after installation. Slave mode has the following functions.

- Symbol reading  Page 4-5
- Output data additional information  Page 4-15
- Output data editing  Page 4-20
- Verification  Page 4-22
- Command alias  Page 4-26
- Communication command  Page 4-28
- Parameter Changeover  Page 4-31
- Image Capture  Page 4-34
- Image Filter  Page 4-37
- I/O  Page 4-40

4.2.1 Switching operation to slave mode

There are two methods to switch to slave mode.

Use the methods according to the situation.

The status LEDs (red/orange/green) will turn off when switching to slave mode.

Method 1 Turn on the power to the unit. (Do not push the READ/ENTER button)

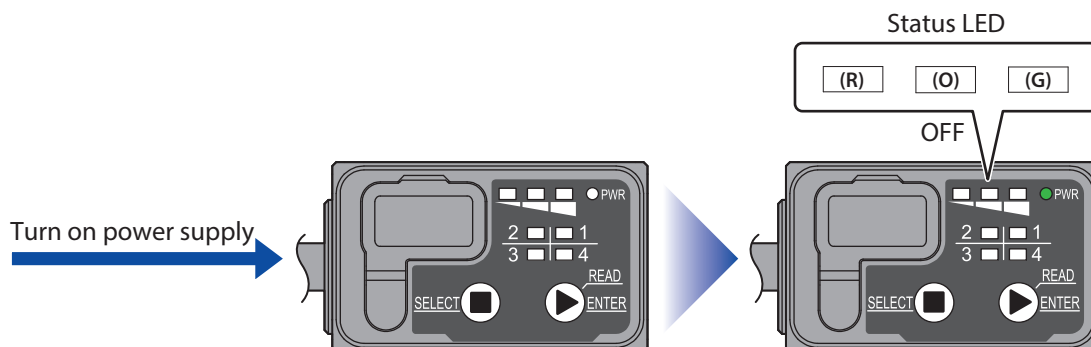

Method 2 Input the "switch to slave mode" control command.

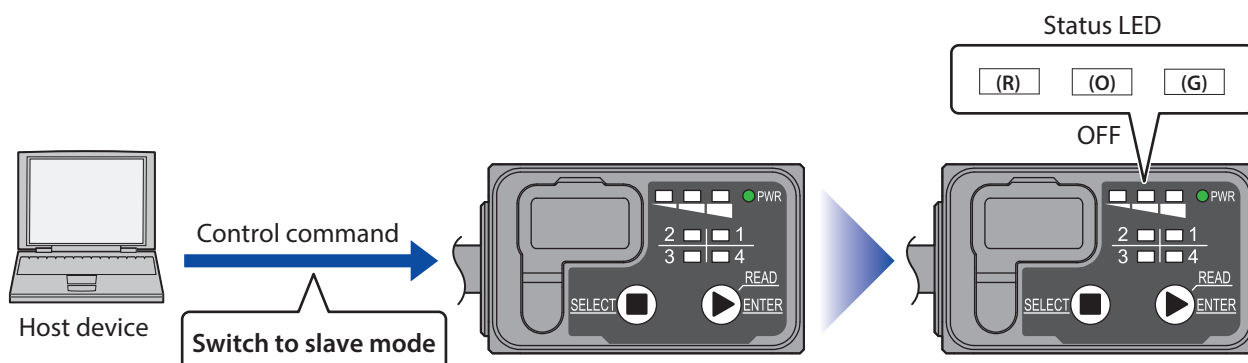

4.2.2 Symbol reading

The symbol reading reads symbols and outputs the reading result.



Refer to [\[4.6 Configuration Item Table\]](#) on page 4-54 for details on code reading functions and their various settings.

● Symbol Reading Method

There are three methods to start reading (reading request ON).

Method 1 Push the READ/ENTER button.

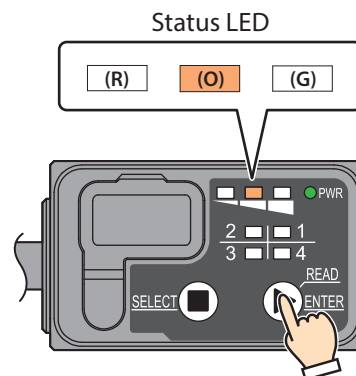

Method 2 Input Control Command [Start Reading].

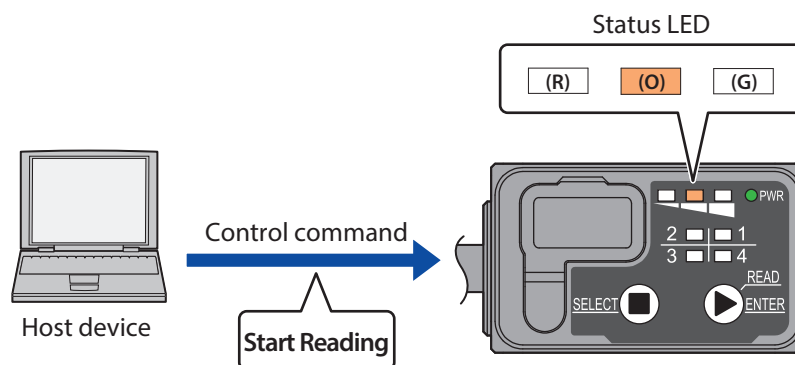



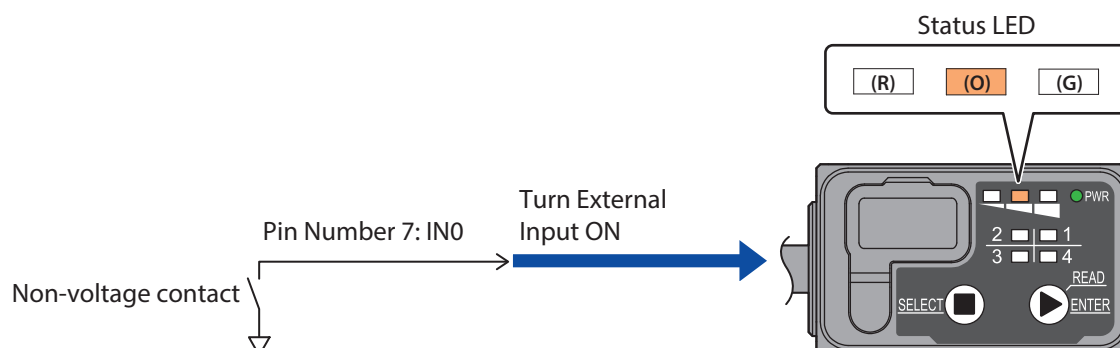

Method 3 Turn External Input ON.



- Do not use multiple methods to turn the reading request ON/OFF.
- Prior to setting External Input to trigger the reading request ON, set External Input function to [Start Reading]. For details refer to [\[4.2.11 I/O\]](#) on page 4-40.
- Reading Results can be set to reflect Status LED, External Output and the Communication Interface.
- The Status LED (Orange) will turn ON during Reading Operations. To customize Interlock Control, Lighting Patterns, and Light On Times, refer to [\[4.6 Configuration Item Table\]](#) on page 4-54.



● Symbol Reading

There are three types of Symbol Reading.

- Single Read..... Page 4-6
 - Edge Activation..... Page 4-7
 - Level Activation Page 4-8
- Multi-read Sequential Output Page 4-9
- Multi-read Batch Output Page 4-10

Single Read

For a single read: Once the Reading Request is turned on, the symbol reading operation commences. Once either Reading Success is attained or Reading Time Out elapses, the Reading result is output. 1 read is executed per 1 Reading Request. There are two types of single read operations.

- Edge Activation Page 4-7
- Level Activation Page 4-8

■ Edge Activation

After detecting that Reading Request has been activated (OFF → ON), symbol reading will commence.

If the Reading Time Out time has been set to anything other than infinite, Edge activation will occur. For details refer to [\[4. 6 Configuration Item Table\]](#) on page 4-54.

If Reading Request was turned on by External Input, conditions for activating Stop Reading is one of the following:

- Reading Success
- Reading Timeout Elapsed

To control the READ/ENTER button or Reading Request using control commands, refer to [\[Start Reading and Stop Reading conditions for each Reading Request\]](#) on page 4-11.

The following timing chart is an example of an operation with the External Input.

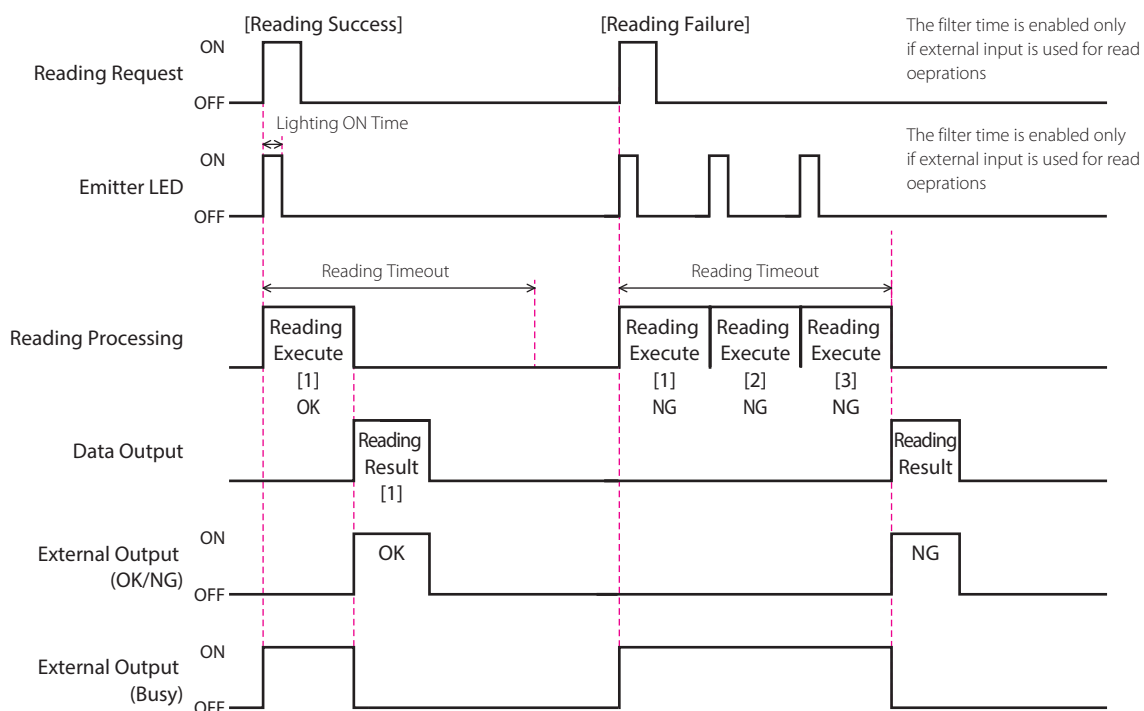

- Operation of the External Input and the External Output will vary depending on settings parameters.
- If Reading Linked Control parameter is enabled, the Status LED (orange) will turn ON when symbol reading starts. Turns off when either the illumination time elapses or symbol reading stops.
- If Reading Linked Control parameter is enabled, the Status LED (Green/Red) will turn ON when symbol reading stops. Turns off when either the illumination time elapses or symbol reading starts.
- If Reading Linked Control parameter is enabled, the WB2F will determine Reading Success/Reading Failure or Verification Match/Verification Un-match when symbol reading stops and perform output control based on the parameters that are set.

■ Level Activation

If Reading Request is turned ON, symbol reading commences and as long as Reading Request remains ON, symbol reading will continue.

If Read Time Out time is set to infinite, Level activate will occur. For details refer to [🔗 \[4.6 Configuration Item Table\]](#) on page 4-54.

If Reading Request was turned ON by External Input, conditions for activating Stop Reading is one of the following:

- Reading Success
- External Input OFF (Reading Request OFF)

To control reading requests using the control command, refer to [🔗 \[Start Reading and Stop Reading conditions for each Reading Request\]](#) on page 4-11.

The following timing chart is an example of an operation with External Input.

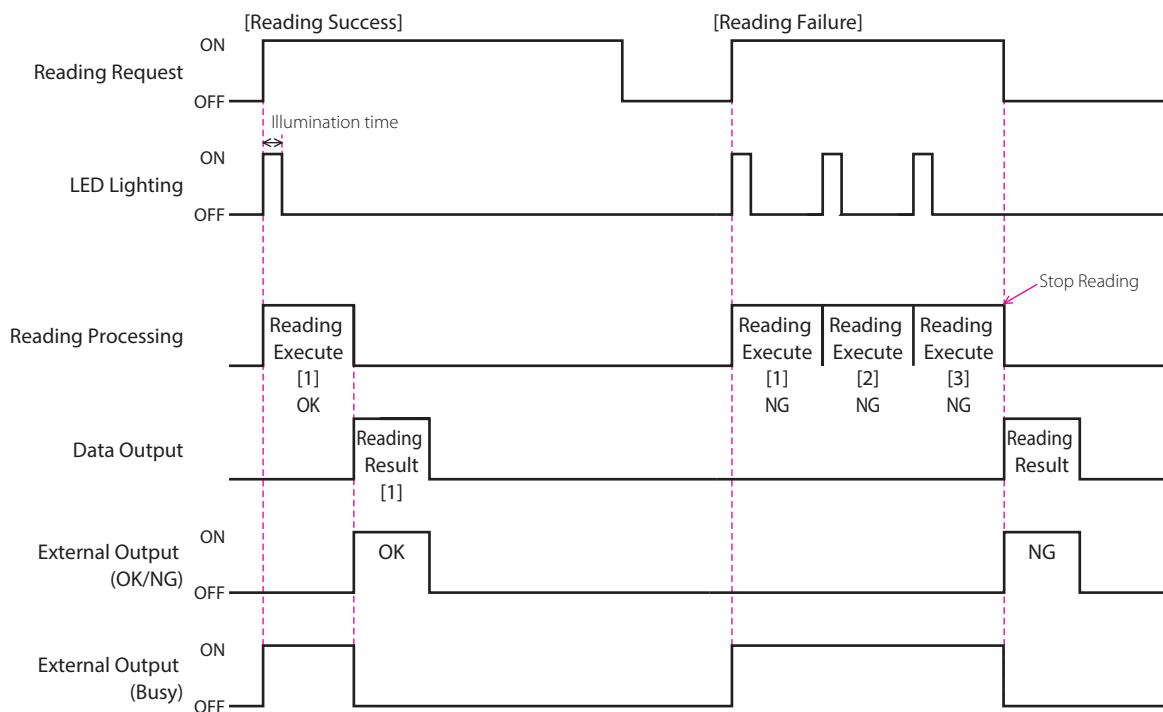

- Operation of the External Input and the External Output will vary depending on settings parameters.
- If Reading Linked Control parameter is enabled, the Status LED (orange) will turn ON when symbol reading is ON. Turns OFF when either the illumination time elapses or symbol reading stops.
- If Reading Linked Control parameter is enabled, Status LED (Green/Red) will turn ON when symbol reading stops. Turns OFF when either the illumination time elapses or symbol reading starts.
- If Reading Linked Control parameter is enabled, the WB2F will determine Reading Success/Reading Failure or Verification Match/Verification Un-match when symbol reading stops and perform output control based on the parameters that are set.

Multi-Read Sequential Output

If Reading Request is turned ON, symbol reading commences and will continue for as long as Reading Request remains ON. The WB2F will output the Reading Result for each symbol that is read.

Once Reading Request is turned OFF, symbol reading will stop.

if Reading Timeout is set to infinite, Level Activate will occur. For all other cases, Edge Activate will occur.

For more details refer to [\[4. 6 Configuration Item Table\] "Symbol Reading"](#) on Page 4-58.

If Reading Request was turned ON by external input and level activation, conditions for activating Stop Reading is as follows:

- External Input OFF

To control Reading Request using control commands, refer to [\[Start Reading and Stop Reading conditions for each Reading Request\]](#) on page 4-11.

The following timing chart is an example of an operation with both the External Input and Level Activation

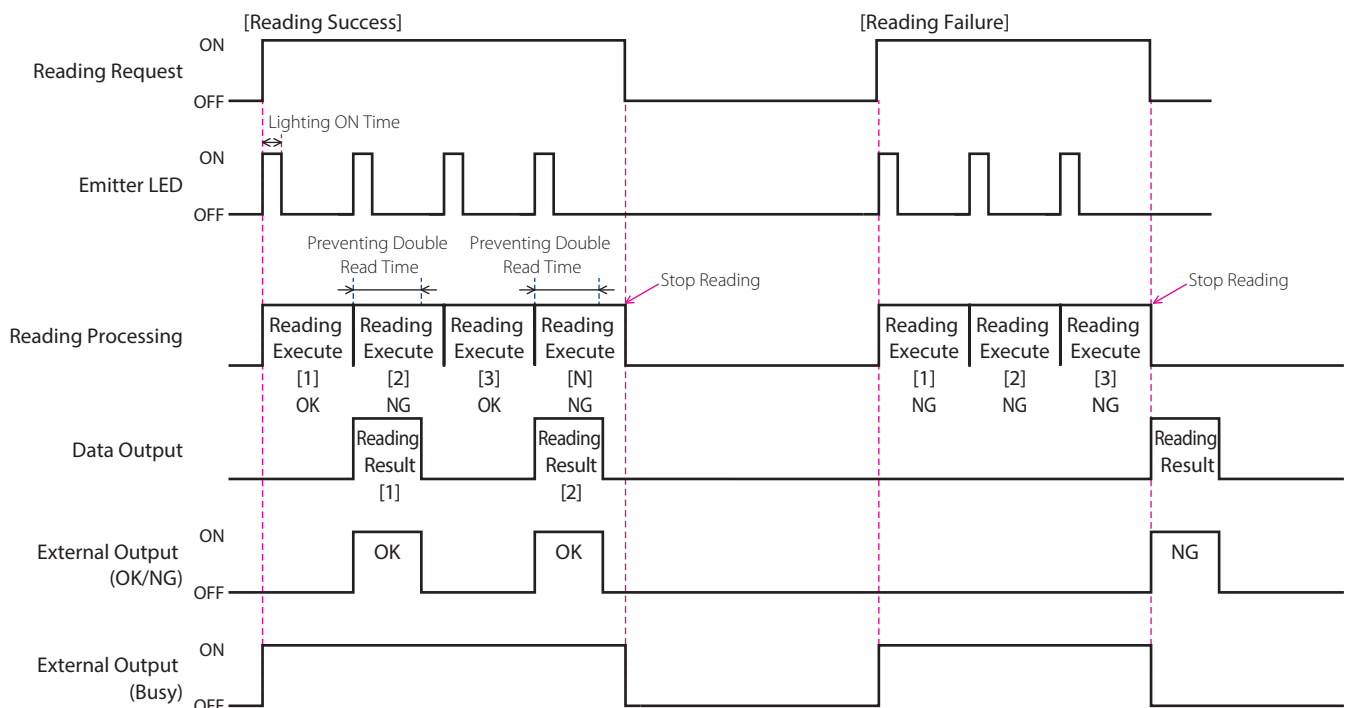

- Preventing Double Read Time setting range is 100ms to 25,500ms
- Even if the Preventing Double Read Time has passed, symbol reading will not begin until communication response has been established.
- To prevent reading the same symbol twice, the WB2F will not acknowledge symbols with the same symbology and data as the prior symbol during the Preventing Double Read Time. However, this does not apply to symbols that have either different symbology or data.
- If you turn Reading Request OFF before the WB2F is able to read a single symbol, it will be treated as a Reading Failure.
- Operation of the External Output will change based on how its settings are configured.
- If Reading Linked Control parameter is enabled, the Status LED (orange) will turn ON when symbol reading is ON. Turns OFF when either the Illumination Time elapses or symbol reading stops.
- If Reading Linked Control parameter is enabled, the Status LED (Green/Red) will turn ON when symbol reading stops. It will turn OFF when the Illumination time elapses, or symbol reading starts.
- If Reading Linked Control parameter is enabled, the WB2F will determine Reading Success/Reading Failure or Verification Match/Verification Un-match when symbol reading stops and perform output control based on the parameters that are set.

Multi-Read Batch Output

If Reading Request is turned ON, symbol reading commences and will continue for as long as the Reading Request remains ON. Once the Reading Request is turned OFF, symbol reading will cease and the Reading Results will be output in batch. The maximum number of symbol data that can be output at once is 32. Symbol data for the Symbol Reading past that will be discarded.

If the Reading Timeout is set to infinite, Level Activate will occur. For all other cases, Edge Activate will occur.

For more details, refer to [\[4. 6 Configuration Item Table\]](#) on page 4-54.

If the Reading Request was turned ON by the external input and level activation, conditions for activating the Stop Reading is as follows:

- External Input OFF

To control the Reading Request using control commands, refer to [\[Start Reading and Stop Reading conditions for each Reading Request\]](#) on page 4-11.

The following timing chart is an example of an operation with both the External Input and Level Activation

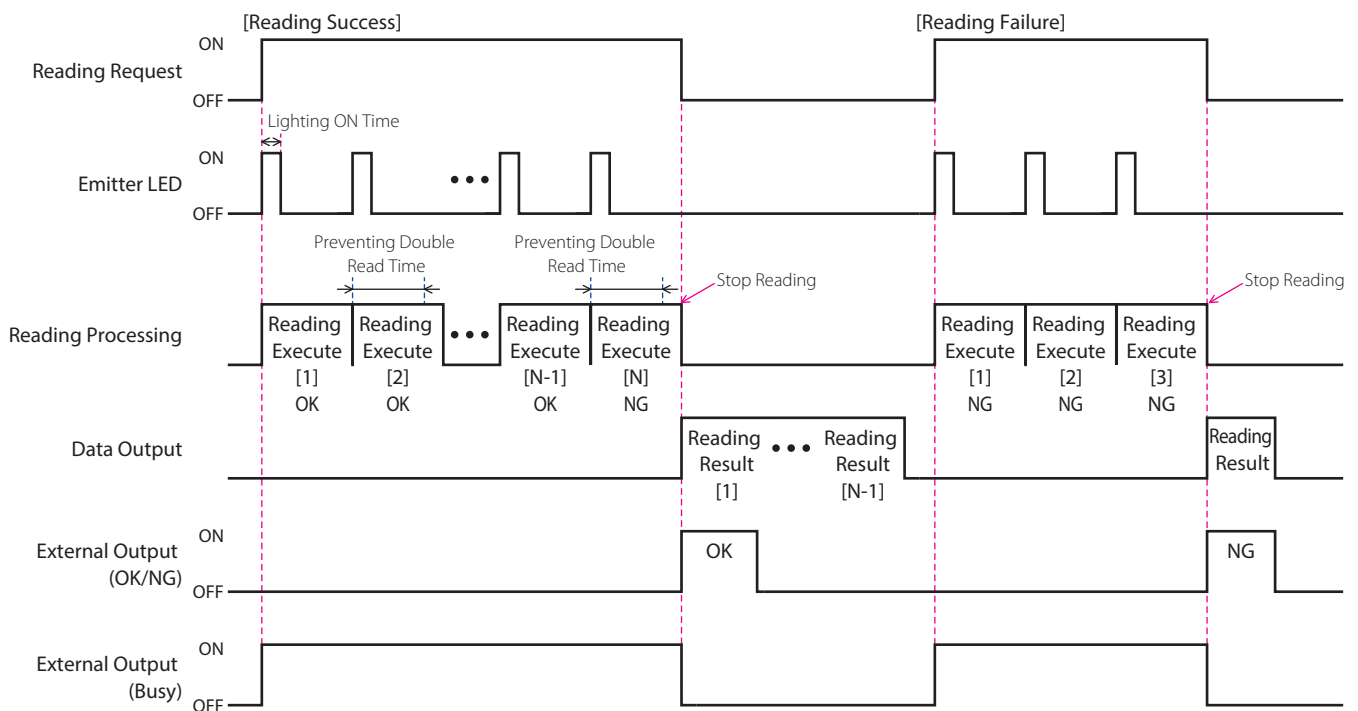

- The sum of the characters of Reading Results [1] to [N] must be under 10,000 characters. If the total number of characters exceeds 10,000, the accuracy of the output results is not guaranteed.
- Preventing Double Read Time setting range is 100ms to 25,500ms
- To prevent reading the same symbol twice, the WB2F will not acknowledge symbols with the same symbology and data as the prior symbol during the Preventing Double Read Time. However, this does not apply to symbols that have either different symbology or data.
- The External Output, the Status LED (Green/Red) will show only the WB2F's last Reading Result.
- Operations of the External Output and the Status LED will change based on how settings are configured
- If Reading Linked Control parameter is enabled, the Status LED (orange) will turn ON when symbol reading starts. Turns OFF when either the Illumination Time elapses or symbol reading stops.
- If Reading Linked Control parameter is enabled, the Status LED (Green/Red) will turn ON when symbol reading stops. It will turn OFF when the Illumination Time elapses, or symbol reading starts.
- If Reading Linked Control parameter is enabled, the WB2F will determine Reading Success/Reading Failure or Verification Match/Verification Un-match when symbol reading stops and perform output control based on the parameters that are set.

● Start Reading and Stop Reading conditions for each Reading Request

Symbol Reading and Reading Request			Operation	
Symbol Reading	Reading Timeout	Reading Request	Start Reading Conditions	Stop Reading Conditions
Single Read	100ms to 25,500ms (Edge Activation)	READ/ENTER button	Push the READ/ENTER button	<ul style="list-style-type: none"> • Reading Success • Reading Timeout (5s) Elapsed
		External Input	External Input OFF → ON	<ul style="list-style-type: none"> • Reading Success • Reading Timeout Elapsed
		Control command	Start Reading Command Input	<ul style="list-style-type: none"> • Reading Success • Reading Timeout Elapsed • Input Stop Reading Command
	Infinite (level activate)	READ/ENTER button	*1	
		External Input	External Input ON (Continues to read only while Trigger is ON)	<ul style="list-style-type: none"> • Reading Success • External Input OFF
		Control command	Read Start Command Input	<ul style="list-style-type: none"> • Reading Success • Input Stop Reading Command
Multi-Read Sequential Output	100ms to 25,500ms (Edge Activation)	READ/ENTER button	*1	
		External Input	External Output OFF → ON	<ul style="list-style-type: none"> • Reading Timeout Elapsed
		Control command	Start Reading Command Input	<ul style="list-style-type: none"> • Reading Timeout Elapsed • Input Stop Reading Command
	Infinite (level activate)	READ/ENTER button	*1	
		External Input	External Input ON (Continues to read only while Trigger is ON)	<ul style="list-style-type: none"> • External Input OFF
		Control command	Start Reading Command Input	<ul style="list-style-type: none"> • Input Stop Reading Command
Multi-Read Batch Output	100ms to 25,500ms (Edge Activation)	READ/ENTER button	*1	
		External Input	External Output OFF → ON	<ul style="list-style-type: none"> • Reading Timeout Elapsed
		Control command	Start Reading Command Input	<ul style="list-style-type: none"> • Reading Timeout Elapsed • Input Stop Reading Command
	Infinite (level activate)	READ/ENTER button	*1	
		External Input	External Input ON (Continues to read only while Trigger is ON)	External Input OFF
		Control command	Start Reading Command Input	Input Stop Reading Command

*1 Symbol Reading executed via the READ/ENTER button forcibly executes fixed operation of single read edge activation (Reading Timeout: 5s)



If you initiate symbol reading using a Control Command, after the symbol reading is stopped, Reading Request will automatically turn OFF

● Multiple Symbol Read (Differs from Multi-Read)

Multiple symbol read will continue to execute reads until the maximum number of symbol readings is attained. Symbol Reading will cease and results will be output in batch if either maximum number of symbol readings is attained, Stop Reading is entered or Reading Timeout elapses. This function is compatible with Single Read, (edge activation/level activation) only.

If number of symbol readings

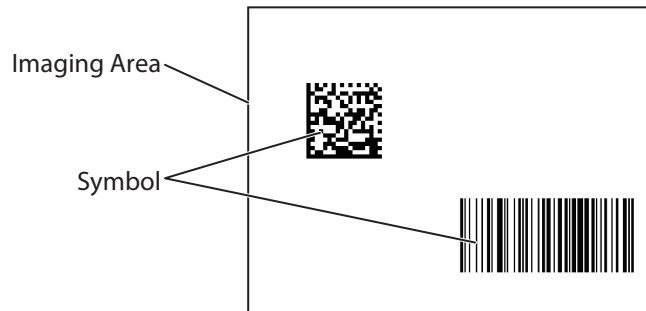

Output Format is as follows

Global Prefix	The First One Reading Result	Batch Output Separator	Global Prefix
Second Time. Reading Result	Batch Output Separator		Global Suffix



- Symbol Reading
- At most 32 items can be simultaneously read.
- Can be used even if there are various symbologies in the imaging area at once.
- If there is more than one of the same symbol (same symbology and data) in the imaging area, the WB2F will treat them as one symbol.
- A maximum of 8 characters can be set for the Batch Output Separator.
- If the number of symbols placed in the imaging area exceeds the max number of symbols that was entered in the scanner's settings, the WB2F will only read and output up to the max number of symbols determined in the settings.

The multiple symbol read example below assumes that number of symbol readings is set to "04H"(4).

Operational Example 1 If during 1 read, the WB2F is able to read the symbol 4 times "04H"...

- First Read

Symbol A, B, C, D Successfully Read

Because the maximum number of allowed symbols have been read, reading will stop and results will be output.

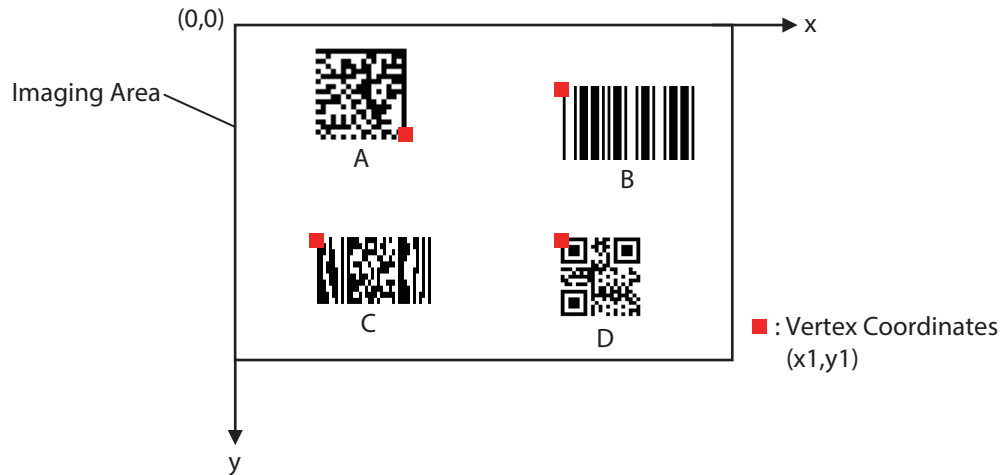

The coordinates of each symbol will be output in order of closeness of the y axis value to 0. If two coordinates have identical y values, the symbol with the x axis closer to 0 will be input first. Refer to [\[Examples: \(Additional Information\)\]](#) on page 4-18.

Output Result is as follows

Global Prefix	Symbol B Reading Result	Batch Output Separator	Global Prefix	Symbol A Reading Result	Batch Output Separator
Global Prefix	Symbol C Reading Result	Batch Output Separator	Global Prefix	Symbol D Reading Result	Global Suffix

Operational Example 2 When the number of symbol readings reaches "04H" ("4") with multiple reads.

• First Read

Symbol A and C were successfully read, Symbol B and D were not.

Because the number of symbol readings has not reached the maximum allowed, reading will continue.

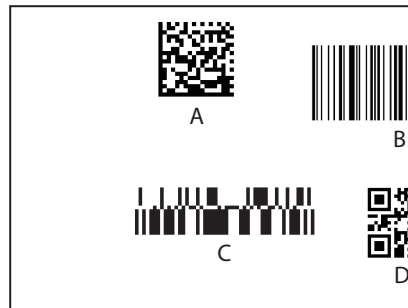

• Second Read

Because Symbol A and C were successfully read on the first try, they will not undergo second read processing.

Symbol B has again been successfully read. Because Symbol B has been read twice which is equivalent to the Symbol Read Number, Reading will halt and result data will be output.

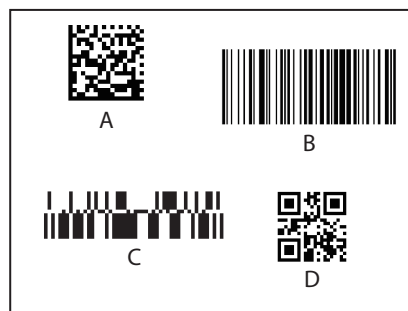

Reading Results of each symbol will be output in the order they were successfully read.

Output Result is as follows

Global Prefix	Symbol A Reading Result	Batch Output Separator	Global Prefix	Symbol C Reading Result	Batch Output Separator
Global Prefix	Symbol B Reading Result	Batch Output Separator	Global Prefix	Symbol D Reading Result	Global Suffix



Regarding the Order of Output

If you read multiple symbols, note the following points.

Output result will output results in the order that they were successfully read.

Reading Success Order depends on various external factors such as image acquisition timing.

4.2.3 Output data additional information

Output data additional information is used to add additional information to Reading Result. When performing a data output from a host device, there are two different types of data.



For more information on Output Data Additional Information, refer to [\[4.6 Configuration Item Table\]](#) on page 4-54.

● Single Read or Multi-read sequential output format

Global Prefix	Reading Result Data	Global Suffix
---------------	---------------------	---------------

- If a Reading Success occurs, the read data will be input as [Reading Result Data]
- If a Reading Failure occurs, the 8 character Reading Failure Output characters set in advance will be input as the [Reading Result Data]
- A maximum of 8 characters each can be set for both [Global Prefix] and [Global Suffix]

● Multiple Symbol Read or Multi-read Batch Output format

- You have the option to set [Batch Output Separator] in the separation of Reading Results instead of [Global Suffix]. However, the last separation in the Reading Result will always be [Global Suffix]
- Like the [Global Suffix], the [Batch Output Separator] can be set with a maximum of 8 characters.

e.g. Output 4 different Reading Results

- If not using the "Batch Output Separator"

Global Prefix	Reading Result Data	Global Suffix
Global Prefix	Reading Result Data	Global Suffix
Global Prefix	Reading Result Data	Global Suffix
Global Prefix	Reading Result Data	Global Suffix

- If using the "Batch Output Separator"

Global Prefix	Reading Result Data	Global Separator
Global Prefix	Reading Result Data	Global Separator
Global Prefix	Reading Result Data	Global Separator
Global Prefix	Reading Result Data	Global Suffix



To more easily manage output data after a batch output is performed, set up the [Global Suffix] with new line characters and set up the [Batch Output Separator] with new line characters other than **CR** **LF** .

To more easily manage output data after a batch output is performed, set up the [Global Suffix] with new line characters and set up the [Batch Output Separator] with new line characters other than **CR** **LF** .

^ABCDE:^12345:^abc:^98765:^VWXYZ **CR** **LF**

● During verification execution

Global Prefix	Verification Result	Reading Result Data	Global Suffix
---------------	---------------------	---------------------	---------------

- If you are using the Verification, [Verification Result] will be entered before [Reading Result]
- If Verification is a match, the following string is entered before [Verification Result]

<OK:xxx>

The Master data number that matched with the [Reading Result Data] will be entered as xxx (3 digit number) in decimal form.

When successive input data collation result is a match, 255 is entered.

- If the result is not a match, the following character string will be entered into the [verification result]



<NG:--->

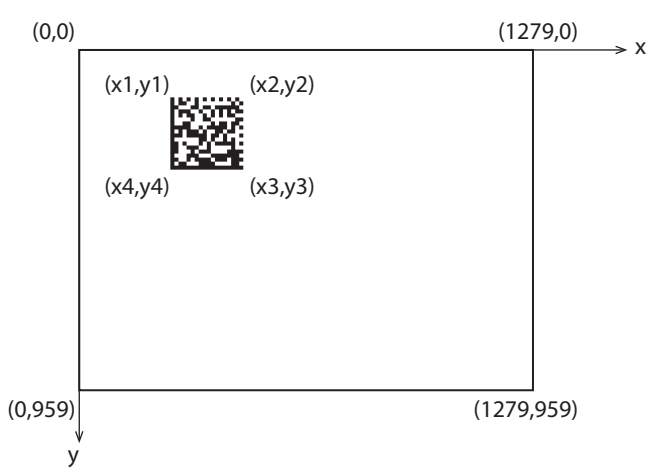
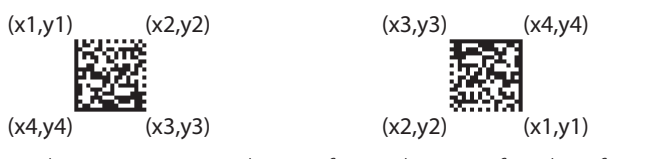

If you execute verification, [Verification Results] will always be input

● Examples: (Additional Information)



Item	Examples: (Additional Information)	Note
Global Prefix	^	Suffix with a maximum of 8 characters that can be added to any data output.
Local Prefix	P00;	Suffix that can be added to each symbol type. A maximum of 4 characters can be added.
Data size	1234	Output Data size increases in 1 byte increments. It will be expressed in 4 digit decimal form. Zero suppress is not performed.
Elapsed time	12:34:56	Elapsed time since powering on the main unit will be added in the form HH:MM:SS. If reset it will revert back to "00:00:00" The time after 23:59:59 will also revert back to "00:00:00"
AIM ID	JE0	Will add the symbol data's AIM ID. If read failure occurs, "]" will be added instead.
Position Information	P= (0000,0000) (1279,0000) (1279,0959) (0000,0959)	<p>Adds the symbol's position information in coordinate form. The function will not include the quiet zone in position information. Output format : (x1, y1)(x2, y2)(x3, y3)(x4, y4) * (x1, y1) to (x4, y4) : symbol vertex coordinates (x=0 to 1279)(, y=0 to 959) Can add "P=" (where P is the coordinates) prior to the digit. Coordinate definition will be as follows:</p>  <p>Coordinate output order will differ based on symbol orientation</p>  <p>To obtain vertex coordinates for each type of code refer to [5. 13 Sample labels] on page 5-28.</p>
Number of Characters	N=0123	Will add the symbol data's number of characters. Will be expressed as a 4 digit decimal number. Zero suppression is not performed. Can add "N=" (where N is the symbol length) prior to the digit

Item	Examples: (Additional Information)	Note
Verification Results	<OK:000>	During verification, Match/Unmatch results will be added. Once verified, the characters OK and the matched master data number (3 characters) will be added. When read data matches sequentially inserted master data, "<OK:255>" will be added. If mismatched, "<NG:--->" will be added. Will only be added during verification.
Local Suffix	S00;	Suffix that can be added to each symbol type. A maximum of 4 characters can be added.
Check Digit	12	Will add a check digit in the form of 2 digit hexadecimal number. Refer to  [5. 8 Check digit calculation method] on page 5-21 for calculation methods.
Global Suffix	 	Suffix with a maximum of 8 characters that can be added to any data output.



The order in which additional information will be added is as follows:

[Global Suffix][Local Suffix][Data Size][Elapsed Time][AIM ID]{Position Information}_[symbol length],[Verification Result][Reading Result Data][Local Suffix][Check Digit][Global Suffix]

e.g. If all additional information examples outlined  [Examples: (Additional Information)] on page 4-18 were added to symbol data "ABCD"the following data will be transmitted.

^P00;1234_12:34:56_]E0_P=(0000,0000)(1279,0000)(1279,0959)(0000,0959)_N=0123_<OK:000>ABC-DEFGS00;12  

e.g. If all items except [AIM ID] outlined  [Examples: (Additional Information)] on page 4-18 were added to symbol data "ABCDEFG"the following data will be transmitted.



^P00;1234_12:34:56_P=(0000,0000)(1279,0000)(1279,0959)(0000,0959)_N=0123_<OK:000>ABC-DEFGS00;12  



- If you add additional data such as [Data Size], [Elapsed Time], {Aim ID}, {Position Information} and [symbol length], an item separator "_" will be affixed to the end of each of the added data. If you do not add any additional data, the item separator will not be affixed.
- The order of the items cannot be changed.
- Label options such as Position Information "P="and symbol length "N="can be set to activate/deactivate in settings.

4.2.4 Output data editing

Output data editing edits designated Reading Result and outputs the data. The editing method can be used either separately or in combination with each other.

- Extraction and Integration of Reading Result Data....  Page 4-20
- Control Code Replacement.....  Page 4-21



Output data editor function's various settings are outlined in  [4.6 Configuration Item Table] on page 4-54.

● Extraction and Integration of Reading Result Data

Extracts, combines and outputs only the required portions from Read Result Data.

To begin extraction, determine start location and number of characters to extract. Up to 4 (0-3) extractions can be set. Extrated data will be compiled, ordered from Extraction 0 and output as one.

e.g. Setting up Extraction 0 to 3 with the following parameters.

Extraction Number	Extraction Begin Location	Number of Extraction characters
Extraction0	0	4
Extraction1	6	5
Extraction2	9	6
Extraction3	4	3

Extraction Operation is as follows:

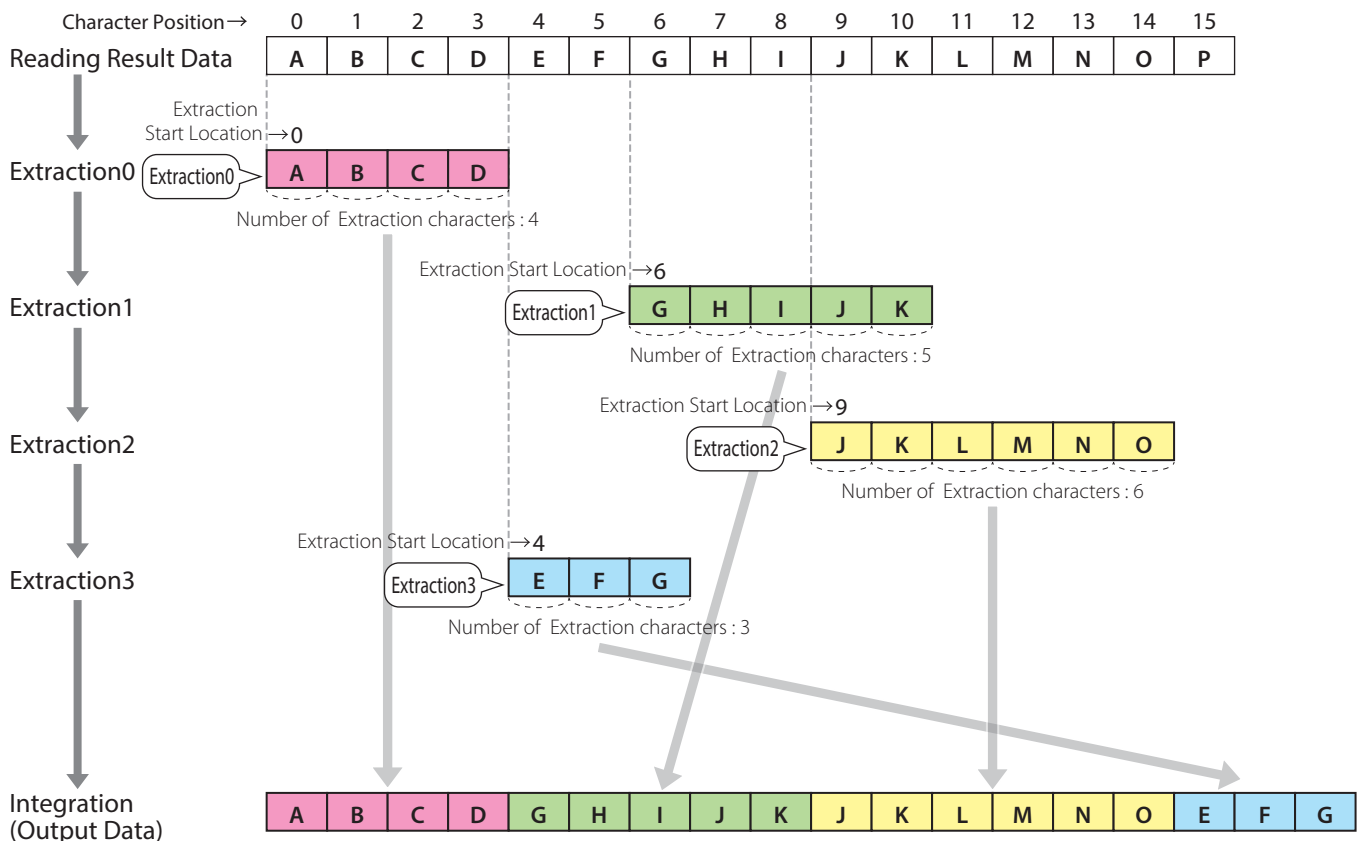

- Irregardless of where Extraction Start Location is set, the order of extraction will always be Extraction 0, Extraction 1, Extraction 2, Extraction 3.
- Data Extraction and Integration will only be executed if the read is successful.

● Control Code Replacement

If control code (00H-1FH, 7FH) is included in Reading Result Data, characters will be replaced by designated characters (replacement characters) prior to output.

e.g. Setting up a replacement character with the following parameters.

Character Code → 40H

Replacement Character → @

The command code replacement occurs as follows.

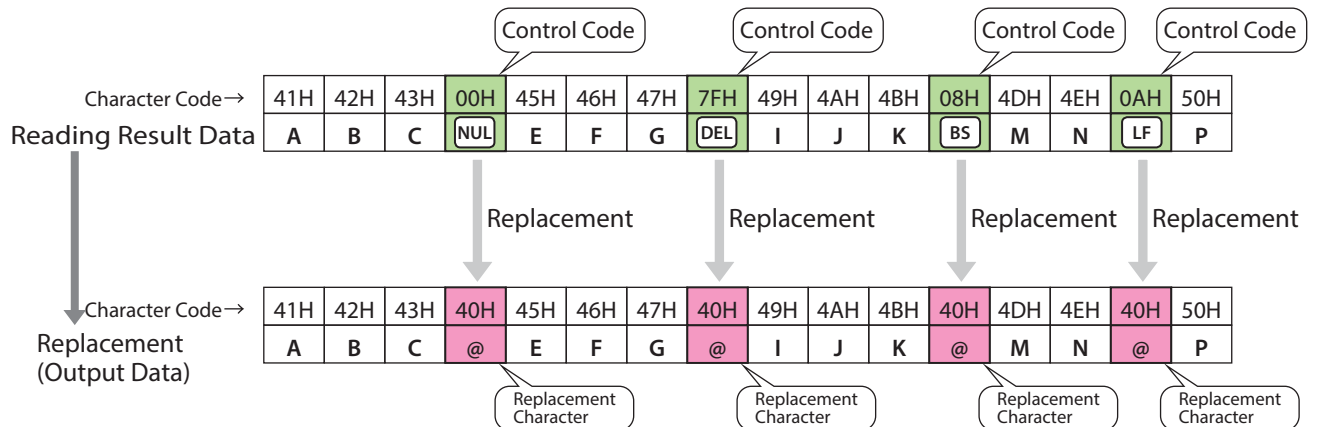



- You cannot use **NUL** (00H) as a replacement character.
- If Data extraction and integration are enabled, command code replacement will be executed after the extraction and integration are completed.
- Control Code Replacement is executed only if the read was successful.

4.2.5 Verification

Verification compares Reading Result Data with the master data and determines match/unmatch.

Determination Result can be set to reflect the Status LED, External Output and communication interface

There are two methods for determination. Each of these verification methods can be used either on their own or in combination with each other.

- Pre-registering Master Data  Page 4-22
- Master Data Sequential Input  Page 4-24



For more details on setting up the verification function, refer to  [4. 6 Configuration Item Table] on page 4-54.

● Pre-registering Master Data

Reading Result Data will be verified against master data that has been registered in advance on the main unit.

You can register up to 16 types of master data, each with a maximum of 64 characters

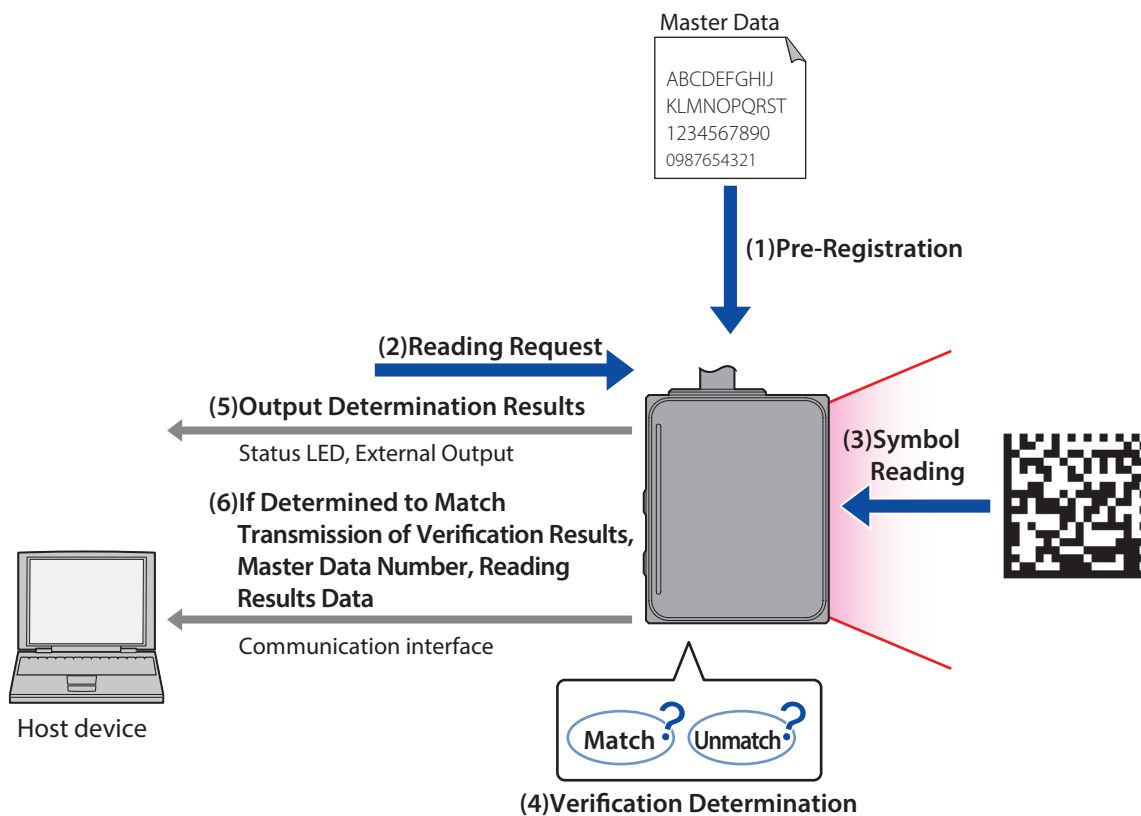

You can pre-register master data by inputting set up commands. For details refer to [\[4. 6 Configuration Item Table\]](#).

e.g. Pre-Registering Master Data.

e.g. Registration of the following contents.

Master Data
123
123456
abc
ABC

1 Enables Verification Function

2 Will be registered in master data

Register "123" to Master Data [0], "123456" to Master Data [1], "abc" to Master Data [3], "ABC" to Master Data [3]

Registered Number of Characters	0	1	2	3	4	5	6	...	63
Master Data[0]	31H	32H	33H	00H	00H	00H	00H	...	00H
Master Data[1]	31H	32H	33H	34H	35H	36H	00H	...	00H
Master Data[2]	61H	62H	63H	00H	00H	00H	00H	...	00H
Master Data[3]	41H	42H	43H	00H	00H	00H	00H	...	00H

3 Will be verified against the Master Data

If symbol "123" is successfully read, the WB2F will output the following

<OK:000>123 **CR** **LF**

If symbol "AbC" is successfully read, the WB2F will output the following

<NG:--->AbC **CR** **LF**

● Master Data Sequential Input

By inputting Control Command [Verification Start] and inputting the Master Data, the Reading Result Data will be compared with the Master Data.

The Inputted Master Data will be discarded after verification is complete.

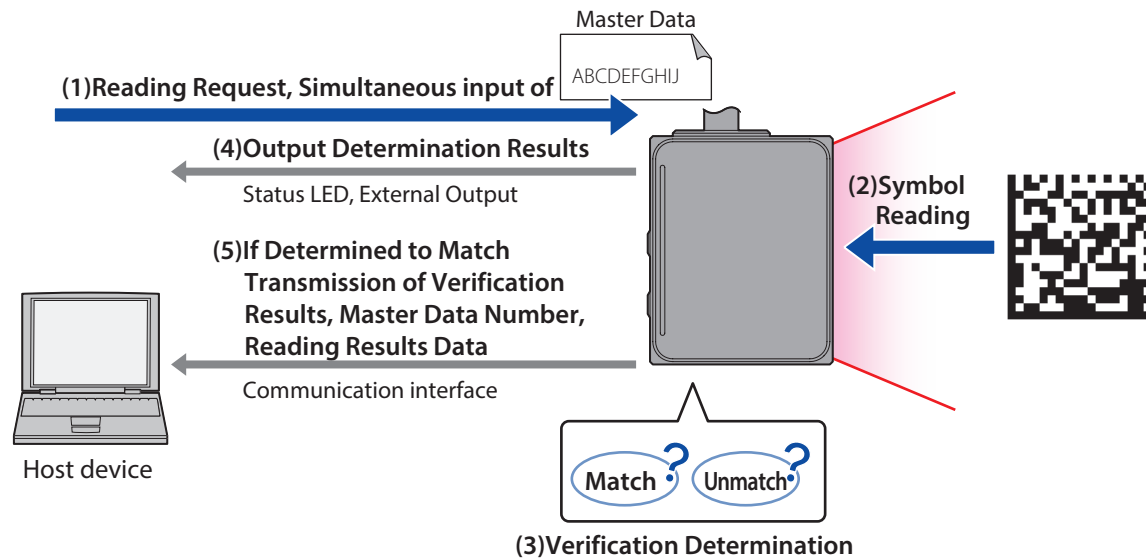

Master data can be input by utilizing control commands. For details refer to [\[5. 13 Sample labels\]](#) on page 5-28.

e.g. Sequential Input of Master Data.

Registration of the following contents.

Master Data
123456

1 Enter [Verification Start] listed [\[5. 6 List of Control Commands\]](#) on page 5-13.

`^cmp123456`

2 Will be verified against master data

If symbol "123456" is successfully read, the WB2F will output the following

`<OK:255>123456`

If symbol "123" is successfully read, the WB2F will output the following

`<NG:--->123`



- Pre-registering master data and sequential input can be used in combination with each other. It may be useful to pre-register master data that requires constant verification and to sequentially input master data values that only require verification on a temporary basis
- This function can be executed with only a command.
- Master data can be input with a maximum of 64 characters.
- Sequential input of master data is possible without enabling verification function

● Verification Determination

Verification between Reading Result Data and master data is judged by partial match

e.g. If master data is "ABC", verification determination of Reading Result Data is as follows

Reading Result Data	Determination Result
ABC	Match
ABCDEFGHIJ	Match
123ABC4567	Match
1234567ABC	Match
CBA	Unmatch
AB	Unmatch
BCDEF	Unmatch
AB1CDEFG	Unmatch
12345AB	Unmatch

The writing in **blue** is a partial match to the Master data

4.2.6 Command alias

Command alias can register [Start Reading] and [Stop Reading] to other command character strings.

Registered Command Character string is called an Alias.



For details on various settings of the command alias function, refer to [\[4.6 Configuration Item Table\]](#) on page 4-54 for details.

Registering an Alias

Command controls [Start Reading] and [Stop Reading] can register up to 4 alias's each. Alias's can be registered using set up commands.

The maximum number of characters in a command character string is 16 characters (including prefix and suffix).

e.g. Registering an Alias with the following parameters.

Number of characters→	0	1	2	3	4	5	6	7	8	9	10	11	12	13	14	15
Start Reading																
Alias 0	STX	S	T	A	R	T	ETX									
Alias 1	o	n	CR													
Alias 2	ESC	R	E	A	D	CR	LF									
Alias 3	s	c	a	n												
Stop Reading																
Alias 0	STX	S	T	O	P	ETX										
Alias 1	o	f	f	CR												
Alias 2	ESC	C	A	N	C	E	L	CR	LF							
Alias 3	h	a	l	t												

At read start, each of the 5 commands including the original can be executed.

- Original Command : \wedge get **CR** **LF**
- Alias0 : **STX** START **ETX**
- Alias1 : on **CR**
- Alias2 : **ESC** READ **CR**
- Alias3 : scan

Stop Reading can execute each of the following five commands including the original.

- Original Command : \wedge stop **CR** **LF**
- Alias0 : **STX** **STOP** **ETX**
- Alias1 : off **CR**
- Alias2 : **ESC** **CANCEL** **CR** **LF**
- Alias3 : **halt**



You can change the control command "Start Reading" and "Stop Reading" according to the command system on the system or host device already in operation.



Any arbitrary character string can be set as an alias but command transmission and reception may not be performed correctly if the alias is identical to another existing communication command, partially matches another communication command, it is extremely short.
Register a character string only after confirming normal operation.

4.2.7 Communication command

Communication command transmits/receives various types of data from the host device connected via the WB2F's communication interface. The applications required to transmit/receive data are collectively called [communication command]



For details of various settings of the communication command function, refer to  [4.6 Configuration Item Table] on page 4-54 for details.

Communication Commands are composed of both Control Commands and Setup Commands

■ Control Command

Command to directly start up the WB2F. It can also execute other actions such as Symbol Reading, the Status LED ON/OFF etc.

■ Setup Command

This command can be used to change or acquire the WB2F's parameter settings such as RS-232 communications, the Status LED patterns, times etc.

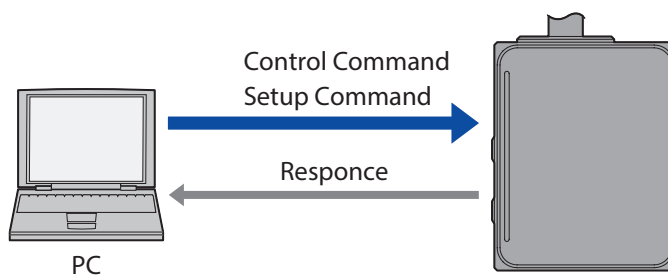

Communication Data Format: Regarding Prefix and Suffix

- Excluding prefix and suffix, communication data formats of communication commands are text (ASCII format)
- Based on usage environment, prefix and suffix can be changed
- This section is written assuming that the scanner has maintained its factory default settings



Notes on Communication

- Enter [prefix + suffix] if you suspect any of the following: the scanner is unused despite the power being on for a long period of time, the scanner appears to be receiving noise, or the scanner may be storing unnecessary data in its reception buffer. This will clear the reception buffer.
- The transmission and receive buffers have 16kB of storage. If data that exceeds 16kB is stored, data transmission and reception will not be correctly performed. If you plan on enabling the RS-232 interface's hardware flow control, keep the storage limitation in mind.

● Control Command

By inputting control commands from the host device into the WB2F, you can control the WB2F.
Control command output format examples are as follows:

e.g. Transmitting Control Command [Status LED (Red) ON]

- Request (Host Device → WB2F)

Prefix	Mnemonic	Suffix
^	leda1	CR LF

- Response (WB2F → Host device)

Normal Response

Prefix	Judge	Suffix
^	OK-00	CR LF

Abnormal Response

Prefix	Judge	Suffix
^	NG-ff	CR LF



- If an issue, such as the wrong command is input, occurs the response will become abnormal.
- For other commands, refer to [\[5. 6 List of Control Commands\]](#) on [page 5-13](#).
- You can add a check digit to Control Command responses.
- Response time of command control's (excluding [temporary image memory initialization], [non-volatile memory initialization], [save setting values], [set initial values]) is within 1s. Excluded command control response times are as follows; [Temporary image memory initialization] is within 5s, [non-volatile memory initialization] within 30s, [save setting values] within 5s and [set initial values] within 20s.

● Setup Command

By inputting setup commands from the host device into the WB2F, you can change/view setting parameter values. Control Command output format is as follows.

e.g. Obtain the settings for Address 0157 "Status LED (Red) Illumination Time".

• Request (Host Device → WB2F)

Prefix	Mnemonic	Address	Data Type	Suffix
^	g	0157	x	CR LF

• Response(WB2F → Host device)

Normal Response

Prefix	Mnemonic	Address	Data Type	Data	Suffix
^	g	0157	x	1e	CR LF

Abnormal Response

Prefix	Judge	Suffix
^	NG-ff	CR LF

e.g. Change the settings for Address 0157 "Status LED (Red) Illumination Time".

Request (Host device → WB2F)

Prefix	Mnemonic	Address	Data Type	Data	Suffix
^	s	0157	x	3c	CR LF

• Response(WB2F → Host device)

Normal Response

Prefix	Judge	Suffix
^	OK-00	CR LF

Abnormal Response

Prefix	Judge	Suffix
^	NG-ff	CR LF



- If an issue, such as the wrong command is input, occurs the response will become abnormal.
- Address Range is 0000H-FFFFH (16bit, hex).
- Data Range is 00H-FFH (8bit, hex).
- Address at the time of request can be either lowercase or uppercase.
- Response address will be in lower case (default) but can be changed to uppercase.
- You can add a check digit to set up command requests and responses.
- For other settings, refer to [\[4.6 Configuration Item Table\]](#) on page 4-54.
- Setup Command Response time is within 1s.

4.2.8 Parameter Changeover

The Read Parameter Changeover switches the read parameter tables of conditions such as image acquisition and decode. The save destination of the setting values of this function are called [read parameter table] and a maximum of 8 can be registered.

The following items can be configured in the read parameter table

Configuration Item	Details
Gain	Can configure analog/digital gain
Exposure Time	Exposure time can be configured
Decode Range	Configures a symbol's reading range
White Black Reversal Settings	Sets the number of read request symbols
Decoder Mode	Configure the decode algorithm
Image Filter	You can set the image filter
Read allowed/prohibited	Can set Read Allowed/Prohibited permission for each symbol

For details on the Read Parameter Changeover function and its various settings, refer to [\[Reading Parameter Changeover Function\]](#) on page 4-61

•Decode Range

Decode Range is defined as follows:

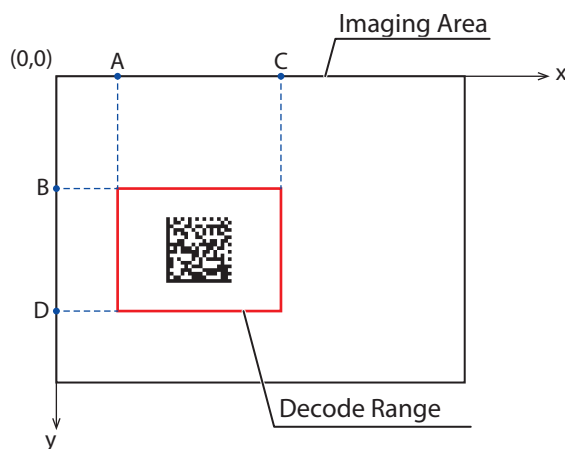

A: X Start coordinates
B: Y Start Coordinates
C: X End Coordinates
D: Y End Coordinates



Read response rates can be increased by narrowing the decode range.



Configure Decode Range more than the size of the symbol including quiet zone.
But when it is not possible to read, extend Decode Range.

•White Black Reversal Read

White and black reversal symbol is defined as the following



Normal usage





Reversal

● Read Parameter Table Changeover

There are two types of methods for switching read parameter tables.

For details on the read parameter table changeover function and its various settings please refer to  [Symbol Reading] on page 4-58.

- Table Specification Mode..... Page 4-32
- Sequence Mode..... Page 4-32
- Read Success Sort Page 4-33

Specify Table mode

Specify the read parameter table to commence reading.

When using the specified mode, set the [read parameter table specification] to "00-07.

e.g. If [Read parameter table specification] is set to "00", reading will be performed using only operation read parameter table 0.

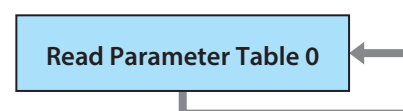

Sequence Mode

Will switch Read Parameter tables and begin reading in accordance to the sequence table settings.

The [sequence table] is defined as the execution order for setting destinations in the read parameter table. A maximum of 32 can be registered.

Prior to using sequence mode, set the value for "read parameter table" to "FF".

e.g. Operation given the following:

Read Parameter Table Specification:	FFH
Sequence Table Number:	03H
Read Success Sort:	Disabled
Sequence Table00:	02H
Sequence Table01:	01H
Sequence Table02:	05H

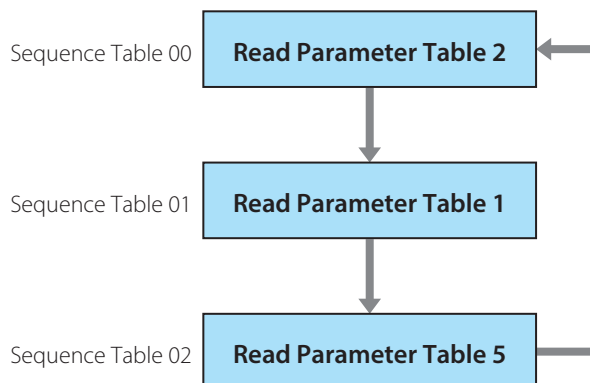

Reading Success Sort

Prior to the next read, the successfully read parameter table will be sorted at the beginning of the sequence table. If using Read Success sort, ensure that the setting for [read success sort] is enabled.

e.g. Operation given the following:

Read Parameter Table Specification : FFH
 Sequence Table Number : 03H
 Read Success Sort : Enabled
 Sequence Table00 : 02H
 Sequence Table01 : 01H
 Sequence Table02 : 05H

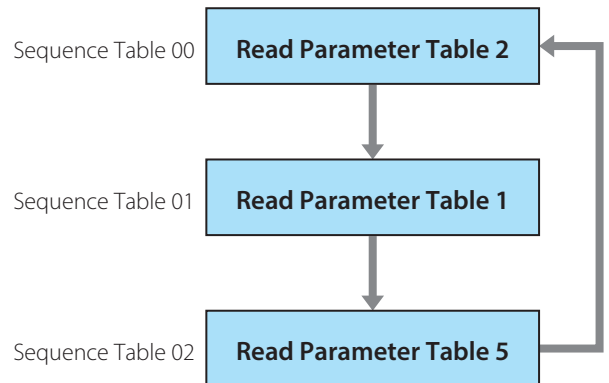

• First Reading Operation

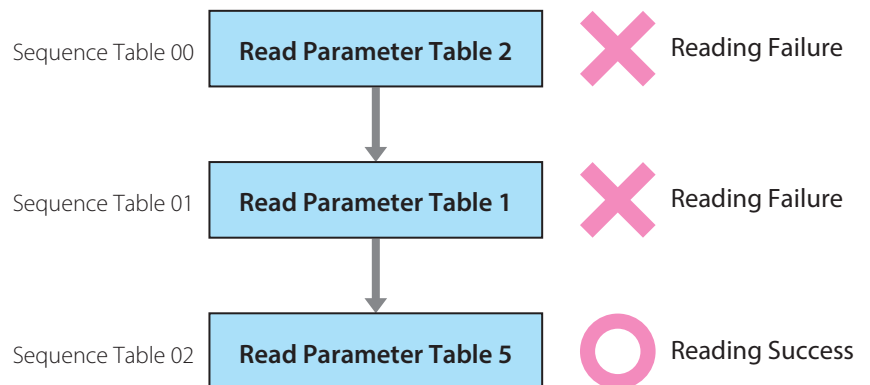

• Next Reading Operation

Last Reading Success Table
 Sort first

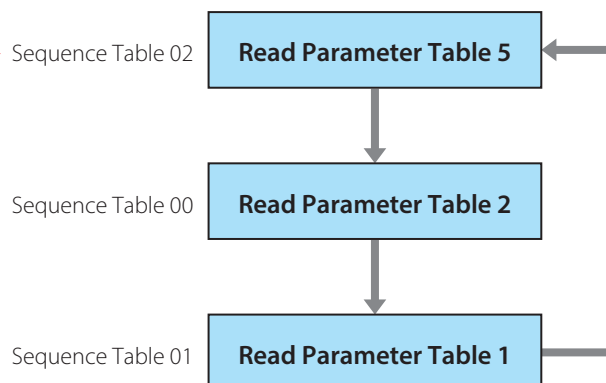

4.2.9 Image Capture

The settings for acquiring and storing images can be configured.

Host devices connected to the WB2F's communication interface are able to acquire saved images at arbitrary timing.

● Settings during image acquisition

The following items can be configured as settings for the image capture function.

Imaging size

Specify a valid imaging area in the imaging field of view.

Settings	Number of pixels (width x height)
Quad VGA	1280x960
720P	1280x720
WVGA	800x480

Field of view (height)

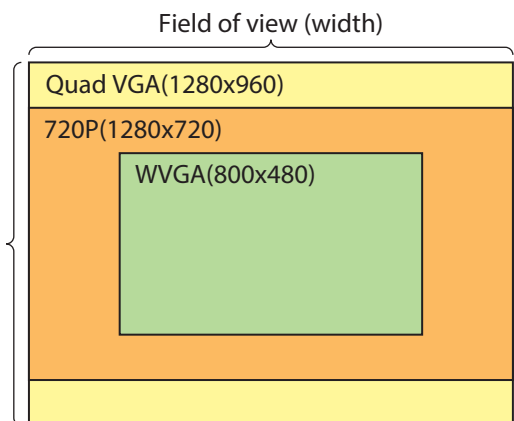

If you select anything but Quad VGA, your image acquisition FOV and your reading range will narrow.



- Read response rates can be increased by narrowing the field of view.
- The position of the imaging field of view when 720P, WVGA is selected is the center.

Image quality

Specify the density of the captured image.

Settings
High density
Low Density (1/2)

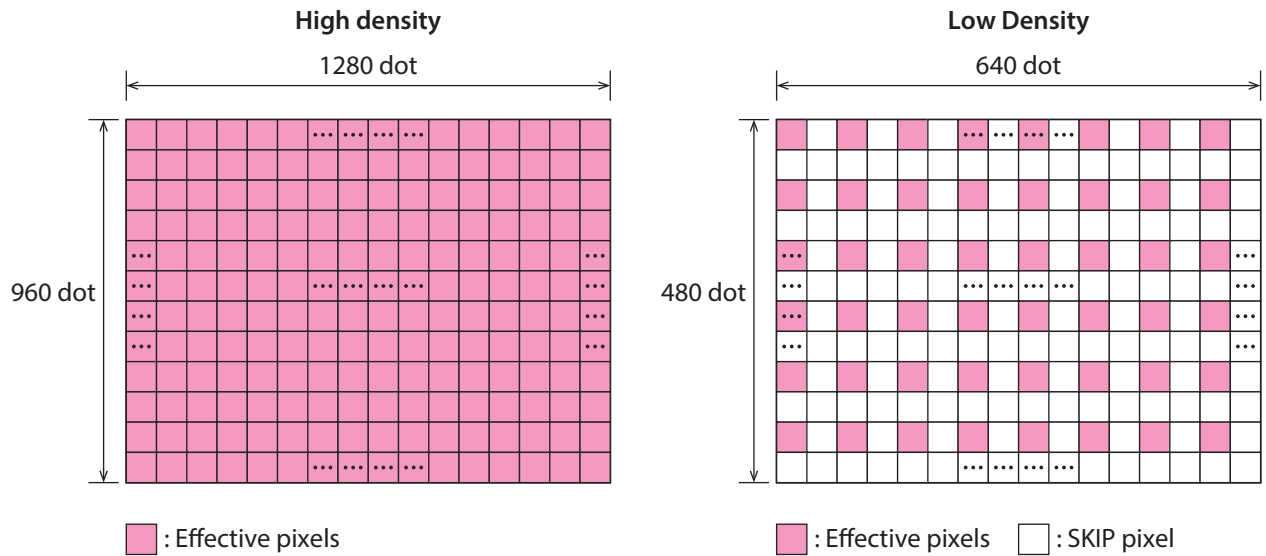

- By raising density settings, the scanner will be able to read more detailed symbols from a greater distance.
- Response rates can be increased by lowering density settings.

● On keeping acquired images

The WB2F has three types of image storage areas that each have different restrictions (such as in the number of images that can be saved).

Region	Number of saved images	Saved Image	Saved format	Update Timing
Imaging memory	1 sheet	Latest decoded image	BITMAP	when imaging is completed
Temporary image Memory	Max 16 sheets	Read Success image Read Fail image	BITMAP	Decode Completion Time
Non-volatile image memory	Max 128 sheets	Read Success image Read Fail image	JPEG	



- Refer to "Image Capture Function" in [\[4. 6 Configuration Item Table\]](#) on page 4-54 for more details on the image capture function and its various settings.
- Refer to [\[5. 6 List of Control Commands\]](#) on page 5-13 for details on control commands that can be used with the image capture function.
- Images can be acquired in three areas.



- During power OFF or the control command [Reset], Imaging memory and temporary image memory are discarded.
- Utilizing the image capture function will slow read response times compared to when the function is not used.
- If the device is powered OFF or the control command [Reset] is entered during image saving, the image will not be properly stored.
- We recommend that user's use the maintenance port when acquiring images from the host device as transmission data can be extremely large.
- There is a memory limit for image storage. If the scanner runs out of available space, no new images can be stored until the corresponding areas are reinitialized.

Acquiring and Saving Images

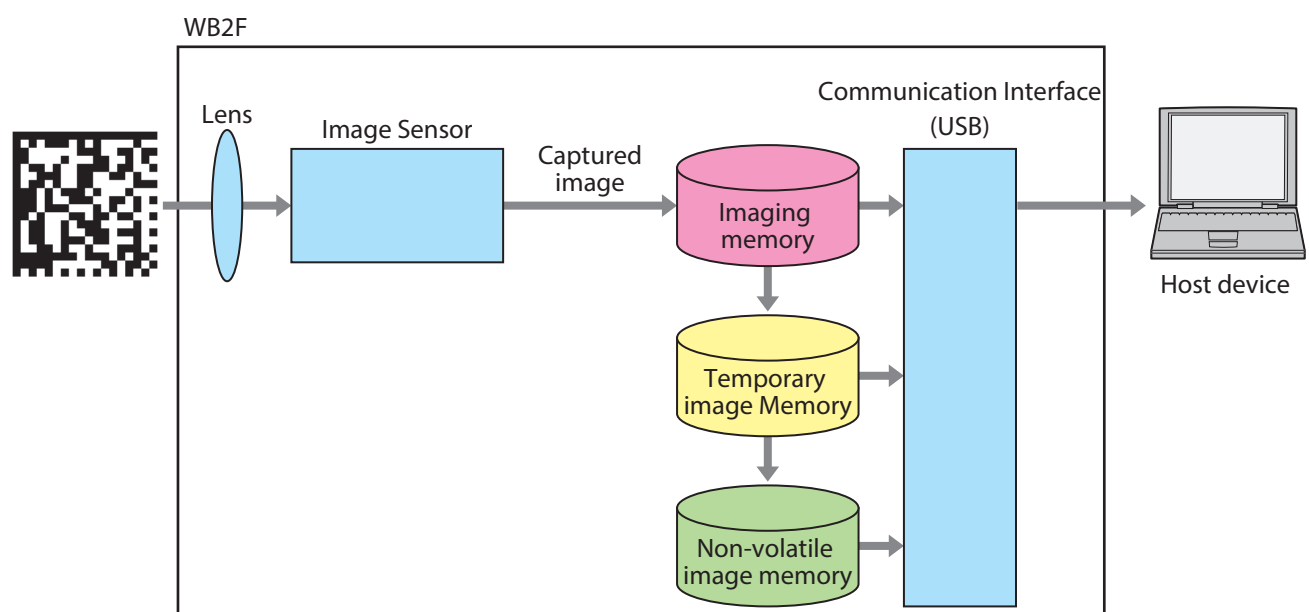

4.2.10 Image Filter

The image filter digitally corrects the acquired image.

There is a total of 7 image filters and up to 4 can be set up in combination.

For more details on the image filter function and its various settings refer to [\[Reading Parameter Changeover Function\]](#) on page 4-61.



When using filter, the noise is emphasized in the left, right, up or down as edge of captured image. Place symbol on the center of imaging view.

•Erode (Compression)

Expands the black while erasing minute traces of white.

Effective for black dot symbols and symbols with fine white blemishes.

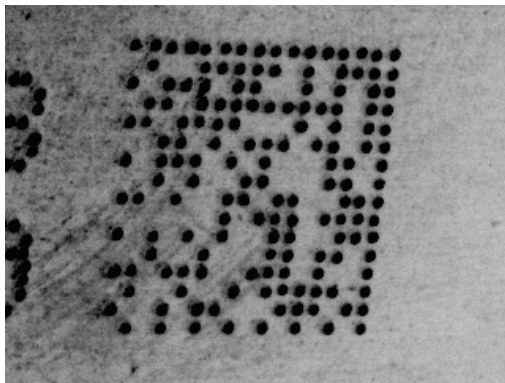

Before processing

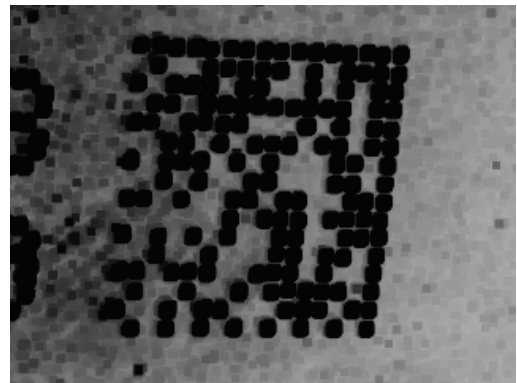

After processing

•Dilate (Expansion)

Expands the white areas while erasing minute traces of black.

Effective for white dot symbols and symbols with fine black blemishes.

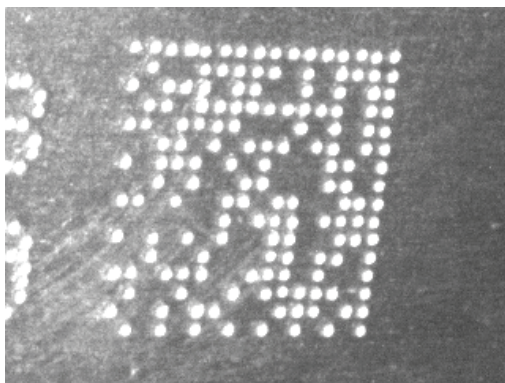

Before processing

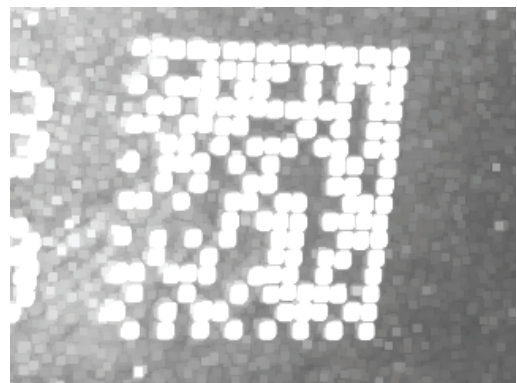

After processing

•Open

Dilate (Expansion) is performed after Erode (compression). The function will delete minute traces of white without expanding the black areas.

Effective for black symbols with fine white blemishes.

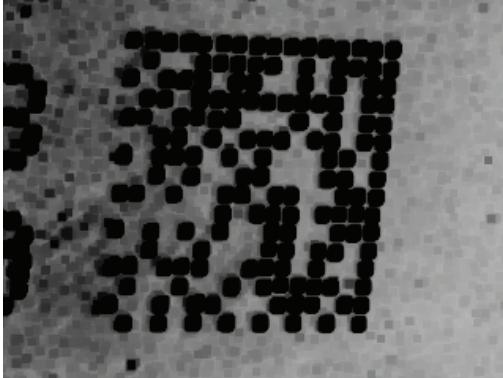

Before processing

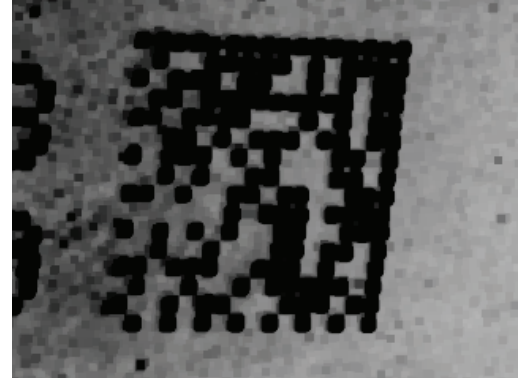

After processing

•Close

Erode (compression) is performed after Dilate (Expansion). The function will delete minute traces of black without expanding the white areas.

Effective for white symbols with fine black blemishes.

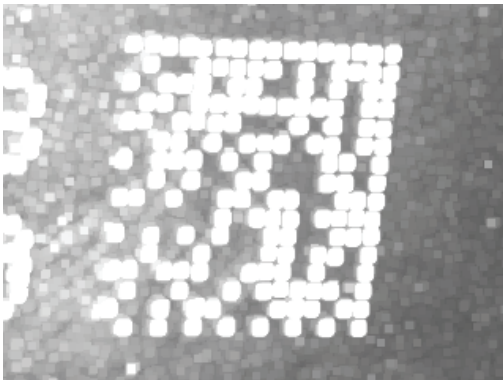

Before processing

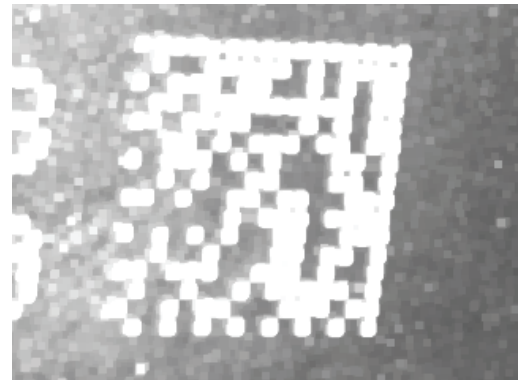

After processing

•Histogram Equalization(averaging)

Correct the brightness of the image so that the histogram of the image's brightness becomes uniform.

Effective in cases when the captured image is low contrast.



Before processing



After processing

•Sharpening

Sharpen the captured image.

Effective in cases when the captured image is low contrast or out of focus.



Before processing

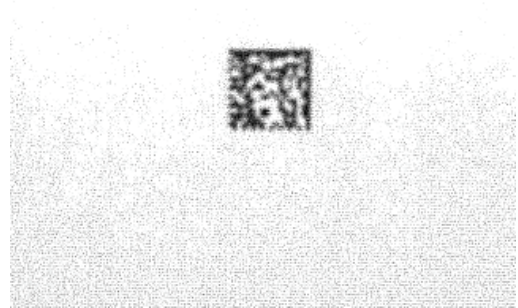

After processing

•Smoothing

Smooth out the captured image.

Effective for images with a lot of noise or symbols with white or black blemishes.

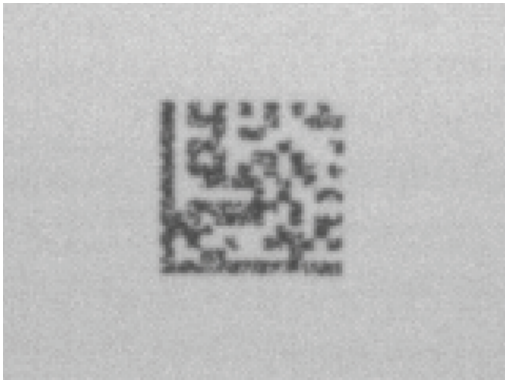

Before processing

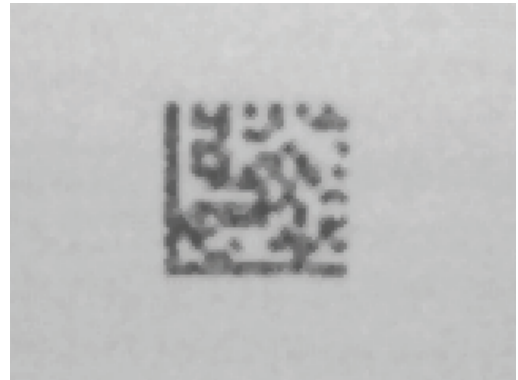

After processing

4.2.11 I/O

I/O is to operate and to get current status of the WB2F by using external output and the external input. There are 4 external outputs and 2 external inputs.

External Output

External Output has the following functions.

Terminal No.	Function	Operation
OUT0	OK Output	During Reading Success, Output turns ON.
OUT1	NG Output	During Reading Failure Output turns ON.
OUT2	BUSY Output	During Symbol Reading, Output will turn ON.
OUT3	Flash Output	Output turns on synchronously in time with flash output exposure time.



- Refer to "External Output Configuration" in  [4.6 Configuration Item Table] on page 4-54 for further details on I/O function and their various settings.
- OUT0 to OUT3 can be disabled through settings



Function of the external output differs based on its terminal No.

External Input

External Input has the following functions.

Terminal No.	Function	Operation
IN0	Start Reading	Starts symbol reading.
IN1	Stop Reading	Stops symbol reading.







- Refer to "External Output Configuration" in  [4.6 Configuration Item Table] on page 4-54 for further details on I/O function and their various settings.
- IN0 and IN1 functions can be disabled through settings.
- Stop Reading only operates with Edge Activation.



The function of the external input differs based on its terminal No.

4.3 Setup support mode

This mode is used to check the installation position and reading status of the WB2F. Setup support mode has the following function.

- Reading Success Rate Measurement..... Page 4-44
- Decoding Processing Time Measurement..... Page 4-45
- Symbol Placement Measurement..... Page 4-46
- Auto-Tuning..... Page 4-48

4.3.1 Switching operation to setup support mode

There are two methods to switch to setup support mode. Use the methods according to the situation.

Method 1 You can switch to setup support mode with the Operation button.
For details, refer to  [Detailed procedure using the READ/ENTER and SELECT buttons] on page 4-42.

Method 2 You can switch to setup support mode with control commands.
For detail, refer to  [5.6 List of Control Commands] on page 5-13.

● Detailed procedure using the READ/ENTER and SELECT buttons

- 1 When the unit's power supply is on, push the READ/ENTER button for 5 seconds.

The Status LEDs (green/orange/red) will flash and the unit will switch to the waiting state for measurement item to be selected in setup support mode.

 If 5 seconds elapse with no operation, the unit returns to the same operation mode as before you switch.

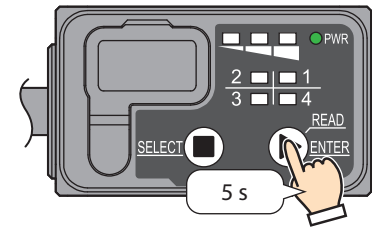

Status LEDs

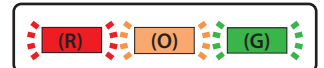

Wait for measurement item to be selected.

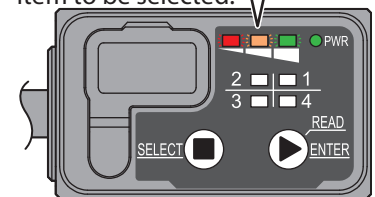

- 2 Push the SELECT button.

The Status LED (green) will flash and the unit will switch to the waiting state for Reading Success Rate measurement to be executed.

Status LEDs

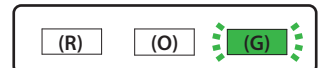

Wait for Reading Success Rate measurement to be executed.

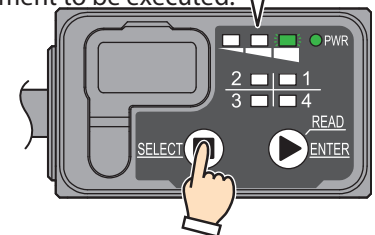

Status LEDs

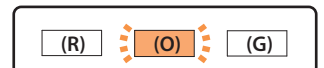

Wait for Decoding Processing Time measurement function to be executed.

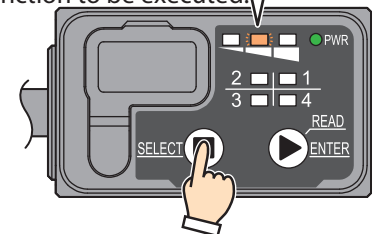

Status LEDs

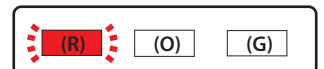

Wait for Symbol Position measurement function to be executed.

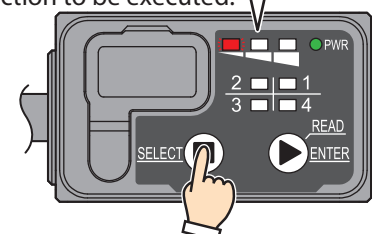

To select the Decoding Processing Time measurement, push the SELECT button.

The Status LED (orange) will flash prior to the decode processing measurement time switching to standby.

To select the Symbol Position measurement, push the SELECT button.

The status LED (red) will flash prior to the Symbol Position measurement function switching to standby.

To select Standard tuning, push the SELECT button.
Position LED 2 will flash prior to Standard tuning switching to standby mode.

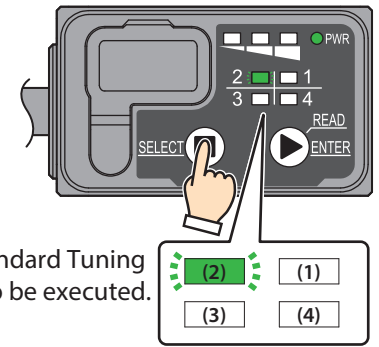

Position LEDs

To select Detailed tuning, push the SELECT button.
Position LED 1 will flash prior to Detail Tuning switching to standby mode.

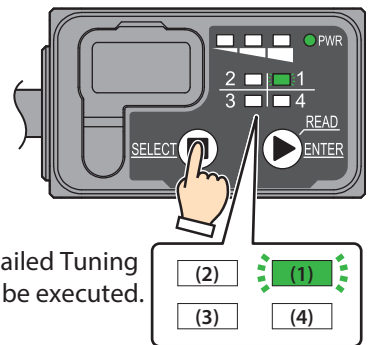

Position LEDs

To select Custom Tuning, push the SELECT button.
Position LED 3 will flash prior to custom tuning switching to standby mode.

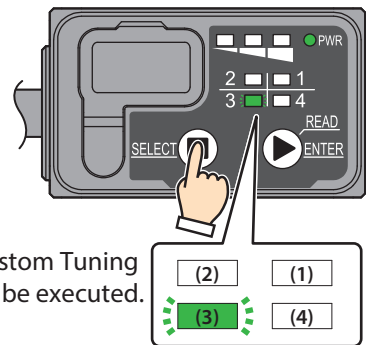

Position LEDs



- When the SELECT button is pushed while LED 3 is blinking, the status LED (green) will flash, and the Reading Success Rate measurement will changeover to execution standby mode.
- If 5 seconds elapse with no operation, the WB2F will revert to the operation mode it was in prior to switching.

3 Measurement begins once READ/ENTER button is pushed.

4 If READ/ENTER button is pushed again, Measurement will stop

Once complete, the unit will revert back to its operation mode prior to switching.

Measurement Start/ Measurement Finish

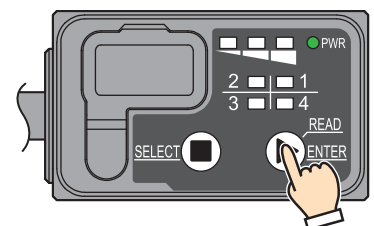

4.3.2 Reading Success Rate Measurement

Reading Success Rate is output for every 10 symbols read.

The measurement results can be checked with the communication interface and the Status LEDs.

An example of the measurement results output format is as follows.

Rate:[Reading success rate]:Code:[Read Data] **CR** **LF**

* At this time, the global prefix is fixed as "none" and the global suffix is fixed as "**CR** **LF**".

e.g. If read data is "490123456789" Reading Success Rate is 100%.

Rate:100%: Code:4901234567894 **CR** **LF**

The status LED indicates the Reading Success Rate.

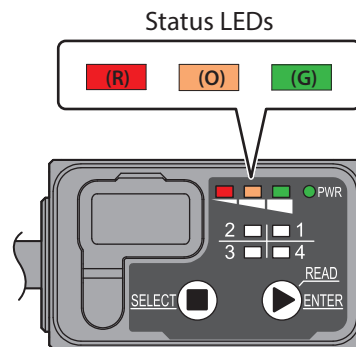

The operation of the Status LEDs is as follows.

Reading Success Rate	0%	10%	20-30%	40-50%	60-70%	80-90%	100%
LED(Green)	(G)	(G)	(G)	(G)	(G)	(G)	(G)
LED(Orange)	(O)	(O)	(O)	(O)	(O)	(O)	(O)
LED(Red)	(R)	(R)	(R)	(R)	(R)	(R)	(R)



- At the start of the measurement, the "*** Reading Rate ***" **CR** **LF** message is output to the communication interface.
- To stop the measurement, push the READ/ENTER button or input the communication command suffix. (The initial value is **CR** **LF**)
- When ended, the WB2F returns to the operation mode before the switch.

4.3.3 Decoding Processing Time Measurement

Outputs min/max and average Decoding Processing Time for every 10 symbols read.

The measurement results can be checked with the communication interface and the Status LEDs.
An example of the measurement results output format is as follows.

Min: [minimum Decoding Processing Time (ms)] Max: [maximum Decoding Processing Time (ms)] Ave: [Average Decoding Processing Time (ms)] Code:[Read Data] CR LF

* At this time, the global prefix is fixed as "none" and the global suffix is fixed as "CR LF".

e.g. If minimum Decoding Processing Time is "140", maximum Decoding Processing Time is "252", average Decoding Processing Time is "206" and read data is "IDEC AUTO-ID".

Min:0148 Max:0252 Ave:0206 Code:IDEC Auto-ID CR LF

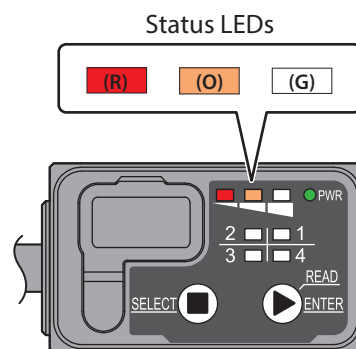

The operation of the Status LEDs is as follows.

Decoding Processing Time (Average)	Unreadable	Over 501 ms	401-500ms	301-400ms	201-300ms	101-200ms	Under 100ms
LED(Green)	(G)	(G)	(G)	(G)	(G)	(G)	(G)
LED(Orange)	(O)	(O)	(O)	(O)	(O)	(O)	(O)
LED(Red)	(R)	(R)	(R)	(R)	(R)	(R)	(R)



- At the start of the measurement, the "*** Decoding Time *** CR LF" message is output to the communication interface.
- To stop the measurement, push the READ/ENTER button or input the communication command suffix. (The initial value is CR LF)
- When ended, the WB2F returns to the operation mode before the switch.

4.3.4 Symbol Position Measurement

Will read a symbol and output code location information.
The quiet zone is not included in position information.

The measurement results can be checked with the communication interface and the Position LEDs.
Measurement result output is as follows.

(x1,y1)(x2,y2)(x3,y3)(x4,y4) [Position Display LED Status] Code:[Read Result Data] CR LF

*1 (x1, y1) to (x4, y4) : Symbol vertex coordinates

*2 At this time, the global prefix is fixed as "none" and the global suffix is fixed as "CR LF".

Coordinates are defined as follows.

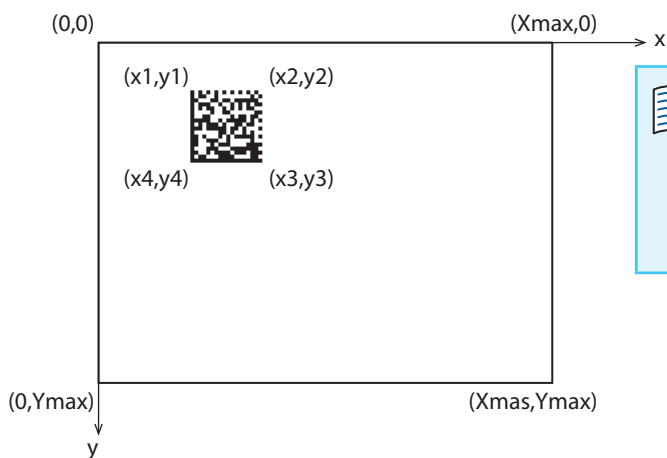

- Xmax, Ymax will vary depending on settings.
- For more details on vertex coordinates (x1, y1) refer to [\[5. 13 Sample labels\]](#) on page 5-28.

Coordinate output order will differ based on symbol orientation.



e.g. If Position Information is "(x1,y1)(x2,y2)(x3,y3)(x4,y4)=(0451,0166)(0742,0171)(0740,0450)(0438,0446)", and Read data is "IDEC Auto-ID".

(0451,0166)(0742,0171)(0740,0450)(0438,0446) 12-- Code:IDEC Auto-ID CR LF

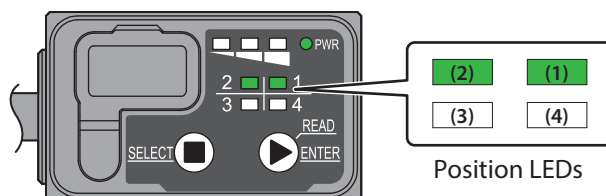



- At the start of the measurement, the "*** Label Position *** CR LF" message is output to the communication interface.
- To stop the measurement, push the READ/ENTER button or input the communication command suffix. (The initial value is CR LF).
- When ended, the WB2F returns to the operation mode before the switch.

● The relationship between Symbol placement and the Position LED

An imaging view is divided to 4 areas as the following figure. A.

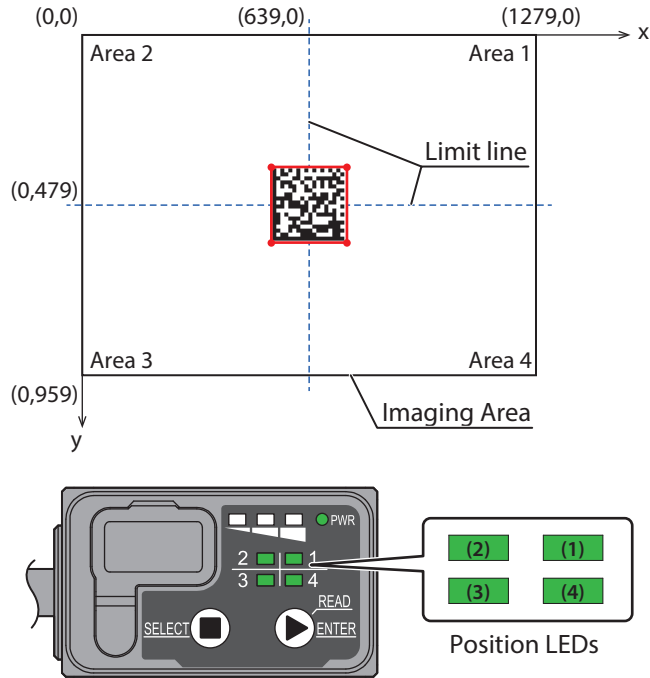
The position LED will be flashed with a climax coordinate of the symbol range which succeeded to decode (in red with line).



 If the coordinates overlap on the limit line, the right and lower areas will be prioritized.

An example of the relationship between symbol position and the position LED is as follows.

Symbol position				
Position LED	(2) (1) (3) (4)	(2) (1) (3) (4)	(2) (1) (3) (4)	(2) (1) (3) (4)
Symbol position				
Position LED	(2) (1) (3) (4)	(2) (1) (3) (4)	(2) (1) (3) (4)	(2) (1) (3) (4)
Symbol position				
Position LED	(2) (1) (3) (4)	(2) (1) (3) (4)	(2) (1) (3) (4)	(2) (1) (3) (4)

4.3.5 Autotuning

The auto-tuning automatically adjusts parameters to optimize symbol reading performance and saves those values to a read parameter table.

There are three types of auto-tuning.

For more details on the auto-tuning and its various settings, refer to  "Auto-tuning" in [4.6 Configuration Item Table] on page 4-54.

Standard tuning

Tuning that is specialized for easy to read symbols (such as those printed on paper). Use this setting for standard operations.

Detailed Tuning

Will perform auto-tuning that is specialized for difficult symbols (such as DPM). Use this function when standard tuning has failed.

* It may take up to several minutes for tuning to complete as the WB2F searches for the optimum image filter.

Custom tuning

This function is adjusting value of the auto configuration after confured value of the auto configuration.

Use confuring value of the auto configuration when you would like to change the value of the auto configuration.

Auto-tuning setting values are as follows.

Configuration Item	Standard	Details	Custom
Read parameter table registration destination number	Can be set arbitrarily		Can be set arbitrarily
Tuning mode	High speed mode		
Exposure time limit value	Without restriction		
Symbol Registration	Register only tuned symbols		
White and black reversal symbol reading	Auto		
Image Filter	Do Not Use	Use	
Imaging parameters	Prioritize Distance	Prioritize readability	
Decode Parameter	Prioritize Stability	Prioritize reading performance	
Read Timeout Time	10s		
Compatible Symbol	All symbols	Data Matrix, QR Code, Micro QR Code	

The results of auto-tuning can be conveyed either via the communication interface or the Status LEDs
The resulting output form is the following.

NOW [Tuning Name]...

TableSetting

TableNum:[Reading parameter table registration destination number]

Analog Gain: [Analog gain setting value]:([Scale factor])

Digital Gain: [Digital Gain Setting Value]:([scale factor])

Exposure Time: [Exposure Time Setting Value]:([setting time (us)])

WhiteBlackReverse: [white black reverse read setting value]:([setting details])

DecodeMode:[Decode Mode]

Filter1:[image filter setting value(1st time)]:([filter name])

Filter2:[image filter setting value(2nd time)]:([filter name])

Filter3:[image filter setting value(3rd time)]:([filter name])

Filter4:[image filter setting value(4th time)]:([filter name])

EnableSymbol:[Readable Code Name]

DecoderSetting

[Decoder Set up altem]:[setting details]

DecodeResult

DecodeLevel:[Symbol readability (0-100)]

DecodeTime(ms):[Decode Processing time]

ProcessingTime(s):[Auto-tuning processing time]





Only outputs if there is a change.

The operation of the Status LEDs is as follows.

Auto-tuning operation status	Auto-tuning running	Auto-tuning complete (success)	Auto-tuning complete (failure)
Status LED (Green)	<input type="button" value="(G)"/>	<input type="button" value="(G)"/>	<input type="button" value="(G)"/>
Status LED (Orange)	<input type="button" value="(O)"/>	<input type="button" value="(O)"/>	<input type="button" value="(O)"/>
Status LED (Red)	<input type="button" value="(R)"/>	<input type="button" value="(R)"/>	<input type="button" value="(R)"/>

4.4 Maintenance mode

This mode is used for maintenance during operation after WB2F installation and to perform actions when problems occur. Maintenance mode has the following functions.

- Maintenance Support  Page 4-52
- Firmware updating.....  Page 4-52

4.4.1 Switching operation to maintenance mode

There are two methods to switch to maintenance mode.

Use the methods depending on maintenance and the situation when a problem occurs.

The STUATUS LEDs (red/orange/green) will all flash (2 seconds on, 2 seconds off) when switching to maintenance mode.

Method 1 You can switch to maintenance mode with the READ/ENTER button.
For details, refer to  [Detailed procedure using the READ/ENTER button] on page 4-51.

Method 2 Input the "switch to maintenance mode" control command.
For details, refer to  [5.6 List of Control Commands] on page 5-13.

● Detailed procedure using the READ/ENTER button

- 1 Turn on the power to the unit while pushing the READ/ENTER button.

(2) Turn on power supply

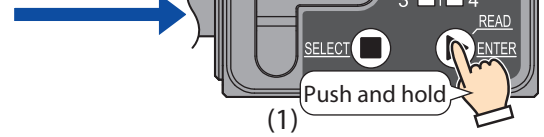

- 2 Put the READ/ENTER button ON until you can confirm the Status LEDs (green/orange/red) have flashed. (Approximately 5 seconds or longer)

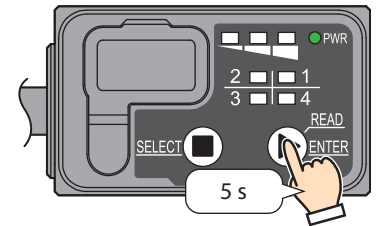

The Status LEDs (green/orange/red) will all flash (2 seconds on, 2 seconds off) and the WB2F switches to maintenance mode.

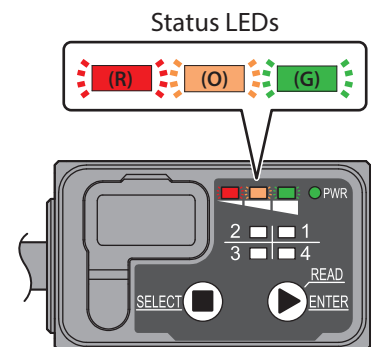

4.4.2 Maintenance support

This function temporarily operates the WB2F with the factory default settings when problems occur such as symbols can no longer be read or communication is no longer possible with the host device after changing the WB2F settings. This function can be executed by switching to maintenance mode.



- The setting values are restored by turning the power on/off, resetting, or switching the mode.
- When a symbol is read, the flashing LEDs (green/orange/red) turn off. The LEDs (green/orange/red) will flash again after 5 seconds.
- After switching to maintenance mode, you can restore the setting values to the factory defaults by reading the initialization barcode. For the initialization barcode, refer to  [Page 5-27](#).

4.4.3 Firmware updating

This function updates the WB2F firmware.



- New functions that are added to the firmware can be used by executing a firmware version upgrade.
- The latest firmware is available on the IDEC website. Check whether or not there is new firmware on the IDEC website.

4.5 Master Mode

Mode that specifies that the WB2F operates according to the communication protocol of the external device.

When operating in this mode, you cannot transmit/receive using the communication commands outlined on [Page 4-28](#).

4.5.1 Switching to Master Mode

Use the following method to switch the unit over to master mode.

The Status LED (Green) will flash for 2 seconds prior to the unit switching over to master mode.

Method After changing the external device connection function (PLC)'s [function enabled] to enable, save the change and restart the Unit.

For details, refer to Master Mode transition by changing settings.

● Master Mode transition by changing settings

- 1 Changes [Enabling PLC connection function] setting value to "01H"
- 2 Executes Control Command [Save Setting Values]
- 3 Turns power OFF and then ON

The WB2F will switch to master mode after the status LED (green) flashes for 2 seconds and all the status LED lights (green/orange/red) turn off.

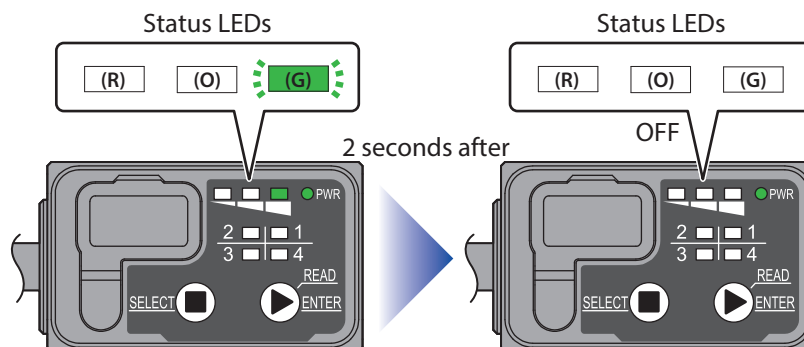

4.5.2 Connecting to a PLC

PLC connect function is which writes a reading data of the symbol into a memory of PLC (programmable logic controller) directly.

Because the WB2F is compatible with the PLC's communication protocol, there is no need to create a special communication program for the PLC.

Please download "WB2F 2D Code Scanner PLC Connect function user's manual (B-1959)" from our Web site about PLC connect function in detail.

4.6 Configuration Item Table

The settings and setting values that define the manner in which the WB2F operates are as follows.

You can define the customized operation of the WB2F for your environment by changing the setting values.



- When setting values are changed, the setting values must be saved with the "save setting values" control command.
- If the power is turned off, the unit is reset, or the operation mode is changed without executing "save setting values", the setting values are restored to the same values as before they are changed.
- Do not access or change any settings that are not listed here.
- Do not access or change any settings in reserved areas.
- Do not access or change any settings during a reading operation.



When configuring settings that specify ASCII code for the setting value, be aware of the following points.

- **NUL** (00H) cannot be used as a setting value.
- The characters up to the first **NUL** (00H) are considered the data and any data after that is not valid.

Setting value (hex) of bold face is default value (Setting at the time of factory shipments).

Item	Sub item	Address (hex)	Size (dec)	Default (hex)	Setting value (hex)	Remarks
Reserved		0000-01FF	256	-	-	
RS-232 settings	Communication speed	0100	1	03	00 : 1,200bps 01 : 2,400bps 02 : 4,800bps 03 : 9,600bps 04 : 19,200bps 05 : 38,400bps 06 : 57,600bps 07 : 115,200bps 0a : 600bps	After saved, the settings are reflected when the power is turned on, the WB2F is reset, or the operation mode is changed.
	Data length	0101	1	01	00 : 7bits 01 : 8bits	
	Parity	0102	1	01	00 : NONE 01 : EVEN 02 : ODD	
	Stop bits	0103	1	00	00 : 1bit 01 : 2bits	
	Flow control	0104	1	00	00 : None 01 : CTS/RTS	
	Reserved	0105-010F	11	-	-	
Reserved		0110-011F	16	-	-	
External Output settings	OUT0 Reading Linked Control	0120	1	01	00 : Disabled 01 : OK Output Enabled	Enable to link to the reading operation.
	Reserved	0121	1	-	-	

Item	Sub item	Address (hex)	Size (dec)	Default (hex)	Setting value (hex)	Remarks
External Output settings	OUT0 polarity	0122	1	01	00 : Positive Logic 01 : Negative logic	Positive Logic : As OUT0 is output, the transistor (open collector output) will turn OFF and become High state. Negative Logic : As OUT0 is output, the transistor (open collector output) will turn ON and become Low state. Setting values that are altered will immediately be reflected in output, even if during a reading operation.
	OUT0 duration	0123	1	0A	00 : Infinity 01 - FF : Setting value by 10ms step (10 ms to 2,550 ms)	
	OUT1 Reading Linked Control	0124	1	02	00 : Disabled 02 : NG Output Enabled	Enable to link to the reading operation.
	Reserved	0125	1	-	-	
	OUT1 Polarity	0126	1	01	00 : Positive Logic 01 : Negative logic	Positive Logic : As OUT1 is output, the transistor (open collector output) will turn OFF and become High state. Negative Logic : As OUT1 is output, the transistor (open collector output) will turn ON and become Low state. Setting values that are altered will immediately be reflected in output, even if during a reading operation.
	OUT1 duration	0127	1	0A	00 : Infinity 01 - FF : Setting value by 10ms step (10 ms to 2,550 ms)	
	OUT2 Reading Linked Control	0128	1	03	00 : Disabled 03 : BUSY Output Enabled	Enable to link to the reading operation.
	Reserved	0129	1	-	-	
	OUT2 polarity	012A	1	01	00 : Positive Logic 01 : Negative logic	Positive Logic : As OUT2 is output, the transistor (open collector output) will turn OFF and become High state. Negative Logic : As OUT2 is output, the transistor (open collector output) will turn ON and become Low state. Setting values that are altered will immediately be reflected in output, even if during a reading operation.
	OUT2 duration	012B	1	00	00 : Infinity 01 - FF : Setting value by 10ms step (10 ms to 2,550 ms)	
	OUT3 Reading Linked Control	012C	1	04	00 : Disabled 04 : FLASH Synchronous output Enabled	Enable to link to the reading operation.
	Reserved	012D	1	-	-	

Item	Sub item	Address (hex)	Size (dec)	Default (hex)	Setting value (hex)	Remarks
External Output settings	OUT3 polarity	012E	1	01	00 : Positive Logic 01 : Negative logic	Positive Logic : As OUT3 is output, the transistor (open collector output) will turn OFF and become High state. Negative Logic : As OUT3 is output, the transistor (open collector output) will turn ON and become Low state. Setting values that are altered will immediately be reflected in output, even if during a reading operation.
	Reserved	012F	1	-	-	
External Input settings	IN0 Control	0130	1	01	00 : Disabled 01 : Reading Start	
	IN0 active level	0131	1	01	00 : High 01 : Low	
	IN0 Filter time	0132	1	20	01 to 64 (1ms to 100ms)	Configured input signal works when IN0 stays ON for longer than set value. Do not set to small value of the Filter time, due to there is possibility to have an influence on noise tolerance.
	Reserved	0133	1	-	-	
	IN1 Control	0134	1	02	00 : Disabled 02 : Reading Stop	This setting is compatible with Single Read, edge activation only.
	IN1 active level	0135	1	01	00 : High 01 : Low	
	IN1 filter time	0136	1	20	01 to 64 (1ms to 100ms)	Configured input signal works when IN1 stays ON for longer than set value. Do not set to small value of the Filter time, due to there is possibility to have an influence on noise tolerance.
Reserved	0137-013F	9	-	-		
Reserved	0140-014F	16	-	-		

Item	Sub item	Address (hex)	Size (dec)	Default (hex)	Setting value (hex)	Remarks
Status LED settings	Status LED (green) reading linked control	0150	1	01	00 : Disabled 01 : Enabled	Enable to link to the reading operation.
	Reserved	0151	1	-	-	-
	Status LED (green) illumination pattern	0152	1	01	00 : OFF 01 : ON 02 : Flashing (high speed) 03 : Flashing (medium speed) 04 : Flashing (low speed)	
	Status LED (green) illumination time	0153	1	1E	00 : Infinity 01 - FF : Setting value by 10ms step (10 ms to 2,550 ms)	
	Status LED (red) reading linked control	0154	1	01	00 : Disabled 01 : Enabled	Enable to link to the reading operation.
	Reserved	0155	1	-	-	-
	Status LED (red) illumination pattern	0156	1	01	00 : OFF 01 : ON 02 : Flashing (high speed) 03 : Flashing (medium speed) 04 : Flashing (low speed)	
	Status LED (red) illumination time	0157	1	1E	00 : Infinity 01 - FF : Setting value by 10ms step (10 ms to 2,550 ms)	
	Status LED (orange) reading linked control	0158	1	01	00 : Disabled 01 : Enabled	Enable to link to the reading operation.
	Reserved	0159	1	-	-	-
	Status LED (orange) illumination pattern	015A	1	01	00 : OFF 01 : ON 02 : Flashing (high speed) 03 : Flashing (medium speed) 04 : Flashing (low speed)	
	Status LED (orange) illumination time	015B	1	00	00 : Infinity 01 - FF : Setting value by 10ms step (10 ms to 2,550 ms)	
	Reserved	015C	1	-	-	-
	Reserved	015D	1	-	-	-
	Reserved	015E	1	-	-	-
Reserved	015F	1	-	-	-	
Operation button settings	Reading start with READ/ENTER button	0160	1	01	00 : Disabled 01 : Enabled	Enable if you use the READ/ENTER button to execute Start Reading Request.
	Reserved	0161	1	-	-	-
	Reserved	0162	1	-	-	-
	Reserved	0163	1	-	-	-
	Reading stop with SELECT button	0164	1	01	00 : Disabled 01 : Enabled	Enable if you use the SELECT button to execute Stop Reading Request.
	Reserved	0165-016F	11	-	-	-
Reserved	0170-01FF	144	-	-	-	

Item	Sub item	Address (hex)	Size (dec)	Default (hex)	Setting value (hex)	Remarks
Symbol Reading	Symbol Reading	0200	1	00	00 : Single read 01 : Multi-Read sequential output 02 : Multi-Read batch output	
	Reading Timeout	0201	1	14	00 : Infinity 01 - FF : Setting value by 100ms step (100 ms to 25,500 ms)	Set the maximum time to continue the reading operation from the occurrence of a reading request. Set the setting value to infinity in the usage that the reading operation synchronizes with the external input or the start/stop symbol reading command.
	Preventing Double Read Time	0202	1	14	00 : None 01 - FF : Setting value by 100ms step (100 ms to 25,500 ms)	Sets the time that the same symbol will not be read when performing the Multi-Read.
	Reserved	0203	1	-	-	
	Reading start when power on	0204	1	00	00 : Disabled 01 : Enabled	If new settings are enabled, operations will commence in accordance to the new settings as soon as the WB2F is powered on or is switched to slave mode.
	Reserved	0205	1	-	-	
	Reserved	0206	1	-	-	
	Decode Timeout	0207	1	05	00 : None 01 - FF : Setting value by 100ms step (100 ms to 25,500 ms)	
	Reserved	0208-020D	6	-	-	
	Number of symbols read	020E	1	01	01 - 20 : Number of symbols to be read per image	Configures the Read Request Symbol Number.
	Output mode	020F	1	00	00 : Output 01 : Do not output	00 : Will output results even if Read Result is less than the number of Read symbols. As soon as Read Request is turned OFF, all results will be output. 01 : Will not output results if Read Result is less than the number of read symbols. As soon as Read Request is turned OFF, the Character String at the time of Read Failure will be output.
	Reading Result Output Port	0210	1	00	00 : RS-232 01 : USB	To configure the communication port to send the reading data when to request by operational button and external input. The configured communication port is not affected by request from RS-232 and Maintenance Port.
Reserved	0211-021F	15	-	-		

Item	Sub item	Address (hex)	Size (dec)	Default (hex)	Setting value (hex)	Remarks
Symbol Reading	Reading Parameter Table Specification	0220	1	00	00-07 : Table Specification Mode FF : Sequence Mode	
	Sequence Table Number	0221	1	01	01 - 20 : Number of Sequence Tables to be used	
	Reading Success Sort	0222	1	00	00 : Disabled 01 : Enabled	
	Reserved	0223	1	-	-	
	Sequence Table0	0224	1	00	00-07 : Parameter table number to be used	
	Sequence Table1	0225	1	01	00-07 : Parameter table number to be used	
	Sequence Table2	0226	1	02	00-07 : Parameter table number to be used	
	Sequence Table3	0227	1	03	00-07 : Parameter table number to be used	
	Sequence Table4	0228	1	04	00-07 : Parameter table number to be used	
	Sequence Table5	0229	1	05	00-07 : Parameter table number to be used	
	Sequence Table6	022A	1	06	00-07 : Parameter table number to be used	
	Sequence Table7	022B	1	07	00-07 : Parameter table number to be used	
	Sequence Table8	022C	1	00	00-07 : Parameter table number to be used	
	Sequence Table9	022D	1	01	00-07 : Parameter table number to be used	
	Sequence Table10	022E	1	02	00-07 : Parameter table number to be used	
	Sequence Table11	022F	1	03	00-07 : Parameter table number to be used	
	Sequence Table12	0230	1	04	00-07 : Parameter table number to be used	
	Sequence Table13	0231	1	05	00-07 : Parameter table number to be used	
	Sequence Table14	0232	1	06	00-07 : Parameter table number to be used	
	Sequence Table15	0233	1	07	00-07 : Parameter table number to be used	

Item	Sub item	Address (hex)	Size (dec)	Default (hex)	Setting value (hex)	Remarks
Symbol Reading	Sequence Table16	0234	1	00	00 - 07 : Parameter table number to be used	
	Sequence Table17	0235	1	01	00 - 07 : Parameter table number to be used	
	Sequence Table18	0236	1	02	00 - 07 : Parameter table number to be used	
	Sequence Table19	0237	1	03	00 - 07 : Parameter table number to be used	
	Sequence Table20	0238	1	04	00 - 07 : Parameter table number to be used	
	Sequence Table21	0239	1	05	00 - 07 : Parameter table number to be used	
	Sequence Table22	023A	1	06	00 - 07 : Parameter table number to be used	
	Sequence Table23	023B	1	07	00 - 07 : Parameter table number to be used	
	Sequence Table24	023C	1	00	00 - 07 : Parameter table number to be used	
	Sequence Table25	023D	1	01	00 - 07 : Parameter table number to be used	
	Sequence Table26	023E	1	02	00 - 07 : Parameter table number to be used	
	Sequence Table27	023F	1	03	00 - 07 : Parameter table number to be used	
	Sequence Table28	0240	1	04	00 - 07 : Parameter table number to be used	
	Sequence Table29	0241	1	05	00 - 07 : Parameter table number to be used	
	Sequence Table30	0242	1	06	00 - 07 : Parameter table number to be used	
	Sequence Table31	0243	1	07	00 - 07 : Parameter table number to be used	
	Reserved	0244-02FF	188	-	-	

Item	Sub item	Address (hex)	Size (dec)	Default (hex)	Setting value (hex)	Remarks
Reading Parameter Changeover Function Parameter Table0	Reserved	0300	1	-	-	
	Reserved	0301	1	-	-	
	Analog Gain	0302	1	02	01 : 1 Time 02 : 2 Times 04 : 4 Times 08 : 8 Times	
	Digital Gain	0303	1	20	01 - FF : Setting value by 0.03125 times step	
	Exposure Time	0304	2	33	0003 - 0168 : Setting value by 27.76us step(QuadVGA)	
		0305		00	Setting value by 30.00us step (Other Than QuadVGA)	
	Decode Range X Start Coordinates	0306	2	00	0000 - 04FF : X Start Coordinates	It is necessary for X Start<X end and Y Start<Y End. If the acquired image sizes are altered, the change will be automatically be reflected on all acquired image sizes.
		0307		00		
	Decode Range Y Start Coordinates	0308	2	00	0000 - 03BF : Y Start Coordinates	
		0309		00		
	Decode Range X End Coordinates	030A	2	FF	0000 - 04FF : X End Coordinates	
		030B		04		
	Decode Range Y End Coordinates	030C	2	BF	0000 - 03BF : Y End Coordinates	
		030D		03		
	White Black Reversal Settings	030E	1	00	00 : Normal Symbols only 01 : Normal symbols and reversed symbols 02 : Reversed symbols only	
	Decoder Mode	030F	1	04	01 : Level1 02 : Level2 03 : Level3 04 : Level4 05 : Level5	Reading performance will improve as the level is raised but decode processing time for each code will increase.
	Filter Setting 1st time	0310	1	00	00 : No Filter 01 : Erode (Compression) 02 : Dilate (Expansion) 03 : Open 04 : Close 05 : Histogram Equalization(Averaging) 06 : Sharpening 07 : Smoothing	
Filter Setting 2nd time	0311	1	00	00 : No Filter 01 : Erode (Compression) 02 : Dilate (Expansion) 03 : Open 04 : Close 05 : Histogram Equalization(Averaging) 06 : Sharpening 07 : Smoothing		
Filter Setting 3rd time	0312	1	00	00 : No Filter 01 : Erode (Compression) 02 : Dilate (Expansion) 03 : Open 04 : Close 05 : Histogram Equalization(Averaging) 06 : Sharpening 07 : Smoothing		

Item	Sub item	Address (hex)	Size (dec)	Default (hex)	Setting value (hex)	Remarks
Reading Parameter Changeover Function Parameter Table0	Filter setting 4th time	0313	1	00	00 : No Filter 01 : Erode (Compression) 02 : Dilate (Expansion) 03 : Open 04 : Close 05 : Histogram Equalization(Averaging) 06 : Sharpening 07 : Smoothing	
	Reserved	0314	1	-	-	
	Code39 Enable Setting	0315	1	01	00 : Disabled 01 : Enabled	
	Codabar (NW7) Enable Setting	0316	1	01	00 : Disabled 01 : Enabled	
	Interleaved 2of5 Enable Setting	0317	1	01	00 : Disabled 01 : Enabled	
	Standard 2of5 Enable Setting	0318	1	01	00 : Disabled 01 : Enabled	
	Matrix 2of5 Enable Setting	0319	1	01	00 : Disabled 01 : Enabled	
	IATA 2of5 Enable Setting	031A	1	00	00 : Disabled 01 : Enabled	
	Coop 2of5 Enable Setting	031B	1	00	00 : Disabled 01 : Enabled	
	Scode Enable Setting	031C	1	00	00 : Disabled 01 : Enabled	
	Chinese Post Matrix Enable Setting	031D	1	00	00 : Disabled 01 : Enabled	
	UPC-A Enable Setting	031E	1	01	00 : Disabled 01 : Enabled	
	UPC-E0 Enable Setting	031F	1	01	00 : Disabled 01 : Enabled	
	UPC-E1 Enable Setting	0320	1	01	00 : Disabled 01 : Enabled	
	EAN-13 Enable Setting	0321	1	01	00 : Disabled 01 : Enabled	
	EAN-8 Enable Setting	0322	1	01	00 : Disabled 01 : Enabled	
	Code128 Enable Setting	0323	1	01	00 : Disabled 01 : Enabled	
	GS1-128 Enable Setting	0324	1	00	00 : Disabled 01 : Enabled	
	Code93 Enable Setting	0325	1	01	00 : Disabled 01 : Enabled	
	MSI/Plessey Enable Setting	0326	1	00	00 : Disabled 01 : Enabled	
	Italian Pharm (Code32) Enable Setting	0327	1	00	00 : Disabled 01 : Enabled	
	CIP39 Enable Setting	0328	1	00	00 : Disabled 01 : Enabled	
	Tri-Optic Enable Setting	0329	1	00	00 : Disabled 01 : Enabled	
	TELEPEN Enable Setting	032A	1	00	00 : Disabled 01 : Enabled	
	Code11 Enable Setting	032B	1	00	00 : Disabled 01 : Enabled	

Item	Sub item	Address (hex)	Size (dec)	Default (hex)	Setting value (hex)	Remarks
Reading Parameter Changeover Function Parameter Table0	GS1 Databar Expanded Enable Setting	032C	1	00	00 : Disabled 01 : Enabled	
	GS1 Databar Limited Enable Setting	032D	1	00	00 : Disabled 01 : Enabled	
	GS1 Databar Omni-directional Enable Setting	032E	1	00	00 : Disabled 01 : Enabled	
	Reserved	032F-033B	13	-	-	
	DataMatrix ECC200 Enable Setting	033C	1	01	00 : Disabled 01 : Enabled	
	QR Code Enable Setting	033D	1	01	00 : Disabled 01 : Enabled	
	Micro QR Code Enable Setting	033E	1	01	00 : Disabled 01 : Enabled	
	PDF417 Enable Setting	033F	1	00	00 : Disabled 01 : Enabled	
	Micro PDF417 Enable Setting	0340	1	00	00 : Disabled 01 : Enabled	
	Reserved	0341	1	-	-	
	Reserved	0342	1	-	-	
	Composite CC-A/B Enable Setting	0343	1	00	00 : Disabled 01 : Enabled	
	Composite CC-C Enable Setting	0344	1	00	00 : Disabled 01 : Enabled	
	Reserved	0345	1	-	-	
	Reserved	0346	1	-	-	
	GS1-Databar Stacked Omni directional Enable Setting	0347	1	00	00 : Disabled 01 : Enabled	
	GS1-Databar Expanded Stacked Enable Setting	0348	1	00	00 : Disabled 01 : Enabled	
	Japan Postal Code Enable Setting	0349	1	00	00 : Disabled 01 : Enabled	
	Reserved	034A-035F	22	-	-	
	Reading Parameter Changeover Function Parameter Table 1 to 7	Parameter Table1	0360-03BF	96		
Parameter Table2		03C0-041F	96			
Parameter Table3		0420-047F	96			
Parameter Table		0480-04DF	96			
Parameter Table5		04E0-053F	96			
Parameter Table6		0540-059F	96			
Parameter Table7		05A0-05FF	96			
Reserved	0600-0B7F	580	-	-		
Capture Function	Imaging size	0B80	1	00	00 : QuadVGA 01 : 720P 02 : WVGA	
	Image quality	0B81	1	00	00 : High density 01 : Low density	
	Reserved	0B82-0B8B	10	-	-	
	Number of LED's lit	0B8C	1	00	00 : 4 lights (Boost) 01 : Top 2 lights (Boost) 02 : Bottom 2 lights (Boost) 03 : 4 lights (Normal) 04 : Top 2 lights (Normal) 05 : Bottom 2 lights(Normal) FF : OFF	

Item	Sub item	Address (hex)	Size (dec)	Default (hex)	Setting value (hex)	Remarks
Capture Function	Horizontal inversion of the image	0B8D	1	00	00 : None 01 : Flip horizontally	
	Reserved	0B8E	1	-	-	
	Reserved	0B8F	1	-	-	
	Auto image save destination	0B90	1	00	00 : Do not save 01 : Temporary Image memory 02 : Non-volatile image memory	If the value "02H" is set for non-volatile image memory, images saved in temporary images will be discarded
	Auto image save	0B91	1	00	00 : Read Fail image 01 : Read Success image 02 : Read Failure/Read Success image	
	Reserved	0B92-0BFF	110	01	-	
Reserved	0C00-0CFF	256	-	-		
Auto-tuning function	Reading parameter table registration destination number	0D00	1	00	00 - 07 : Destination Table of Registration	
	Tuning mode	0D01	1	00	00 : High speed mode 01 : Detail Mode	High Speed Mode : Performs auto-tuning process at high speed Detail Mode : Performs detailed auto-tuning
	Exposure time limit value	0D02	2	00	0000 : No Limit 0003 - 0168 : Setting value by 27.76us step (QuadVGA)	Sets the maximum limit for exposure time in the Reading parameter table.
		0D03		00	Setting value by 30.00us step (Other than QuadVGA)	
	Symbol Registration	0D04	1	01	00 : Register additional codes that were tuned 01 : Register only tuned symbols	Configure the symbol registration method
	White Black Reversal Read	0D05	1	01	00 : Normal 01 : Normal/ Reverse 02 : Reverse	Configure based on the symbol used for tuning. 00 : Specific to the symbol that has bright background and dark code. 02 : Specific to the symbol that has dark background and bright code.
	Image Filter	0D06	1	00	00 : Disabled 01 : Enabled	Configures whether you would like to use image filters in the auto-tuning process

Item	Sub item	Address (hex)	Size (dec)	Default (hex)	Setting value (hex)	Remarks
Auto-tuning function	Imaging parameters	0D07	1	04	00 : Prioritize distance range (near and far) 01 : Prioritize success rate (applied) 02 : Prioritize distance range (far) 03 : Prioritize distance range (near) 04 : Prioritize success rate (standard)	Configure exposure time, analog gain and digital gain in the read parameter table based on as follows. 00 : If the symbol position shifts from the tuning position to both nearer and farther. 01 : Setting with high reading success rate of the symbol used for tuning. If quality of symbols are inconsistent such as different shade of gray 02 : If the symbol position shifts from the tuning position to farther 03 : If the symbol position shifts from the tuning position to nearer 04 : Setting with maximizes the read success rate of the symbol used for tuning. If quality of symbols are stability
	Decode Parameter	0D08	1	01	00 : Prioritize read rate 01 : Standard 02 : Prioritize read performance	Configure the decode mode in the read parameter table based on as follows. 00 : Minimize decode processing time 01 : Read standard symbols 02 : Read difficult to read symbols such as DPM symbols
	Auto-tuning Reading Timeout	0D09	1	0A	01 - FF : 1 - 255 s	Configures the read timeout during auto-tuning
	Reserved	0D0A-0D10	7	-	-	
	Code39 Enable Setting	0D11	1	01	00 : Disabled 01 : Enabled	Performs tuning with the enabled symbol. Tuning time can be minimized by disabling unnecessary symbols.
	Codabar(NW7) Enable Setting	0D12	1	01	00 : Disabled 01 : Enabled	
	Interleaved 2of5 Enable Setting	0D13	1	01	00 : Disabled 01 : Enabled	
	Standard 2of5 Enable Setting	0D14	1	01	00 : Disabled 01 : Enabled	
	Matrix 2of5 Enable Setting	0D15	1	01	00 : Disabled 01 : Enabled	
	IATA 2of5 Enable Setting	0D16	1	01	00 : Disabled 01 : Enabled	
	Coop 2of5 Enable Setting	0D17	1	01	00 : Disabled 01 : Enabled	
	Scode Enable Setting	0D18	1	01	00 : Disabled 01 : Enabled	
	Chinese Post Matrix Enable Setting	0D19	1	01	00 : Disabled 01 : Enabled	
	UPC-A Enable Setting	0D1A	1	01	00 : Disabled 01 : Enabled	
	UPC-E0 Enable Setting	0D1B	1	01	00 : Disabled 01 : Enabled	

Item	Sub item	Address (hex)	Size (dec)	Default (hex)	Setting value (hex)	Remarks
Auto-tuning function	UPC-E1 Enable Setting	0D1C	1	01	00 : Disabled 01 : Enabled	Performs tuning with the enabled symbol. Tuning time can be minimized by disabling unnecessary symbols.
	EAN-13 Enable Setting	0D1D	1	01	00 : Disabled 01 : Enabled	
	EAN-8 Enable Setting	0D1E	1	01	00 : Disabled 01 : Enabled	
	Code128 Enable Setting	0D1F	1	01	00 : Disabled 01 : Enabled	
	GS1-128 Enable Setting	0D20	1	01	00 : Disabled 01 : Enabled	
	Code93 Enable Setting	0D21	1	01	00 : Disabled 01 : Enabled	
	MSI/Plessey Enable Setting	0D22	1	01	00 : Disabled 01 : Enabled	
	Italian Pharm (Code32) Enable Setting	0D23	1	01	00 : Disabled 01 : Enabled	
	CIP39 Enable Setting	0D24	1	01	00 : Disabled 01 : Enabled	
	Tri-Optic Enable Setting	0D25	1	01	00 : Disabled 01 : Enabled	
	TELEPEN Enable Setting	0D26	1	01	00 : Disabled 01 : Enabled	
	Code11 Enable Setting	0D27	1	01	00 : Disabled 01 : Enabled	
	GS1 Databar Expanded Enable Setting	0D28	1	01	00 : Disabled 01 : Enabled	
	GS1 Databar Limited Enable Setting	0D29	1	01	00 : Disabled 01 : Enabled	
	GS1 Databar Omni-directional Enable Setting	0D2A	1	01	00 : Disabled 01 : Enabled	
	Reserved	0D2B-0D37	13	-	-	
	DataMatrix ECC200 Enable Setting	0D38	1	01	00 : Disabled 01 : Enabled	Performs tuning with the enabled symbol. Tuning time can be minimized by disabling unnecessary symbols.
	QR Code Enable Setting	0D39	1	01	00 : Disabled 01 : Enabled	
	Micro QR Code Enable Setting	0D3A	1	01	00 : Disabled 01 : Enabled	
	PDF417 Enable Setting	0D3B	1	01	00 : Disabled 01 : Enabled	
	Micro PDF417 Enable Setting	0D3C	1	01	00 : Disabled 01 : Enabled	
	Reserved	0D3D	1	-	-	
	Reserved	0D3E	1	-	-	
	Composite CC-A/B Enable Setting	0D3F	1	01	00 : Disabled 01 : Enabled	Performs tuning with the enabled symbol. Tuning time can be minimized by disabling unnecessary symbols.
	Composite CC-C Enable Setting	0D40	1	01	00 : Disabled 01 : Enabled	
	Reserved	0D41	1	-	-	
	Reserved	0D42	1	-	-	
GS1-Databar Stacked Omni directional Enable Setting	0D43	1	01	00 : Disabled 01 : Enabled	Performs tuning with the enabled symbol. Tuning time can be minimized by disabling unnecessary symbols.	

Item	Sub item	Address (hex)	Size (dec)	Default (hex)	Setting value (hex)	Remarks	
Auto-tuning function	GS1-Databar Expanded Stacked Enable Setting	0D44	1	01	00 : Disabled 01 : Enabled	Performs tuning with the enabled symbol. Tuning time can be minimized by disabling unnecessary symbols.	
	Japan Postal Code Enable Setting	0D45	1	01	00 : Disabled 01 : Enabled		
	Reserved	0D46-0DFF	186	-	-		
Reserved		0E00-0FFF	512	-	-		
Output data additional information	Global Prefix	1000	1	00	00 : Disabled 01 : Enabled	You can set the data to be added to each type of symbol.	
	Global Suffix	1001	1	01	00 : Disabled 01 : Enabled		
	Local Prefix	1002	1	00	00 : Disabled 01 : Enabled		
	Local Suffix	1003	1	00	00 : Disabled 01 : Enabled		
	Data size	1004	1	00	00 : Disabled 01 : Enabled		
	Reserved	1005	1	-	-		
	Elapsed time	1006	1	00	00 : Disabled 01 : Enabled		
	AIM ID	1007	1	00	00 : Disabled 01 : Enabled		
	Reserved	1008	1	-	-		
	Reserved	1009	1	-	-		
	Symbol Length	100A	1	00	00 : Disabled 01 : Enabled		
	Reserved	100B	1	-	-		
	Check digit	100C	1	00	00 : Disabled 01 : Enabled		
	Label Option	100D	1	00	00 : Disabled 01 : Enabled		
	Batch output separator specification	100E	1	00	00 : Disabled 01 : Enabled		
	Output addition when reading failed	100F	1	01	00 : Disabled 01 : Enabled		
	No response when reading failed	1010	1	00	00 : Disabled 01 : Enabled		When the setting is enabled no data is output if a Read Failure occurs.
	Reserved	1011	1	-	-		
	Batch output Global prefix suppression	1012	1	00	00 : Disabled 01 : Enabled		Global prefix will only be added to the first output data when performing batch output.
	Position Information	1013	1	00	00 : Disabled 01 : Enabled		
	Reserved	1014-103F	44	-	-		
	Global Prefix data	1040	8	5E	00 - FF : ASCII code		
		1041		00	00 - FF : ASCII code		
1042		00		00 - FF : ASCII code			
1043		00		00 - FF : ASCII code			
1044		00		00 - FF : ASCII code			
1045		00		00 - FF : ASCII code			
1046		00		00 - FF : ASCII code			
1047		00		00 - FF : ASCII code			

Item	Sub item	Address (hex)	Size (dec)	Default (hex)	Setting value (hex)	Remarks
Output data additional information	Global Suffix data	1048	8	0D	00 - FF : ASCII code	
		1049		0A	00 - FF : ASCII code	
		104A		00	00 - FF : ASCII code	
		104B		00	00 - FF : ASCII code	
		104C		00	00 - FF : ASCII code	
		104D		00	00 - FF : ASCII code	
		104E		00	00 - FF : ASCII code	
		104F		00	00 - FF : ASCII code	
	Output string data when reading failed	1050	8	3F	00 - FF : ASCII code	The initial state is a "?" response when reading fails.
		1051		00	00 - FF : ASCII code	
		1052		00	00 - FF : ASCII code	
		1053		00	00 - FF : ASCII code	
		1054		00	00 - FF : ASCII code	
		1055		00	00 - FF : ASCII code	
		1056		00	00 - FF : ASCII code	
		1057		00	00 - FF : ASCII code	
	Batch output separator data	1058	8	3A	00 - FF : ASCII code	
		1059		00	00 - FF : ASCII code	
		105A		00	00 - FF : ASCII code	
		105B		00	00 - FF : ASCII code	
		105C		00	00 - FF : ASCII code	
		105D		00	00 - FF : ASCII code	
		105E		00	00 - FF : ASCII code	
		105F		00	00 - FF : ASCII code	
	Reserved	1060-107F	32	-	-	
	Local Prefix data reading failure	1080	4	50	00 - FF : ASCII code	
		1081		30	00 - FF : ASCII code	
		1082		30	00 - FF : ASCII code	
		1083		3B	00 - FF : ASCII code	
	Local Prefix data Code39	1084	4	50	00 - FF : ASCII code	
		1085		30	00 - FF : ASCII code	
		1086		31	00 - FF : ASCII code	
		1087		3B	00 - FF : ASCII code	
	Local Prefix data Codabar (NW7)	1088	4	50	00 - FF : ASCII code	
		1089		30	00 - FF : ASCII code	
		108A		32	00 - FF : ASCII code	
		108B		3B	00 - FF : ASCII code	
	Local Prefix data Interleaved 2of5	108C	4	50	00 - FF : ASCII code	
		108D		30	00 - FF : ASCII code	
		108E		33	00 - FF : ASCII code	
108F		3B		00 - FF : ASCII code		
Local Prefix data Standard 2of5	1090	4	50	00 - FF : ASCII code		
	1091		30	00 - FF : ASCII code		
	1092		34	00 - FF : ASCII code		
	1093		3B	00 - FF : ASCII code		
Local Prefix data Matrix 2of5	1094	4	50	00 - FF : ASCII code		
	1095		30	00 - FF : ASCII code		
	1096		35	00 - FF : ASCII code		
	1097		3B	00 - FF : ASCII code		
Local Prefix data IATA 2of5	1098	4	50	00 - FF : ASCII code		
	1099		30	00 - FF : ASCII code		
	109A		36	00 - FF : ASCII code		
	109B		3B	00 - FF : ASCII code		
Local Prefix data COOP 2of5	109C	4	50	00 - FF : ASCII code		
	109D		30	00 - FF : ASCII code		
	109E		37	00 - FF : ASCII code		
	109F		3B	00 - FF : ASCII code		

Item	Sub item	Address (hex)	Size (dec)	Default (hex)	Setting value (hex)	Remarks
Output data additional information	Local Prefix data Scode	10A0	4	50	00 - FF : ASCII code	
		10A1		30	00 - FF : ASCII code	
		10A2		38	00 - FF : ASCII code	
		10A3		3B	00 - FF : ASCII code	
	Local Prefix data Chinese Post Matrix	10A4	4	50	00 - FF : ASCII code	
		10A5		30	00 - FF : ASCII code	
		10A6		39	00 - FF : ASCII code	
		10A7		3B	00 - FF : ASCII code	
	Local Prefix data UPC-A	10A8	4	50	00 - FF : ASCII code	
		10A9		30	00 - FF : ASCII code	
		10AA		61	00 - FF : ASCII code	
		10AB		3B	00 - FF : ASCII code	
	Local Prefix data UPC-E0	10AC	4	50	00 - FF : ASCII code	
		10AD		30	00 - FF : ASCII code	
		10AE		62	00 - FF : ASCII code	
		10AF		3B	00 - FF : ASCII code	
	Local Prefix data UPC-E1	10B0	4	50	00 - FF : ASCII code	
		10B1		30	00 - FF : ASCII code	
		10B2		63	00 - FF : ASCII code	
		10B3		3B	00 - FF : ASCII code	
	Local Prefix data EAN-13	10B4	4	50	00 - FF : ASCII code	
		10B5		30	00 - FF : ASCII code	
		10B6		64	00 - FF : ASCII code	
		10B7		3B	00 - FF : ASCII code	
	Local Prefix data EAN-8	10B8	4	50	00 - FF : ASCII code	
		10B9		30	00 - FF : ASCII code	
		10BA		65	00 - FF : ASCII code	
		10BB		3B	00 - FF : ASCII code	
	Local Prefix data Code128	10BC	4	50	00 - FF : ASCII code	
		10BD		30	00 - FF : ASCII code	
		10BE		66	00 - FF : ASCII code	
		10BF		3B	00 - FF : ASCII code	
	Local Prefix data GS1-128	10C0	4	50	00 - FF : ASCII code	
		10C1		31	00 - FF : ASCII code	
		10C2		30	00 - FF : ASCII code	
		10C3		3B	00 - FF : ASCII code	
	Local Prefix data Code93	10C4	4	50	00 - FF : ASCII code	
		10C5		31	00 - FF : ASCII code	
		10C6		31	00 - FF : ASCII code	
		10C7		3B	00 - FF : ASCII code	
Local Prefix data MSI/Plessey	10C8	4	50	00 - FF : ASCII code		
	10C9		31	00 - FF : ASCII code		
	10CA		32	00 - FF : ASCII code		
	10CB		3B	00 - FF : ASCII code		
Local Prefix data Italian Pharmacy (Code32)	10CC	4	50	00 - FF : ASCII code		
	10CD		31	00 - FF : ASCII code		
	10CE		33	00 - FF : ASCII code		
	10CF		3B	00 - FF : ASCII code		
Local Prefix data CIP39	10D0	4	50	00 - FF : ASCII code		
	10D1		31	00 - FF : ASCII code		
	10D2		34	00 - FF : ASCII code		
	10D3		3B	00 - FF : ASCII code		
Local Prefix data Tri-Optic	10D4	4	50	00 - FF : ASCII code		
	10D5		31	00 - FF : ASCII code		
	10D6		35	00 - FF : ASCII code		
	10D7		3B	00 - FF : ASCII code		

Item	Sub item	Address (hex)	Size (dec)	Default (hex)	Setting value (hex)	Remarks
Output data additional information	Local Prefix data TELEPEN	10D8	4	50	00 - FF : ASCII code	
		10D9		31	00 - FF : ASCII code	
		10DA		36	00 - FF : ASCII code	
		10DB		3B	00 - FF : ASCII code	
	Local Prefix data Code11	10DC	4	50	00 - FF : ASCII code	
		10DD		31	00 - FF : ASCII code	
		10DE		37	00 - FF : ASCII code	
		10DF		3B	00 - FF : ASCII code	
	Local Prefix data GS1 Databar Expanded	10E0	4	50	00 - FF : ASCII code	
		10E1		31	00 - FF : ASCII code	
		10E2		38	00 - FF : ASCII code	
		10E3		3B	00 - FF : ASCII code	
	Local Prefix data GS1 Databar Limited	10E4	4	50	00 - FF : ASCII code	
		10E5		31	00 - FF : ASCII code	
		10E6		39	00 - FF : ASCII code	
		10E7		3B	00 - FF : ASCII code	
	Local Prefix data GS1 Databar Omni-directional	10E8	4	50	00 - FF : ASCII code	
		10E9		31	00 - FF : ASCII code	
		10EA		61	00 - FF : ASCII code	
		10EB		3B	00 - FF : ASCII code	
	Reserved	10EC-111F	52	-	-	
	Local Prefix data DataMatrix	1120	4	50	00 - FF : ASCII code	
		1121		32	00 - FF : ASCII code	
		1122		38	00 - FF : ASCII code	
		1123		3B	00 - FF : ASCII code	
	Local Prefix data QR Code	1124	4	50	00 - FF : ASCII code	
		1125		32	00 - FF : ASCII code	
		1126		39	00 - FF : ASCII code	
		1127		3B	00 - FF : ASCII code	
	Local Prefix data Micro QR Code	1128	4	50	00 - FF : ASCII code	
		1129		32	00 - FF : ASCII code	
		112A		61	00 - FF : ASCII code	
		112B		3B	00 - FF : ASCII code	
	Local Prefix data PDF417	112C	4	50	00 - FF : ASCII code	
		112D		32	00 - FF : ASCII code	
		112E		62	00 - FF : ASCII code	
		112F		3B	00 - FF : ASCII code	
	Local Prefix data Micro PDF417	1130	4	50	00 - FF : ASCII code	
		1131		32	00 - FF : ASCII code	
		1132		63	00 - FF : ASCII code	
1133		3B		00 - FF : ASCII code		
Reserved	1134-113B	8	-	-		
Local Prefix data Composite CC-A/B	113C	4	50	00 - FF : ASCII code		
	113D		32	00 - FF : ASCII code		
	113E		66	00 - FF : ASCII code		
	113F		3B	00 - FF : ASCII code		
Local Prefix data Composite CC-C	1140	4	50	00 - FF : ASCII code		
	1141		33	00 - FF : ASCII code		
	1142		30	00 - FF : ASCII code		
	1143		3B	00 - FF : ASCII code		
Reserved	1144-114B	8	-	-		
Local Prefix data GS1-Databar Stacked Omni directional	114C	4	50	00 - FF : ASCII code		
	114D		33	00 - FF : ASCII code		
	114E		33	00 - FF : ASCII code		
	114F		3B	00 - FF : ASCII code		

Item	Sub item	Address (hex)	Size (dec)	Default (hex)	Setting value (hex)	Remarks
Output data additional information	Local Prefix data GS1 Databar Expanded Stacked	1150	4	50	00 - FF : ASCII code	
		1151		33	00 - FF : ASCII code	
		1152		34	00 - FF : ASCII code	
		1153		3B	00 - FF : ASCII code	
	Local Prefix data Japan Postal Code	1154	4	50	00 - FF : ASCII code	
		1155		33	00 - FF : ASCII code	
		1156		35	00 - FF : ASCII code	
		1157		3B	00 - FF : ASCII code	
	Reserved	1158-117F	40	-	-	
	Local Suffix data reading failure	1180	4	53	00 - FF : ASCII code	
		1181		30	00 - FF : ASCII code	
		1182		30	00 - FF : ASCII code	
		1183		3B	00 - FF : ASCII code	
	Local Suffix data Code39	1184	4	53	00 - FF : ASCII code	
		1185		30	00 - FF : ASCII code	
		1186		31	00 - FF : ASCII code	
		1187		3B	00 - FF : ASCII code	
	Local Suffix data Codabar (NW7)	1188	4	53	00 - FF : ASCII code	
		1189		30	00 - FF : ASCII code	
		118A		32	00 - FF : ASCII code	
		118B		3B	00 - FF : ASCII code	
	Local Suffix data Interleaved 2of5	118C	4	53	00 - FF : ASCII code	
		118D		30	00 - FF : ASCII code	
		118E		33	00 - FF : ASCII code	
		118F		3B	00 - FF : ASCII code	
	Local Suffix data Standard 2of5	1190	4	53	00 - FF : ASCII code	
		1191		30	00 - FF : ASCII code	
		1192		34	00 - FF : ASCII code	
		1193		3B	00 - FF : ASCII code	
	Local Suffix data Matrix 2of5	1194	4	53	00 - FF : ASCII code	
		1195		30	00 - FF : ASCII code	
		1196		35	00 - FF : ASCII code	
		1197		3B	00 - FF : ASCII code	
	Local Suffix data IATA 2of5	1198	4	53	00 - FF : ASCII code	
		1199		30	00 - FF : ASCII code	
		119A		36	00 - FF : ASCII code	
		119B		3B	00 - FF : ASCII code	
	Local Suffix data COOP 2of5	119C	4	53	00 - FF : ASCII code	
		119D		30	00 - FF : ASCII code	
		119E		37	00 - FF : ASCII code	
		119F		3B	00 - FF : ASCII code	
	Local Suffix data Scode	11A0	4	53	00 - FF : ASCII code	
		11A1		30	00 - FF : ASCII code	
		11A2		38	00 - FF : ASCII code	
		11A3		3B	00 - FF : ASCII code	
	Local Suffix data Chinese Post Matrix	11A4	4	53	00 - FF : ASCII code	
		11A5		30	00 - FF : ASCII code	
		11A6		39	00 - FF : ASCII code	
11A7		3B		00 - FF : ASCII code		
Local Suffix data UPC-A	11A8	4	53	00 - FF : ASCII code		
	11A9		30	00 - FF : ASCII code		
	11AA		61	00 - FF : ASCII code		
	11AB		3B	00 - FF : ASCII code		
Local Suffix data UPC-E0	11AC	4	53	00 - FF : ASCII code		
	11AD		30	00 - FF : ASCII code		
	11AE		62	00 - FF : ASCII code		
	11AF		3B	00 - FF : ASCII code		

Item	Sub item	Address (hex)	Size (dec)	Default (hex)	Setting value (hex)	Remarks
Output data additional information	Local Suffix data UPC-E1	11B0	4	53	00 - FF : ASCII code	
		11B1		30	00 - FF : ASCII code	
		11B2		63	00 - FF : ASCII code	
		11B3		3B	00 - FF : ASCII code	
	Local Suffix data EAN-13	11B4	4	53	00 - FF : ASCII code	
		11B5		30	00 - FF : ASCII code	
		11B6		64	00 - FF : ASCII code	
		11B7		3B	00 - FF : ASCII code	
	Local Suffix data EAN-8	11B8	4	53	00 - FF : ASCII code	
		11B9		30	00 - FF : ASCII code	
		11BA		65	00 - FF : ASCII code	
		11BB		3B	00 - FF : ASCII code	
	Local Suffix data Code128	11BC	4	53	00 - FF : ASCII code	
		11BD		30	00 - FF : ASCII code	
		11BE		66	00 - FF : ASCII code	
		11BF		3B	00 - FF : ASCII code	
	Local Suffix data GS1-128	11C0	4	53	00 - FF : ASCII code	
		11C1		31	00 - FF : ASCII code	
		11C2		30	00 - FF : ASCII code	
		11C3		3B	00 - FF : ASCII code	
	Local Suffix data Code93	11C4	4	53	00 - FF : ASCII code	
		11C5		31	00 - FF : ASCII code	
		11C6		31	00 - FF : ASCII code	
		11C7		3B	00 - FF : ASCII code	
	Local Suffix data MSI/Plessey	11C8	4	53	00 - FF : ASCII code	
		11C9		31	00 - FF : ASCII code	
		11CA		32	00 - FF : ASCII code	
		11CB		3B	00 - FF : ASCII code	
	Local Suffix data Italian Pharmacy (Code32)	11CC	4	53	00 - FF : ASCII code	
		11CD		31	00 - FF : ASCII code	
		11CE		33	00 - FF : ASCII code	
		11CF		3B	00 - FF : ASCII code	
	Local Suffix data CIP39	11D0	4	53	00 - FF : ASCII code	
		11D1		31	00 - FF : ASCII code	
		11D2		34	00 - FF : ASCII code	
		11D3		3B	00 - FF : ASCII code	
	Local Suffix data Tri-Optic	11D4	4	53	00 - FF : ASCII code	
		11D5		31	00 - FF : ASCII code	
		11D6		35	00 - FF : ASCII code	
		11D7		3B	00 - FF : ASCII code	
Local Suffix data TELEPEN	11D8	4	53	00 - FF : ASCII code		
	11D9		31	00 - FF : ASCII code		
	11DA		36	00 - FF : ASCII code		
	11DB		3B	00 - FF : ASCII code		
Local Suffix data Code11	11DC	4	53	00 - FF : ASCII code		
	11DD		31	00 - FF : ASCII code		
	11DE		37	00 - FF : ASCII code		
	11DF		3B	00 - FF : ASCII code		
Local Suffix data GS1 Databar Expanded	11E0	4	53	00 - FF : ASCII code		
	11E1		31	00 - FF : ASCII code		
	11E2		38	00 - FF : ASCII code		
	11E3		3B	00 - FF : ASCII code		

Item	Sub item	Address (hex)	Size (dec)	Default (hex)	Setting value (hex)	Remarks
Output data additional information	Local Suffix data GS1 Databar Limited	11E4	4	53	00 - FF : ASCII code	
		11E5		31	00 - FF : ASCII code	
		11E6		39	00 - FF : ASCII code	
		11E7		3B	00 - FF : ASCII code	
	Local Suffix data GS1 Databar Omni-directional	11E8	4	53	00 - FF : ASCII code	
		11E9		31	00 - FF : ASCII code	
		11EA		61	00 - FF : ASCII code	
		11EB		3B	00 - FF : ASCII code	
	Reserved	11EC-121F	52	-	-	
	Local Suffix data DataMatrix	1220	4	53	00 - FF : ASCII code	
		1221		32	00 - FF : ASCII code	
		1222		38	00 - FF : ASCII code	
		1223		3B	00 - FF : ASCII code	
	Local Suffix data QR Code	1224	4	53	00 - FF : ASCII code	
		1225		32	00 - FF : ASCII code	
		1226		39	00 - FF : ASCII code	
		1227		3B	00 - FF : ASCII code	
	Local Suffix data Micro QR Code	1228	4	53	00 - FF : ASCII code	
		1229		32	00 - FF : ASCII code	
		122A		61	00 - FF : ASCII code	
		122B		3B	00 - FF : ASCII code	
	Local Suffix data PDF417	122C	4	53	00 - FF : ASCII code	
		122D		32	00 - FF : ASCII code	
		122E		62	00 - FF : ASCII code	
		122F		3B	00 - FF : ASCII code	
	Local Suffix data Micro PDF417	1230	4	53	00 - FF : ASCII code	
		1231		32	00 - FF : ASCII code	
		1232		63	00 - FF : ASCII code	
		1233		3B	00 - FF : ASCII code	
	Reserved	1234-123B	4	-	-	
	Local Suffix data Composite CC-A/B	123C	4	53	00 - FF : ASCII code	
		123D		32	00 - FF : ASCII code	
123E		66		00 - FF : ASCII code		
123F		3B		00 - FF : ASCII code		
Local Suffix data Composite CC-C	1240	4	53	00 - FF : ASCII code		
	1241		33	00 - FF : ASCII code		
	1242		30	00 - FF : ASCII code		
	1243		3B	00 - FF : ASCII code		
Reserved	1244-124B	8	-	-		
Local Suffix data GS1-Databar Stacked Omni directional	124C	4	53	00 - FF : ASCII code		
	124D		33	00 - FF : ASCII code		
	124E		33	00 - FF : ASCII code		
	124F		3B	00 - FF : ASCII code		
Local Suffix data GS1-Databar Expanded Stacked	1250	4	53	00 - FF : ASCII code		
	1251		33	00 - FF : ASCII code		
	1252		34	00 - FF : ASCII code		
	1253		3B	00 - FF : ASCII code		
Local Suffix data Japan Postal Code	1254	4	53	00 - FF : ASCII code		
	1255		33	00 - FF : ASCII code		
	1256		35	00 - FF : ASCII code		
	1257		3B	00 - FF : ASCII code		
Reserved	1258-1280	168	-	-		

Item	Sub item	Address (hex)	Size (dec)	Default (hex)	Setting value (hex)	Remarks
Output data editing	Function enabled	1300	1	00	00 : Disabled 01 : Enabled	
	Extraction start position[0]	1301	2	00	0000 - 1BB0 : From the 0th Character to the 7,088th character	
		1302		00		
	Extraction start position[1]	1303	2	00	0000 - 1BB0 : From the 0th Character to the 7,088th character	
		1304		00		
	Extraction start position[2]	1305	2	00	0000 - 1BB0 : From the 0th Character to the 7,088th character	
		1306		00		
	Extraction start position[3]	1307	2	00	0000 - 1BB0 : From the 0th Character to the 7,088th character	
		1308		00		
	Number of characters for extraction[0]	1309	2	00	0001 - 1BB1 : From 1 to 7,098 characters	If the setting value is 00, extraction is not performed.
		130A		00		
	Number of characters for extraction[1]	130B	2	00	0001 - 1BB1 : From 1 to 7,098 characters	
		130C		00		
Number of characters for extraction[2]	130D	2	00	0001 - 1BB1 : From 1 to 7,098 characters		
	130E		00			
Number of characters for extraction[3]	130F	2	00	0001 - 1BB1 : From 1 to 7,098 characters		
	1310		00			
Replacement Character Code	1311	1	00	00 : No replacement 01 - FF : ASCII code		
Reserved	1312-133F	46	-	-		
Verification	Function enabled	1340	1	00	00 : Disabled 01 : Enabled	
	Reserved	1341-134F	15	-	-	
	Master Data[0]	1350-138F	64	00	00 - FF : ASCII code	
	Master Data[1]	1390-13CF	64	00	00 - FF : ASCII code	
	Master Data[2]	13D0-140F	64	00	00 - FF : ASCII code	
	Master Data[3]	1410-144F	64	00	00 - FF : ASCII code	
	Master Data[4]	1450-148F	64	00	00 - FF : ASCII code	
	Master Data[5]	1490-14CF	64	00	00 - FF : ASCII code	
	Master Data[6]	14D0-150F	64	00	00 - FF : ASCII code	
	Master Data[7]	1510-154F	64	00	00 - FF : ASCII code	
	Master Data[8]	1550-158F	64	00	00 - FF : ASCII code	
	Master Data[9]	1590-15CF	64	00	00 - FF : ASCII code	
	Master Data[10]	15D0-160F	64	00	00 - FF : ASCII code	
	Master Data[11]	1610-164F	64	00	00 - FF : ASCII code	
	Master Data[12]	1650-168F	64	00	00 - FF : ASCII code	
	Master Data[13]	1690-16CF	64	00	00 - FF : ASCII code	
	Master Data[14]	16D0-170F	64	00	00 - FF : ASCII code	
	Master Data[15]	1710-174F	64	00	00 - FF : ASCII code	
Reserved	1750	1	-	-		
Reserved	1760-1FFF	2280	-	-		
Command alias	Function enabled	2000	1	00	00 : Disabled 01 : Enabled	
	Reserved	2001	1	-	-	
	Reserved	2002	1	-	-	
	Reserved	2003	1	-	-	



Item	Sub item	Address (hex)	Size (dec)	Default (hex)	Setting value (hex)	Remarks
Command alias	Start symbol read command[0]	2004	16	4C	00 - FF : ASCII code	
		2005		4F	00 - FF : ASCII code	
		2006		4E	00 - FF : ASCII code	
		2007		0D	00 - FF : ASCII code	
		2008		00	00 - FF : ASCII code	
		2009		00	00 - FF : ASCII code	
		200A		00	00 - FF : ASCII code	
		200B		00	00 - FF : ASCII code	
		200C		00	00 - FF : ASCII code	
		200D		00	00 - FF : ASCII code	
		200E		00	00 - FF : ASCII code	
		200F		00	00 - FF : ASCII code	
		2010		00	00 - FF : ASCII code	
		2011		00	00 - FF : ASCII code	
	2012	00	00 - FF : ASCII code			
	2013	00	00 - FF : ASCII code			
	Start symbol read command[1]	2014	16	1B	00 - FF : ASCII code	
		2015		5A	00 - FF : ASCII code	
		2016		0D	00 - FF : ASCII code	
		2017		00	00 - FF : ASCII code	
		2018		00	00 - FF : ASCII code	
		2019		00	00 - FF : ASCII code	
		201A		00	00 - FF : ASCII code	
		201B		00	00 - FF : ASCII code	
		201C		00	00 - FF : ASCII code	
		201D		00	00 - FF : ASCII code	
		201E		00	00 - FF : ASCII code	
	Start symbol read command[2]	201F	16	00	00 - FF : ASCII code	
		2020		00	00 - FF : ASCII code	
		2021		00	00 - FF : ASCII code	
		2022		00	00 - FF : ASCII code	
		2023		00	00 - FF : ASCII code	
		2024		47	00 - FF : ASCII code	
2025		00		00 - FF : ASCII code		
2026		00		00 - FF : ASCII code		
2027		00		00 - FF : ASCII code		
2028		00		00 - FF : ASCII code		
2029		00		00 - FF : ASCII code		
202A		00		00 - FF : ASCII code		
202B	00	00 - FF : ASCII code				
202C	00	00 - FF : ASCII code				
202D	00	00 - FF : ASCII code				
202E	00	00 - FF : ASCII code				
202F	00	00 - FF : ASCII code				
2030	00	00 - FF : ASCII code				
2031	00	00 - FF : ASCII code				
2032	00	00 - FF : ASCII code				
2033	00	00 - FF : ASCII code				





Item	Sub item	Address (hex)	Size (dec)	Default (hex)	Setting value (hex)	Remarks	
Command alias	Start symbol read command[3]	2034	16	00	00 - FF : ASCII code		
		2035		00	00 - FF : ASCII code		
		2036		00	00 - FF : ASCII code		
		2037		00	00 - FF : ASCII code		
		2038		00	00 - FF : ASCII code		
		2039		00	00 - FF : ASCII code		
		203A		00	00 - FF : ASCII code		
		203B		00	00 - FF : ASCII code		
		203C		00	00 - FF : ASCII code		
		203D		00	00 - FF : ASCII code		
		203E		00	00 - FF : ASCII code		
		203F		00	00 - FF : ASCII code		
		2040		00	00 - FF : ASCII code		
		2041		00	00 - FF : ASCII code		
		2042		00	00 - FF : ASCII code		
		2043		00	00 - FF : ASCII code		
	Stop symbol read command[0]	Stop symbol read command[0]	2044	16	4C		00 - FF : ASCII code
			2045		4F		00 - FF : ASCII code
			2046		46		00 - FF : ASCII code
			2047		46		00 - FF : ASCII code
			2048		0D		00 - FF : ASCII code
			2049		00		00 - FF : ASCII code
			204A		00		00 - FF : ASCII code
			204B		00		00 - FF : ASCII code
			204C		00		00 - FF : ASCII code
			204D		00		00 - FF : ASCII code
			204E		00		00 - FF : ASCII code
			204F		00		00 - FF : ASCII code
			2050		00		00 - FF : ASCII code
			2051		00		00 - FF : ASCII code
			2052		00		00 - FF : ASCII code
			2053		00		00 - FF : ASCII code
	Stop symbol read command[1]	Stop symbol read command[1]	2054	16	1B		00 - FF : ASCII code
			2055		59		00 - FF : ASCII code
			2056		0D		00 - FF : ASCII code
			2057		00		00 - FF : ASCII code
			2058		00		00 - FF : ASCII code
			2059		00		00 - FF : ASCII code
			205A		00		00 - FF : ASCII code
			205B		00		00 - FF : ASCII code
			205C		00		00 - FF : ASCII code
			205D		00		00 - FF : ASCII code
			205E		00		00 - FF : ASCII code
			205F		00		00 - FF : ASCII code
			2060		00		00 - FF : ASCII code
			2061		00		00 - FF : ASCII code
			2062		00		00 - FF : ASCII code
			2063		00		00 - FF : ASCII code

Item	Sub item	Address (hex)	Size (dec)	Default (hex)	Setting value (hex)	Remarks
Command alias	Stop symbol read command[2]	2064	16	53	00 - FF : ASCII code	
		2065		00	00 - FF : ASCII code	
		2066		00	00 - FF : ASCII code	
		2067		00	00 - FF : ASCII code	
		2068		00	00 - FF : ASCII code	
		2069		00	00 - FF : ASCII code	
		206A		00	00 - FF : ASCII code	
		206B		00	00 - FF : ASCII code	
		206C		00	00 - FF : ASCII code	
		206D		00	00 - FF : ASCII code	
		206E		00	00 - FF : ASCII code	
		206F		00	00 - FF : ASCII code	
		2070		00	00 - FF : ASCII code	
		2071		00	00 - FF : ASCII code	
		2072		00	00 - FF : ASCII code	
		2073		00	00 - FF : ASCII code	
	Stop symbol read command[3]	2074	16	00	00 - FF : ASCII code	
		2075		00	00 - FF : ASCII code	
		2076		00	00 - FF : ASCII code	
		2077		00	00 - FF : ASCII code	
		2078		00	00 - FF : ASCII code	
		2079		00	00 - FF : ASCII code	
		207A		00	00 - FF : ASCII code	
		207B		00	00 - FF : ASCII code	
		207C		00	00 - FF : ASCII code	
		207D		00	00 - FF : ASCII code	
		207E		00	00 - FF : ASCII code	
		207F		00	00 - FF : ASCII code	
		2080		00	00 - FF : ASCII code	
		2081		00	00 - FF : ASCII code	
		2082		00	00 - FF : ASCII code	
		2083		00	00 - FF : ASCII code	
	Reserved	2084-20FF	124	-	-	
	Communication command Function	Reserved	2100	1	-	
Check digit addition		2101	1	00	00 : Disabled 01 : Enabled	Not applied to control command requests.
Uppercase response		2102	1	00	00 : Disabled (lowercase) 01 : Enabled (uppercase)	You can select the notation for the hexadecimal data when there is a response.
Reserved		2103	1	-	-	
Prefix		2104	4	5E	00 - FF : ASCII code	
		2105		00	00 - FF : ASCII code	
		2106		00	00 - FF : ASCII code	
		2107		00	00 - FF : ASCII code	
Suffix		2108	4	0D	00 - FF : ASCII code	
		2109		0A	00 - FF : ASCII code	
		210A		00	00 - FF : ASCII code	
		210B		00	00 - FF : ASCII code	
Reserved	210C-21FF	244	-	-		
PLC Connection	Function enabled	2200	1	00	00 : Disabled 01 : Enabled	If enabled, it will begin the process to establish a connection with connected external devices at start up. New settings will be reflected after saving and resetting the device.

Item	Sub item	Address (hex)	Size (dec)	Default (hex)	Setting value (hex)	Remarks	
PLC Connection	Protocol Select	2201	1	00	00 : MC Protocol Format4 4C(QL Series)	Select the communication protocol of the external device that is to be connected to the WB2F	
	Monitoring cycle	2202	1	0A	01 - FF : Setting value by 10m step (10ms to 2,550ms)	Configure the monitoring interval for the special area	
	Timeout	2203	1	14	01 - FF : Setting value by 10m step (10ms to 2,550ms)	Configures response timeout from a PLC	
	Retry Count	2204	1	05	01 - FF : Times	Sets the number of command retransmissions to a PLC	
	Symbol data storage endian	2205	1	00	00 : Lower→Upper 01 : Upper→Lower	To configure the order of stocked data in data memory of PLC.	
	Reserved	2206	1	00	-		
	Reserved	2207	1	00	-		
	Special Area Start Address		2208	4	00	00000000 - FFFFFFFF : Special Area Start Address	When configuring the settings ensure that the special area and the scanner information area do not overlap. The special area requires 4 words (8 bytes) of data memory.
			2209		00		
			220A		00		
			220B		00		
	Scanner Information Area Start Address		220C	4	10	00000000 - FFFFFFFF : Scanner Information Area Start Address	
			220D		00		
			220E		00		
			220F		00		
	Reserved	2210-221F	16	00	-		
	Protocol Parameter[0]		2220	2	0000	0000 - FFFF : Protocol Parameter	
			2221		0000		
	Protocol Parameter[1]		2222	2	0000	0000 - FFFF : Protocol Parameter	
			2223		0000		
	Protocol Parameter[2]		2224	2	0000	0000 - FFFF : Protocol Parameter	
			2225		0000		
	Protocol Parameter[3]		2226	2	0000	0000 - FFFF : Protocol Parameter	
			2227		0000		
	Protocol Parameter[4]		2228	2	0000	0000 - FFFF : Protocol Parameter	
			2229		0000		
	Protocol Parameter[5]		222A	2	0000	0000 - FFFF : Protocol Parameter	
			222B		0000		
	Protocol Parameter[6]		222C	2	0000	0000 - FFFF : Protocol Parameter	
			222D		0000		
	Protocol Parameter[7]		222E	2	0000	0000 - FFFF : Protocol Parameter	
			222F		0000		
	Protocol Parameter[8]		2230	2	0000	0000 - FFFF : Protocol Parameter	
			2231		0000		
Protocol Parameter[9]		2232	2	0000	0000 - FFFF : Protocol Parameter		
		2233		0000			
Protocol Parameter[10]		2234	2	0000	0000 - FFFF : Protocol Parameter		
		2235		0000			
Protocol Parameter[11]		2236	2	0000	0000 - FFFF : Protocol Parameter		
		2237		0000			
Protocol Parameter[12]		2238	2	0000	0000 - FFFF : Protocol Parameter		
		2239		0000			
Protocol Parameter[13]		223A	2	0000	0000 - FFFF : Protocol Parameter		
		223B		0000			
Protocol Parameter[14]		223C	2	0000	0000 - FFFF : Protocol Parameter		
		223D		0000			
Protocol Parameter[15]		223E	2	0000	0000 - FFFF : Protocol Parameter		
		223F		0000			
Reserved	2240-22FF	192	-	-			



Item	Sub item	Address (hex)	Size (dec)	Default (hex)	Setting value (hex)	Remarks	
Reserved		2300-33FF	4352	-	-		
Reserved		3400-340E	15	-	-		
Decoder common	All symbology Reading allowed/prohibited	340F	1	*	00 : All symbology reading prohibited 01 : All symbology reading allowed	All parameter table setting values can be rewritten in a lump. * The value FFH is returned any time setting values are acquired	
Reserved		3410	1	-	-		
Reserved		3411	1	-	-		
Decoder Code39	Inspection of check digit	3412	1	00	00 : Disabled 01 : Enabled		
	Check digit transmitting	3413	1	01	00 : Not transmit 01 : Transmit		
	Margin rate	3414	1	00	00 : Normal 01 - 06 : 1/7-6/7		
	Reserved		3415	1	-	-	
	Start/stop character transmitting	3416	1	00	00 : Disabled 01 : Enabled		
	Reserved		3417	1	-	-	
	Full ASCII decode	3418	1	00	00 : Not convert 01 : Convert 02 : Not read anything other than full ASCII		
	Reserved		3419-341D	5	-	-	
	Fixed length A	341E	1	02	01 - 40 : (1 digit to 64 digits)	For details, refer to  [Methods to fix the length of read symbols] on page 4-89.	
	Fixed length B	341F	1	40	01 - 40 : (1 digit to 64 digits)		
	Reserved		3420	1	-	-	
Reserved		3421	1	-	-		
Decoder Codabar (NW7)	Inspection of check digit	3422	1	00	00 : Disabled 01 : Enabled		
	Check digit transmitting	3423	1	01	00 : Not transmit 01 : Transmit		
	Margin rate	3424	1	00	00 : Normal 01 - 06 : 1/7-6/7		
	Reserved		3425	1	-	-	
	Start/stop character transmitting	3426	1	01	00 : Disabled 01 : Enabled		
	Reserved		3427	1	-	-	
	Start/stop type	3428	1	00	00 : ABCD/ABCD 01 : abcd/abcd 02 : ABCD/TN*E 03 : abcd/tn*e 04 : DC1-4/DC1-4		
	Start/stop identical check	3429	1	00	00 : Disabled 01 : Enabled		



Item	Sub item	Address (hex)	Size (dec)	Default (hex)	Setting value (hex)	Remarks
Decoder Codabar (NW7)	Check digit type selection	342A	1	00	00 : Modulus 16 (AIM compliant) 01 : Modulus 11 weight pattern 1 02 : Modulus 11 weight pattern 2 03 : Modulus 10 weight 1, 2 04 : Modulus 10 weight 1, 2 (Luhn) 05 : Modulus 10 weight 3 06 : 7Check	
	CLSI editing	342B	1	00	00 : Disabled 01 : Enabled	
	Linked code format	342C	1	00	00 : No Link 01 : ABC format 02 : CX format	
	Reserved	342D	1	-	-	
	Fixed length A	342E	1	04	01 - 40 : (1 digit to 64 digits)	For details, refer to  [Methods to fix the length of read symbols] on page 4-89.
	Fixed length B	342F	1	40	01 - 40 : (1 digit to 64 digits)	
Decoder Interleaved 2of5	Reserved	3430	1	-	-	
	Reserved	3431	1	-	-	
	Inspection of check digit	3432	1	00	00 : Disabled 01 : Enabled	
	Check digit transmitting	3433	1	01	00 : Not transmit 01 : Transmit	
	Margin rate	3434	1	00	00 : Normal 01 - 06 : 1/7 - 6/7	
	Reserved	3435-3439	5	-	-	
	Check digit type selection	343A	1	00	00 : USS 01 : OPCC	
	EAN-13 conversion	343B	1	00	00 : Disabled 01 : Enabled	
	Reserved	343C	1	-	-	
	Reserved	343D	1	-	-	
	Fixed length A	343E	1	06	01 - 40 : (1 digit to 64 digits)	For details, refer to  [Methods to fix the length of read symbols] on page 4-89.
Fixed length B	343F	1	40	01 - 40 : (1 digit to 64 digits)		
Decoder Standard 2of5	Reserved	3440	1	-	-	
	Reserved	3441	1	-	-	
	Inspection of check digit	3442	1	00	00 : Disabled 01 : Enabled	
	Check digit transmitting	3443	1	01	00 : Not transmit 01 : Transmit	
	Margin rate	3444	1	00	00 : Normal 01 - 06 : 1/7 - 6/7	
	Reserved	3445	1	-	-	
	Reserved	3446	1	-	-	
	Inter-character gap check	3447	1	00	00 : Disabled 01 : Enabled	
	Reserved	3448-344D	6	-	-	
	Fixed length A	344E	1	05	01 - 40 : (1 digit to 64 digits)	
Fixed length B	344F	1	40	01 - 40 : (1 digit to 64 digits)		



Item	Sub item	Address (hex)	Size (dec)	Default (hex)	Setting value (hex)	Remarks
Decoder Matrix 2of5	Reserved	3450	1	-	-	
	Reserved	3451	1	-	-	
	Inspection of check digit	3452	1	00	00 : Disabled 01 : Enabled	
	Check digit transmitting	3453	1	01	00 : Not transmit 01 : Transmit	
	Margin rate	3454	1	00	00 : Normal 01 - 06 : 1/7 - 6/7	
	Reserved	3455-345D	9	-	-	
	Fixed length A	345E	1	05	01 - 40 : (1 digit to 64 digits)	For details, refer to  [Methods to fix the length of read symbols] on page 4-89.
	Fixed length B	345F	1	40	01 - 40 : (1 digit to 64 digits)	
Decoder IATA 2of5	Reserved	3460	1	-	-	
	Reserved	3461	1	-	-	
	Inspection of check digit	3462	1	00	00 : Disabled 01 : Enabled	
	Check digit transmitting	3463	1	01	00 : Not transmit 01 : Transmit	
	Margin rate	3464	1	00	00 : Normal 01 - 06 : 1/7 - 6/7	
	Reserved	3465-346D	9	-	-	
	Fixed length A	346E	1	05	01 - 40 : (1 digit to 64 digits)	For details, refer to  [Methods to fix the length of read symbols] on page 4-89.
	Fixed length B	346F	1	40	01 - 40 : (1 digit to 64 digits)	
Decoder COOP 2of5	Reserved	3470	1	-	-	
	Reserved	3471	1	-	-	
	Inspection of check digit	3472	1	00	00 : Disabled 01 : Enabled	
	Check digit transmitting	3473	1	01	00 : Not transmit 01 : Transmit	
	Margin rate	3474	1	00	00 : Normal 01 - 06 : 1/7 - 6/7	
	Reserved	3475-347D	9	-	-	
	Fixed length A	347E	1	04	01 - 40 : (1 digit to 64 digits)	For details, refer to  [Methods to fix the length of read symbols] on page 4-89.
	Fixed length B	347F	1	40	01 - 40 : (1 digit to 64 digits)	
Decoder Scode	Reserved	3480	1	-	-	
	Reserved	3481	1	-	-	
	Inspection of check digit	3482	1	00	00 : Disabled 01 : Enabled	
	Check digit transmitting	3483	1	01	00 : Not transmit 01 : Transmit	
	Margin rate	3484	1	00	00 : Normal 01 - 06 : 1/7 - 6/7	
	Reserved	3485-348C	8	-	-	
	Interleaved 2of5 format conversion	348D	1	00	00 : Disabled 01 : Enabled	
	Fixed length A	348E	1	02	01 - 40 : (1 digit to 64 digits)	For details, refer to  [Methods to fix the length of read symbols] on page 4-89.
	Fixed length B	348F	1	40	01 - 40 : (1 digit to 64 digits)	





Item	Sub item	Address (hex)	Size (dec)	Default (hex)	Setting value (hex)	Remarks
Decoder Chinese Post Matrix	Reserved	3490	1	-	-	
	Reserved	3491	1	-	-	
	Inspection of check digit	3492	1	00	00 : Disabled 01 : Enabled	
	Check digit transmitting	3493	1	01	00 : Not transmit 01 : Transmit	
	Margin rate	3494	1	00	00 : Normal 01 - 06 : 1/7 - 6/7	
	Reserved	3495-349D	9	-	-	
	Fixed length A	349E	1	05	01 - 40 : (1 digit to 64 digits)	For details, refer to  [Methods to fix the length of read symbols] on page 4-89.
	Fixed length B	349F	1	40	01 - 40 : (1 digit to 64 digits)	
Decoder UPC-A	Reserved	34A0	1	-	-	
	Reserved	34A1	1	-	-	
	Inspection of check digit	34A2	1	01	00 : Disabled 01 : Enabled	
	Check digit transmitting	34A3	1	01	00 : Not transmit 01 : Transmit	
	Margin rate	34A4	1	00	00 : Normal 01 - 06 : 1/7 - 6/7	
	Reserved	34A5	1	-	-	
	Reading with supplement	34A6	1	00	00 : Prohibited 01 : 2 digits only 02 : 5 digits only 03 : 2 digits/5 digits	
	Transmitting "0" at the beginning	34A7	1	01	00 : Not transmit 01 : Transmit	
	EAN-13 conversion	34A8	1	00	00 : Disabled 01 : Enabled	
	Reserved	34A9-34AF	7	-	-	
Decoder UPC-E0	Reserved	34B0	1	-	-	
	Reserved	34B1	1	-	-	
	Inspection of check digit	34B2	1	01	00 : Disabled 01 : Enabled	
	Check digit transmitting	34B3	1	01	00 : Not transmit 01 : Transmit	
	Margin rate	34B4	1	00	00 : Normal 01 - 06 : 1/7 - 6/7	Common settings with UPC-E1
	Reserved	34B5	1	-	-	
	Reading with supplement	34B6	1	00	00 : Prohibited 01 : 2 digits only 02 : 5 digits only 03 : 2 digits/5 digits	
	Number system characters	34B7	1	01	00 : Not transmit 01 : Transmit	
	EAN-13 conversion	34B8	1	00	00 : Disabled 01 : Enabled	
	UPC-A conversion	34B9	1	00	00 : Disabled 01 : Enabled	
	Reserved	34BA-34BF	6	-	-	

Item	Sub item	Address (hex)	Size (dec)	Default (hex)	Setting value (hex)	Remarks	
Decoder UPC-E1	Reserved	34C0	1	-	-		
	Reserved	34C1	1	-	-		
	Inspection of check digit	34C2	1	01	00 : Disabled 01 : Enabled		
	Check digit transmitting	34C3	1	01	00 : Not transmit 01 : Transmit		
	Reserved	34C4	1	-	-		
	Reserved	34C5	1	-	-		
	Reading with supplement	34C6	1	00	00 : Prohibited 01 : 2 digits only 02 : 5 digits only 03 : 2 digits/5 digits		
	Number system characters	34C7	1	01	00 : Not transmit 01 : Transmit		
	EAN-13 conversion	34C8	1	00	00 : Disabled 01 : Enabled		
	UPC-A conversion	34C9	1	00	00 : Disabled 01 : Enabled		
	Reserved	34CA-34CF	6	-	-		
	Decoder EAN-13	Reserved	34D0	1	-	-	
		Reserved	34D1	1	-	-	
Inspection of check digit		34D2	1	01	00 : Disabled 01 : Enabled		
Check digit transmitting		34D3	1	01	00 : Not transmit 01 : Transmit		
Margin rate		34D4	1	00	00 : Normal 01 - 06 : 1/7 - 6/7		
Reserved		34D5	1	-	-		
Reading with supplement		34D6	1	00	00 : Prohibited 01 : 2 digits only 02 : 5 digits only 03 : 2 digits/5 digits		
Active supplement/ Japan 491: (periodical code)		34D7	1	00	00 : Disabled 01 : Enabled		
Active supplement/ ISSN 977		34D8	1	00	00 : Disabled 01 : Enabled		
Active supplement/ bookland 978,979		34D9	1	00	00 : Disabled 01 : Enabled		
Active supplement/ France 378/379		34DA	1	00	00 : Disabled 01 : Enabled		
Active supplement/ Germany 414,419,434,439		34DB	1	00	00 : Disabled 01 : Enabled		
ISBN option		34DC	1	00	00 : Disabled 01 : Read only ISBN 02 : Output all including non-ISBN		
ISSN option		34DD	1	00	00 : Disabled 01 : Read only ISSN 02 : Output all including non-ISSN		
ISMN option		34DE	1	00	00 : Disabled 01 : Read only ISBM 02 : Output all including non-ISBM		
Japanese book 2 step code		34DF	1	00	00 : Disabled 01 : Enabled		

Item	Sub item	Address (hex)	Size (dec)	Default (hex)	Setting value (hex)	Remarks
Decoder EAN-8	Reserved	34E0	1	-	-	
	Reserved	34E1	1	-	-	
	Inspection of check digit	34E2	1	01	00 : Disabled 01 : Enabled	
	Check digit transmitting	34E3	1	01	00 : Not transmit 01 : Transmit	
	Margin rate	34E4	1	00	00 : Normal 01 - 06 : 1/7 - 6/7	
	Reserved	34E5	1	-	-	
	Reading with supplement	34E6	1	00	00 : Prohibited 01 : 2 digits only 02 : 5 digits only 03 : 2 digits/5 digits	
	EAN-13 conversion	34E7	1	00	00 : Disabled 01 : Enabled	
	Reserved	34E8-34F1	8	-	-	
Decoder Code128	Reserved	34F0	1	-	-	
	Reserved	34F1	1	-	-	
	Inspection of check digit	34F2	1	01	00 : Disabled 01 : Enabled	
	Reserved	34F3	1	-	-	
	Margin rate	34F4	1	00	00 : Normal 01 - 06 : 1/7-6/7	
	Reserved	34F5-34FD	9	-	-	
	Fixed length A	34FE	1	01	01 - 40 : (1 digit to 64 digits)	For details, refer to  [Methods to fix the length of read symbols] on page 4-89.
	Fixed length B	34FF	1	40	01 - 40 : (1 digit to 64 digits)	
Decoder GS1-128	Reserved	3500	1	-	-	
	Reserved	3501	1	-	-	
	Output mode	3502	1	00	00 : Normal 01 : AI recognition mode	Output mode is enabled during AI recognition mode
	FNC1/GS conversion	3503	1	01	00 : Disabled 01 : Enabled	
	AI output	3504	1	01	00 : Disabled 01 : Enabled	
	AI parenthesis additional output	3505	1	00	00 : Disabled 01 : Enabled	
	Date data zero suppression	3506	1	00	00 : Disabled 01 : Enabled	
	Decimal point insertion	3507	1	00	00 : Disabled 01 : Enabled	
	Reserved	3508-350D	6	-	-	
	Fixed length A	350E	1	03	01 - 40 : (1 digit to 64 digits)	For details, refer to  [Methods to fix the length of read symbols] on page 4-89.
	Fixed length B	350F	1	40	01 - 40 : (1 digit to 64 digits)	

Item	Sub item	Address (hex)	Size (dec)	Default (hex)	Setting value (hex)	Remarks
Decoder Code93	Reserved	3510	1	-	-	
	Reserved	3511	1	-	-	
	Inspection of check digit	3512	1	01	00 : Disabled 01 : Enabled	
	Reserved	3513	1	-	-	
	Margin rate	3514	1	00	00 : Normal 01 - 06 : 1/7 - 6/7	
	Reserved	3515-351D	9	-	-	
	Fixed length A	351E	1	01	01 - 40 : (1 digit to 64 digits)	For details, refer to  [Methods to fix the length of read symbols] on page 4-89.
	Fixed length B	351F	1	40	01 - 40 : (1 digit to 64 digits)	
Decoder MSI/Plessey	Reserved	3520	1	-	-	
	Reserved	3521	1	-	-	
	Inspection of check digit	3522	1	00	00 : Disabled 01 : Enabled	
	Check digit transmitting	3523	1	02	00 : Not transmit 01 : 1 digit transmit 02 : 2 digits transmit	
	Margin rate	3524	1	00	00 : Normal 01 - 06 : 1/7 - 6/7	
	Reserved	3525	5	-	-	
	Check digit type selection	352A	1	00	00 : MOD10 01 : MOD10+MOD10 02 : MOD10+MOD11 03 : MOD11+MOD10	
	Reserved	352B	1	-	-	
	Reserved	352C	1	-	-	
	Reserved	352D	1	-	-	
	Fixed length A	352E	1	03	01 - 40 : (1 digit to 64 digits)	For details, refer to  [Methods to fix the length of read symbols] on page 4-89.
Fixed length B	352F	1	40	01 - 40 : (1 digit to 64 digits)		
Decoder Italian Pharmacy (Code32)	Reserved	3530	1	-	-	
	Reserved	3531	1	-	-	
	Inspection of check digit	3532	1	00	00 : Disabled 01 : Enabled	
	Check digit transmitting	3533	1	01	00 : Not transmit 01 : Transmit	
	Reserved	3534	1	-	-	
	Transmit prefix A	3535	1	00	00 : Disabled 01 : Enabled	
	Reserved	3536-353F	10	-	-	
Decoder CIP39	Reserved	3540	1	-	-	
	Reserved	3541	1	-	-	
	Inspection of check digit	3542	1	00	00 : Disabled 01 : Enabled	
	Check digit transmitting	3543	1	01	00 : Not transmit 01 : Transmit	
	Reserved	3544	1	-	-	
	Reserved	3545	1	-	-	
	Start/stop character transmitting	3546	1	00	00 : Not transmit 01 : Transmit	
	Reserved	3547-354F	9	-	-	
Decoder Tri-Optic	Reserved	3550-3555	6	-	-	
	Start/stop character transmitting	3556	1	00	00 : Not transmit 01 : Transmit	
	Reserved	3557-355F	9	-	-	

Item	Sub item	Address (hex)	Size (dec)	Default (hex)	Setting value (hex)	Remarks
Decoder TELEPEN	Reserved	3560	1	-	-	
	Reserved	3561	1	-	-	
	Inspection of check digit	3562	1	01	00 : Disabled 01 : Enabled	
	Check digit transmitting	3563	1	00	00 : Not send 01 : Send	
	Reserved	3564	1	-	-	
	Reserved	3565	1	-	-	
	Reserved	3566	1	-	-	
	ASCII mode	3567	1	00	00 : Disabled 01 : Enabled	
	Reserved	3568	1	-	-	
	VTF conversion	3569	1	00	00 : Disabled 01 : Enabled	
	SISO conversion	356A	1	00	00 : Disabled 01 : Enabled	
	Reserved	356B	1	-	-	
	Reserved	356C	1	-	-	
	Reserved	356D	1	-	-	
		Fixed length A	356E	1	03	01 - 1E : (1 digit to 64 digits)
	Fixed length B	356F	1	1E	01 - 1E : (1 digit to 64 digits)	
Decoder Code11	Reserved	3570	1	-	-	
	Reserved	3571	1	-	-	
	Inspection of check digit	3572	1	01	00 : Disabled 01 : Enabled	
	Check digit transmitting	3573	1	01	00 : Not transmit 01 : Transmit	
	End Margin Rate	3574	1	00	00 : Normal 01 - 06 : 1/7-6/7	
	Reserved	3575-3579	5	-	-	
	Check digit type selection	357A	1	00	00 : Auto: Less than 10 characters TypeC 01 : TypeC (1 digit) 02 : TypeK (1 digit) 03 : TypeC+K	
	Reserved	357B	1	-	-	
	Reserved	357C	1	-	-	
	Reserved	357D	1	-	-	
	Fixed length A	357E	1	02	01 - 40 : (1 digit to 64 digits)	For details, refer to  [Methods to fix the length of read symbols] on page 4-89.
	Fixed length B	357F	1	40	01 - 40 : (1 digit to 64 digits)	
Decoder GS1 Databar Expanded	Reserved	3580-358D	14	-	-	
	Fixed length A	358E	1	01	01 - 40 : (1 digit to 64 digits)	For details, refer to  [Methods to fix the length of read symbols] on page 4-89.
	Fixed length B	358F	1	40	01 - 40 : (1 digit to 64 digits)	
Reserved	3590-35AF	32	-	-		
Decoder GS1 Databar Expanded stacked	Reserved	35B0-35BD	14	-	-	
	Fixed length A	35BE	1	02	01 - 4D : (1 digit to 77 digits)	For details, refer to  [Methods to fix the length of read symbols] on page 4-89.
	Fixed length B	35BF	1	4D	01 - 4D : (1 digit to 77 digits)	
Reserved	35C0-35FF	64	-	-		

Item	Sub item	Address (hex)	Size (dec)	Default (hex)	Setting value (hex)	Remarks
Decoder PDF417	Reserved	3600-360B	12	-	-	
	Fixed length A	360C	2	01	01 - 0A9C : (1 digit to 2,716 digits)	For details, refer to  [Methods to fix the length of read symbols] on page 4-89.
		360D				
	Fixed length B	360E	2	0A9C	01 - 0A9C : (1 digit to 2,716 digits)	
360F						
Decoder Micro PDF417	Reserved	3610-3614	5	-	-	
	Code128 Emulation Mode	3615	1	01	00 : Disabled 01 : Enabled	
	Reserved	3616-361B	6	-	-	
	Fixed length A	361C	2	0001	01 - 016E : (1 digit to 366 digits)	For details, refer to  [Methods to fix the length of read symbols] on page 4-89.
		361D				
	Fixed length B	361E	2	016E	01 - 0A9C : (1 digit to 366 digits)	
361F						
Decoder Data Matrix	Reserved	3620-3624	5	-	-	
	Rectangular code	3625	1	01	00 : Disabled 01 : Enabled	
	Mirror inversion code	3626	1	00	00 : Disabled 01 : Enabled	
	Reserved	3627-362B	5	-	-	
	Fixed length A	362C	2	0001	01 - 0C2C : (1 digit to 3,116 digits)	For details, refer to  [Methods to fix the length of read symbols] on page 4-89.
		362D				
Fixed length B	362E	2	0C2C	01 - 0C2C : (1 digit to 3,116 digits)		
	362F					
Decoder QR Code	Reserved	3630-363B	12	-	-	
	Fixed length A	363C	2	0001	01 - 1BB1 : (1 digit to 7,089 digits)	For details, refer to  [Methods to fix the length of read symbols] on page 4-89.
		363D				
	Fixed length B	363E	2	1BB1	(1 digit to 7,089 digits)	
363F						
Decoder Micro QR Code	Reserved	3640-364B	12	-	-	
	Fixed length A	364C	2	0001	01 - 0023 : (1 digit to 35 digits)	For details, refer to  [Methods to fix the length of read symbols] on page 4-89.
		364D				
	Fixed length B	364E	2	0023	01 - 0023 : (1 digit to 35 digits)	
364F						
Reserved	3650-367F	48	-	-		
Decoder COMPOSITE CC-A/CC-B/CC-C	Reserved	3680	1	-	-	
	Reserved	3681	1	-	-	
	Reserved	3682	1	-	-	
	Micro PDF417 (CC-A/B)Output	3683	1	02	01 :If unable to read the barcode, output Micro PDF417 data 02 : Output only if both are read	
	PDF417 (CC-C)Outlook	3684	1	02	01 : If unable to read the barcode, output PDF417 data 02 : Output only if both are read	
	GS1DataBar Output	3685	1	02	00 : Disable reading of GS1 Databar Composite 01 : If unable to read PDF417/ Micro PDF417, output barcode data 02 :Output only if both are read	

Item	Sub item	Address (hex)	Size (dec)	Default (hex)	Setting value (hex)	Remarks
Decoder COMPOSITE CC-A/CC-B/CC-C	GS1-128 Output	3686	1	02	00 : Disable reading of GS1-128 Composite 01 : If unable to read PDF417/Micro PDF417, output barcode data 02 : Output only if both are read	
	WPC Output	3687	1	01	00 : Disable reading of WPC Composite 01 : If unable to read PDF417/Micro PDF417, output barcode data	
	Reserved	3688-368F	8	-	-	
Decoder Japan Postal	Reserved	3690-369D	14	-	-	
	Fixed length A	369E	1	07	07 - 14 : (7 digits to 20 digits)	For details, refer to  [Methods to fix the length of read symbols] on page 4-89.
	Fixed length B	369F	1	14	07 - 14 : (7 digits to 20 digits)	
Reserved		36A0-FFFF	51680	-	-	

Methods to fix the length of read symbols

Fixed Length A and Fixed Length B setting configurations are only available for applicable symbols

There are three methods to fix the length.

Fixed length method	Configuration method	Readable length
Specify range	Fixed length A < fixed length B	Fixed length A to fixed length B
Specify fixed length	Fixed length A ≥ fixed length B	Fixed length A, fixed length B
Not specified	Fixed length A=00H	Minimum value to maximum value (varies by symbol)

■ Specified Range

You can specify a range for the length by setting the minimum symbol length to read for fixed length A and setting the maximum for fixed length B (fixed length A < fixed length B). However, do not set fixed length A as "00H". A range cannot be specified in that way.

e.g. When fixed length A is set to "02H" and fixed length B is set to "08H"

If Fixed Length A < Fixed Length B, only symbols with a range of 2 to 8 characters can be read

■ Specify fixed length

If the setting value for fixed length A is larger than that of fixed length B (fixed length A > fixed length B), two types of fixed lengths can be set. If fixed length B is "00H", only the length set by fixed length A can be read.

If fixed length A and fixed length B are set to the same value (fixed length A=fixed length B), only the fixed length that has been set can be read.

e.g. When fixed length A is set to "08H" and fixed length B is set to "02H"

If Fixed Length A > Fixed Length B, only symbols with a range of 2 to 8 will be read.

e.g. When fixed length A is set to "05H" and fixed length B is set to "05H"

If Fixed Length A = Fixed Length B, only symbols with 5 characters can be read.

■ Fixed length not specified

If Fixed Length A is set to 00H, no fixed range is set for the value of fixed length. Any symbol with a range of minimum to maximum (depending on the symbol) number of characters can be read.

e.g. When fixed length A is set to "00H"

If Fixed Length A = 00H, any symbol with a range of minimum to maximum (varies depending on the symbol) number of characters can be read



Confirm each symbols decoding settings for the readable Number of Characters (minimum value, maximum value)

The factory default setting is a specified length range that defines the minimum length. The factory default fixed length settings are as follows.

Symbol Type	Fixed length A (Minimum length)	Fixed length B (Maximum length)	Note
Code39	2	64	Not including the start/stop character.
Codabar(NW7)	4		
Interleaved 2of5	6		
Standard 2of5	5		
Matrix 2of5	5		
IATA 2of5(IATA)	5		
COOP 2of5	4		
SCODE	2		
Chinese Post Matrix	5		
UPC-A	–	–	Cannot adjust settings, length is fixed.
UPC-E0	–	–	
UPC-E1	–	–	
EAN-13	–	–	
EAN-8	–	–	
Code128	1	64	Not including FNC1.
GS1-128	3		
Code93	1		
MSI/Plessey	3		
Italian Pharm(Code32)	–	–	Cannot adjust settings, length is fixed.
CIP39	–	–	
Tri-Optic	–	–	
TELEPEN	3	30	The length in NUMERIC mode is 1/2. Not including the check digit
Code11	2	64	Cannot adjust settings, length is fixed.
GS1 Databar Expanded	1		
GS1 Databar Limited	–	–	Cannot adjust settings, length is fixed.
GS1 Databar	–	–	
GS1 Databar Expanded stack	2	77	
GS1 Databar stack	–	–	
PDF417	1	2,716	
Micro PDF417	1	366	
Data Matrix	1	3,116	
QR Code	1	7,089	
Micro QR Code	1	35	
Composite	–	–	
Japan postal	7	20	

Parameter Table Address Table

Details on the parameter table address are as follows

Major Item	sub item	Table0 Address	Table1 Address	Table2 Address	Table3 Address	Table4 Address	Table5 Address	Table6 Address	Table7 Address
		HEX	HEX	HEX	HEX	HEX	HEX	HEX	HEX
Parameter Changeover Function	Reserved	0300	0360	03C0	0420	0480	04E0	0540	05A0
	Reserved	0301	0361	03C1	0421	0481	04E1	0541	05A1
	Analog Gain	0302	0362	03C2	0422	0482	04E2	0542	05A2
	Digital Gain	0303	0363	03C3	0423	0483	04E3	0543	05A3
	Exposure Time	0304	0364	03C4	0424	0484	04E4	0544	05A4
		0305	0365	03C5	0425	0485	04E5	0545	05A5
	Decode Range X Start Coordinates	0306	0366	03C6	0426	0486	04E6	0546	05A6
	Decode Range Y Start Coordinates	0307	0367	03C7	0427	0487	04E7	0547	05A7
		0308	0368	03C8	0428	0488	04E8	0548	05A8
	Decode Range X Stop Coordinates	0309	0369	03C9	0429	0489	04E9	0549	05A9
		030A	036A	03CA	042A	048A	04EA	054A	05AA
	Decode Range Y Stop Coordinates	030B	036B	03CB	042B	048B	04EB	054B	05AB
		030C	036C	03CC	042C	048C	04EC	054C	05AC
	White Black Reversal Settings	030D	036D	03CD	042D	048D	04ED	054D	05AD
		030E	036E	03CE	042E	048E	04EE	054E	05AE
	Decoder Mode	030F	036F	03CF	042F	048F	04EF	054F	05AF
	Filter Setting 1st time	0310	0370	03D0	0430	0490	04F0	0550	05B0
	Filter Setting 2nd time	0311	0371	03D1	0431	0491	04F1	0551	05B1
	Filter Setting 3rd time	0312	0372	03D2	0432	0492	04F2	0552	05B2
	Filter setting 4th time	0313	0373	03D3	0433	0493	04F3	0553	05B3
	Reserved	0314	0374	03D4	0434	0494	04F4	0554	05B4
	Code39 Enable Setting	0315	0375	03D5	0435	0495	04F5	0555	05B5
	Codabar(r NW7) Enable Setting	0316	0376	03D6	0436	0496	04F6	0556	05B6
	Interleaved 2of5 Enable Setting	0317	0377	03D7	0437	0497	04F7	0557	05B7
	Standard 2of5 Enable Setting	0318	0378	03D8	0438	0498	04F8	0558	05B8
	Matrix 2of5 Enable Setting	0319	0379	03D9	0439	0499	04F9	0559	05B9
	IATA 2of5 Enable Setting	031A	037A	03DA	043A	049A	04FA	055A	05BA
	Coop 2of5 Enable Setting	031B	037B	03DB	043B	049B	04FB	055B	05BB
	Scode Enable Setting	031C	037C	03DC	043C	049C	04FC	055C	05BC
	Chinese Post Matrix Enable Setting	031D	037D	03DD	043D	049D	04FD	055D	05BD
	UPC-A Enable Setting	031E	037E	03DE	043E	049E	04FE	055E	05BE
	UPC-E0 Enable Setting	031F	037F	03DF	043F	049F	04FF	055F	05BF
	UPC-E1 Enable Setting	0320	0380	03E0	0440	04A0	0500	0560	05C0
EAN-13 Enable Setting	0321	0381	03E1	0441	04A1	0501	0561	05C1	
EAN-8 Enable Setting	0322	0382	03E2	0442	04A2	0502	0562	05C2	
Code128 Enable Setting	0323	0383	03E3	0443	04A3	0503	0563	05C3	
GS1-128 Enable Setting	0324	0384	03E4	0444	04A4	0504	0564	05C4	
Code93 Enable Setting	0325	0385	03E5	0445	04A5	0505	0565	05C5	
MSI/Plessey Enable Set- ting	0326	0386	03E6	0446	04A6	0506	0566	05C6	

Major Item	sub item	Table0	Table1	Table2	Table3	Table4	Table5	Table6	Table7
		Address	Address	Address	Address	Address	Address	Address	Address
		HEX	HEX	HEX	HEX	HEX	HEX	HEX	HEX
Parameter Changeover Function	Italian Pharm (Code32) Enable Setting	0327	0387	03E7	0447	04A7	0507	0567	05C7
	CIP39 Enable Setting	0328	0388	03E8	0448	04A8	0508	0568	05C8
	Tri-Optic Enable Setting	0329	0389	03E9	0449	04A9	0509	0569	05C9
	TELEPEN Enable Setting	032A	038A	03EA	044A	04AA	050A	056A	05CA
	Code11 Enable Setting	032B	038B	03EB	044B	04AB	050B	056B	05CB
	GS1 Databar Expanded Enable Setting	032C	038C	03EC	044C	04AC	050C	056C	05CC
	GS1 Databar Limited Enable Setting	032D	038D	03ED	044D	04AD	050D	056D	05CD
	GS1 Databar Omni-direc- tional Enable Setting	032E	038E	03EE	044E	04AE	050E	056E	05CE
	Reserved	032F	038F	03EF	044F	04AF	050F	056F	05CF
	Reserved	0330	0390	03F0	0450	04B0	0510	0570	05D0
	Reserved	0331	0391	03F1	0451	04B1	0511	0571	05D1
	Reserved	0332	0392	03F2	0452	04B2	0512	0572	05D2
	Reserved	0333	0393	03F3	0453	04B3	0513	0573	05D3
	Reserved	0334	0394	03F4	0454	04B4	0514	0574	05D4
	Reserved	0335	0395	03F5	0455	04B5	0515	0575	05D5
	Reserved	0336	0396	03F6	0456	04B6	0516	0576	05D6
	Reserved	0337	0397	03F7	0457	04B7	0517	0577	05D7
	Reserved	0338	0398	03F8	0458	04B8	0518	0578	05D8
	Reserved	0339	0399	03F9	0459	04B9	0519	0579	05D9
	Reserved	033A	039A	03FA	045A	04BA	051A	057A	05DA
	Reserved	033B	039B	03FB	045B	04BB	051B	057B	05DB
	DataMatrix ECC200 Enable Setting	033C	039C	03FC	045C	04BC	051C	057C	05DC
	QR Code Enable Setting	033D	039D	03FD	045D	04BD	051D	057D	05DD
	Micro QR Code Enable Setting	033E	039E	03FE	045E	04BE	051E	057E	05DE
	PDF417 Enable Setting	033F	039F	03FF	045F	04BF	051F	057F	05DF
	Micro PDF417 Enable Setting	0340	03A0	0400	0460	04C0	0520	0580	05E0
	Reserved	0341	03A1	0401	0461	04C1	0521	0581	05E1
	Reserved	0342	03A2	0402	0462	04C2	0522	0582	05E2
	Composite CC-A/B Enable Setting	0343	03A3	0403	0463	04C3	0523	0583	05E3
	Composite CC-C Enable Setting	0344	03A4	0404	0464	04C4	0524	0584	05E4
	Reserved	0345	03A5	0405	0465	04C5	0525	0585	05E5
	Reserved	0346	03A6	0406	0466	04C6	0526	0586	05E6
	GS1-Databar Stacked Omni directional Enable Setting	0347	03A7	0407	0467	04C7	0527	0587	05E7
	GS1-Databar Expanded Stacked Enable Setting	0348	03A8	0408	0468	04C8	0528	0588	05E8
Japan Postal Code Enable Setting	0349	03A9	0409	0469	04C9	0529	0589	05E9	
Reserved	034A-035F	03AA-03BF	040A-041F	046A-047F	04CA-04DF	052A-053F	058A-059F	05EA-05FF	

4.7 Communication Unit

Function Description of [the WB9Z-CU100] Communication unit.

4.7.1 Overview

The communication unit is a protocol converter that allows the WB2F to connect to Ethernet enabled devices. The WB2F can be controlled via ethernet by using the communication unit. It can also function as an RS-422 protocol converter or a relay for RS-232 communication interface.

For further details on the communication unit, refer to the manual [WB9Z-CU100]

- Connecting to an ethernet compatible device

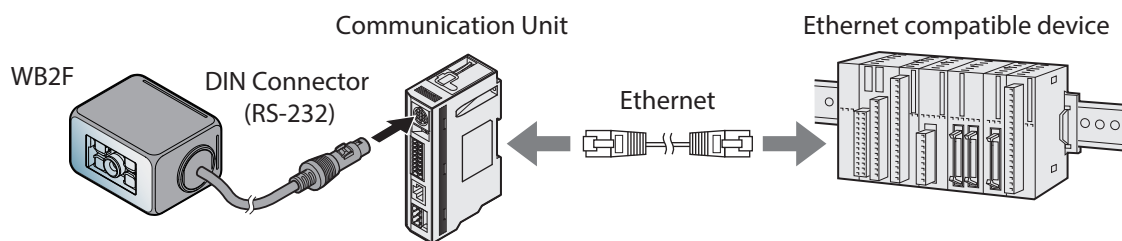

- Connecting to a RS-232 compatible device

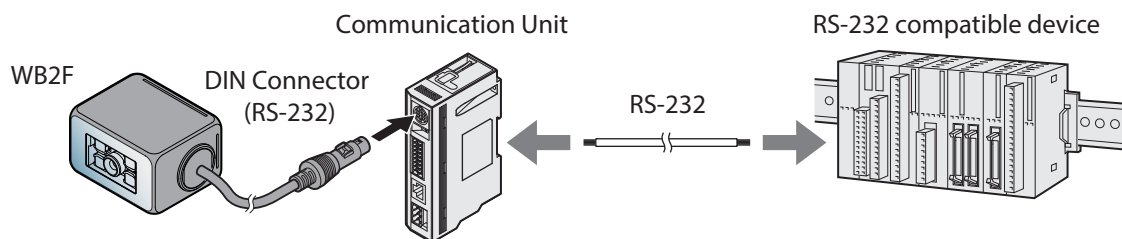

- Connecting to a RS-422 compatible device

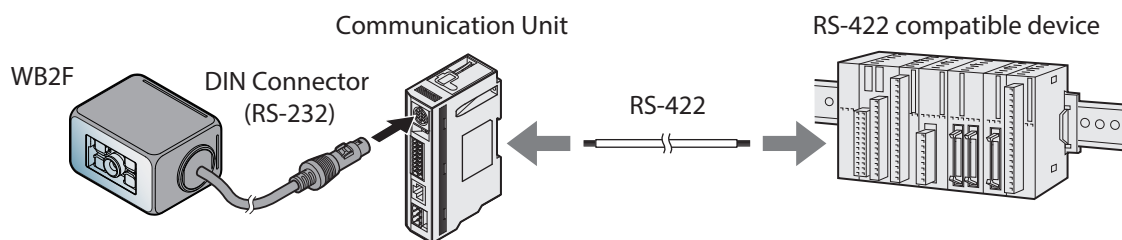

4.7.2 Names and functions of its parts

Will explain the various functions and settings of the communication unit.

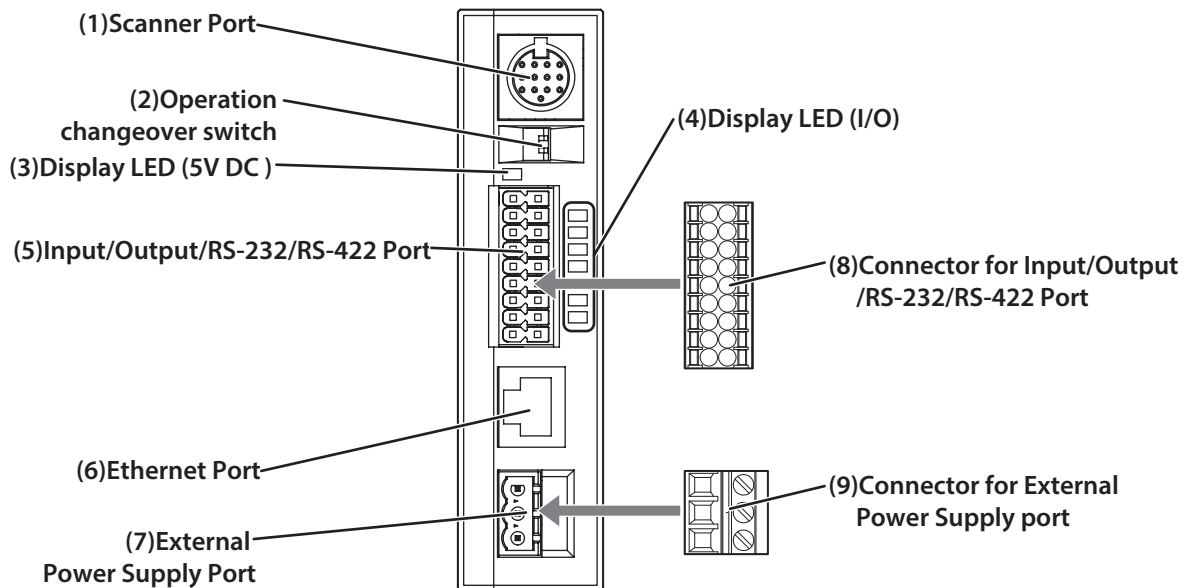

No.	Description	Function
(1)	Scanner Port	A connector of the end of scanner is DIN connector. For connection of WB2F in this manual.
(2)	Operation changeover switch	Used to changeover operation mode
(3)	Display LED (5V DC)	Lights up (green) when power is on
(4)	Display LED (I/O)	Green LED flash with External input and External output of WB2F.
(5)	Input/Output/RS-232/RS-422 Port	The communication unit is connected with "input/output /RS-232/RS-422 Port".
(6)	Ethernet Port	Will connect to a Ethernet Compatible device. PoE (Power over Ethernet) compatible
(7)	External Power Supply Port	The communication unit is connected with "External Power SUPply Port".
(8)	Connector for Input/Output/RS-232/RS-422 Port	<ul style="list-style-type: none"> Terminal plug: DFMC1.5/9-ST-3.5 (manufactured by PHOENIX CONTACT) It is used for control WB2F. It is connected with equipment of RS-232/RS-422.
(9)	Connector for External Power Supply port	External Power Port Terminal plug: FRONT-MSTB2.5/3-ST-5.08 (manufactured by PHOENIX CONTACT)



• Refer Manual(B-1946) and Users Manual(B-1963).

• For details on the dimensions of the communication unit refer to  [5. 3 Dimensional outline drawings] on page 5-7.

5 Appendix

This chapter describes WB2F specifications, troubleshooting, and contains lists of symbols.

5.1 Product specifications

Model		WB2F-100S1B
Rated power supply voltage		5V DC \pm 0.25 V ^{*2}
Consumption current		500mA or less (peak 1A or less)
Operation button		Equipped on unit (tactile switch) x 2
Reading distance	Barcode	50 to 180mm (narrow bar size 0.5mm) ^{*2}
	2D code	50 to 150mm (cell size 0.5mm) ^{*2}
Focal point		100mm
Field of view		70mm×50mm (at focalpoint)
Number of digits to be read	Barcode	64 digits max
	2D code	7,089 digits max
PCS		0.45 or higher ^{*2}
Minimum resolution		0.127mm
Light source		High brightness red LED
Imaging element		CMOS image sensor with global shutter
Frame rate	Quad-VGA (1280*960)	36fps
	720p (1280*720)	40fps
	WVGA (800*480)	60fps
Communication Interface	Serial Communication	RS-232(600 to 115,200bps) ^{*3}
	USB	USB2.0 Full-speed 12Mbps (virtual COM) ^{*4}
Connection type		13pin DIN type connector 2m
External Input		2 circuits Non-voltage contact(Low active) Voltage input(VIL : 0-1.0V, VIH : 4.0-VCC)
External Output		4 circuits NPN open collector (sink) Max. rating 26.4V DC, 50mA
Dielectric strength		500V AC (live part-dead part, 1 minute)
Anti-ESD		Contact \pm 4kV, air \pm 8kV (IEC61000-4-2)
Ambient usage temperature		0 to 45°C (no freezing)
Ambient usage humidity		30 to 85%RH (no condensation)
Ambient usage illumination		10,000lx or lower (under sunlight) 6,000lx or lower (under incandescent light) 2,000lx or lower (under fluorescent light)
Ambient usage temperature		-20 to 60°C (no freezing)
Weight		Approx. 150g
Protective construction		IP65
Certified standards		UL/c-UL Listing CE marking(self declared), VCCI(Report of Compliance), FCC(Verification), ICES-003(self declared)

Model		WB2F-100S1B
Symbol	Barcode	EAN-13/8 (including addon), UPC-A/E0/E1 (including addon), CODE39, Codabar (=NW7), Interleaved 2of5 (=ITF), Standard 2of5 (=Industrial 2of5), Matrix 2of5, Chinese Post Matrix, COOP 2of5, SCODE, Code93, Code128, GS1-128 (formerly : EAN-128), MSI/Plessey, Italian Pharmacy (Code32), CIP39, Tri-Optic, TELEPEN, Code11, GS1 Databar (formerly:RSS)(Omni-directional, Truncated, Limited, Expanded), GS1 Databar Stacked (Omni-directional,Expanded), IATA 2of5
	2D code	QR Code/ GS1 QR Code, Micro QR Code, DataMatrix (DataCode) / GS1 DataMatrix, PDF417, Micro PDF417, GS1 compos (CC-A, CC-B, CC-C), Japan Postal

*1 By IDEC standard barcode or 2D code

*2 Use only a Listed Power Supply with an output rated 5V DC and marked LPS or NEC Class 2 for use the WB2F as UL Listing product

*3 For maintenance interface (incompatible USB bus power)

*4 RS-232 setting parameters of factory setting are baud rate 9,600bps, data size 8bit, 1 stop bit, even parity bit, no flow control

5.2 Field of view/characteristics

5.2.1 Reading Range

The WB2F's reading range (representative) is as follows:

Symbol		Narrow Bar/Cell size	Reading distance
Barcode	Code39	0.127	65 to 150
		0.5	50 to 250
2D code	DataMatrix	0.127	65 to 125
		0.5	50 to 240

Unit : mm

Measurement conditions

- Using IDEC standard 1D and 2D codes
- Pitch: 0°, Skew: 15°, Tilt: 0°
- Ambient Light : 300 to 500lx

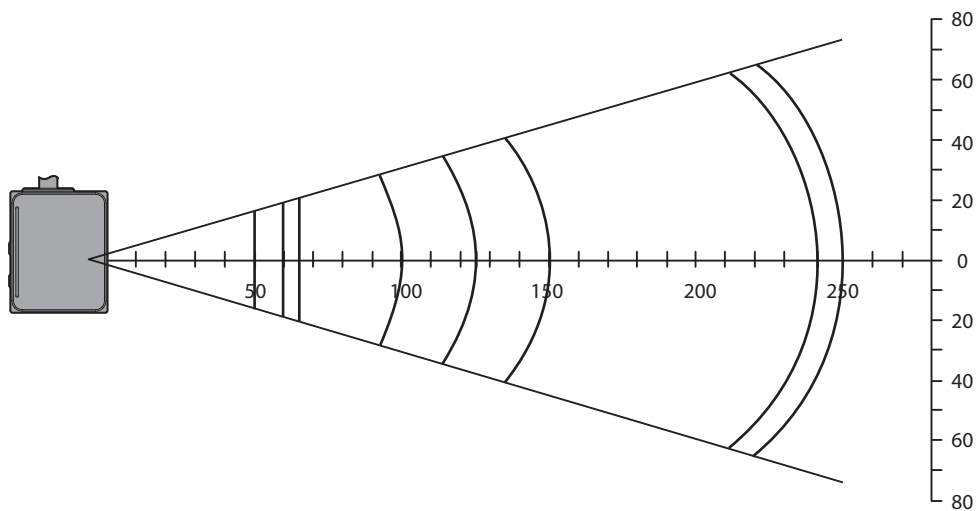

Unit : mm



- Depending on the symbol quality, the specification range may not be satisfied.
- The specification may be changed without prior notification for the purpose of product improvements.



Configure proper reading position with position assist mode.

5.2.2 Field of View

The WB2F's field of view will change as follows:

Reading distance		50	60	70	100	110	150	180
Field of view	Horizontal	36	43	49	70	76	103	123
	Perpendicular	26	30	35	50	54	73	88

Unit : mm

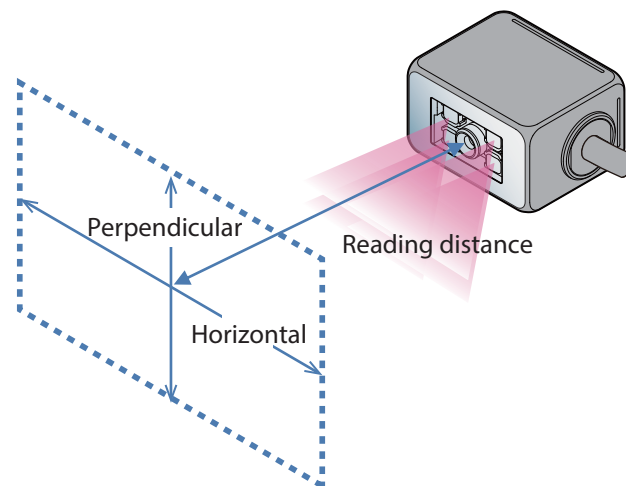

The specification may be changed without prior notification for the purpose of product improvements.

5.2.3 Angle Characteristics

Lighting LED Number of lights	Pitch	Skew	Tilt
4	$-60^\circ \leq \theta \leq +60^\circ$	$-60^\circ \leq \theta \leq -15^\circ, +15^\circ \leq \theta \leq +60^\circ$	$\pm 180^\circ$
Top 2		$-60^\circ \leq \theta \leq -15^\circ, +13^\circ \leq \theta \leq +60^\circ$	
Bottom 2		$-60^\circ \leq \theta \leq -13^\circ, +15^\circ \leq \theta \leq +60^\circ$	

Measurement conditions

Reading distance :
100 mm
Using IDEC standard
symbol

■ Pitch

The shaped of the left and right of $-60^\circ \leq \theta \leq +60^\circ$ (Skew of $+15^\circ$ deg).

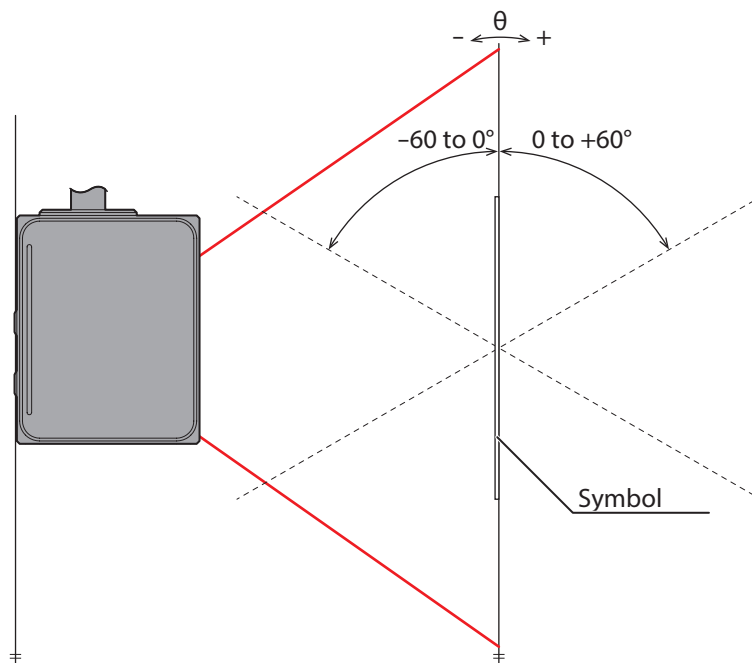

■ Skew

The shaped of the front and back of $-60^\circ \leq \theta \leq -15^\circ$ and $+15^\circ \leq \theta \leq +60^\circ$ (4 Emitter LEDs, Pitch is 0 deg.)

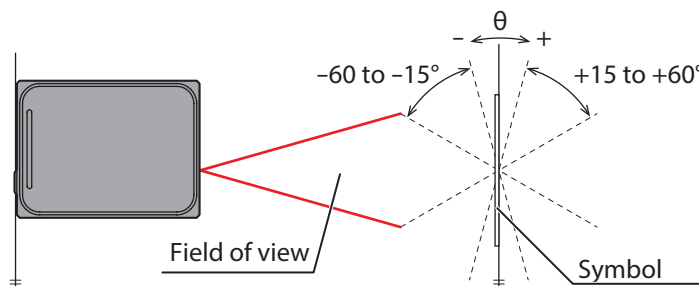

Do not use the area of Skew $-15^\circ < \theta < +15^\circ$ (dead zone) , when four of illumination LED are flashed.
It will be decreasing reading performance such as misreading and no reading.

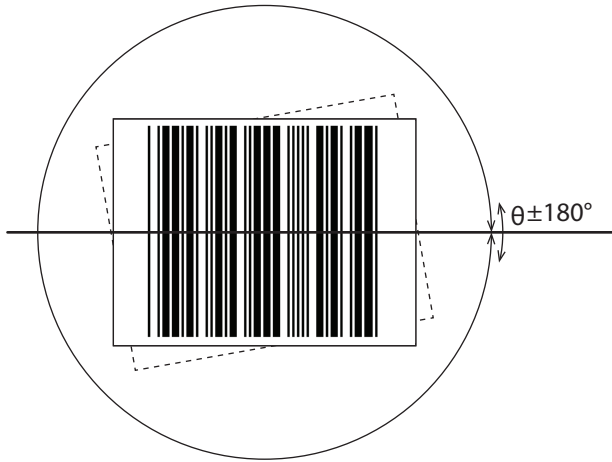
■ TiltRotation angle $\pm 180^\circ$ 

5.3 Dimensional outline drawings

•The WB2F

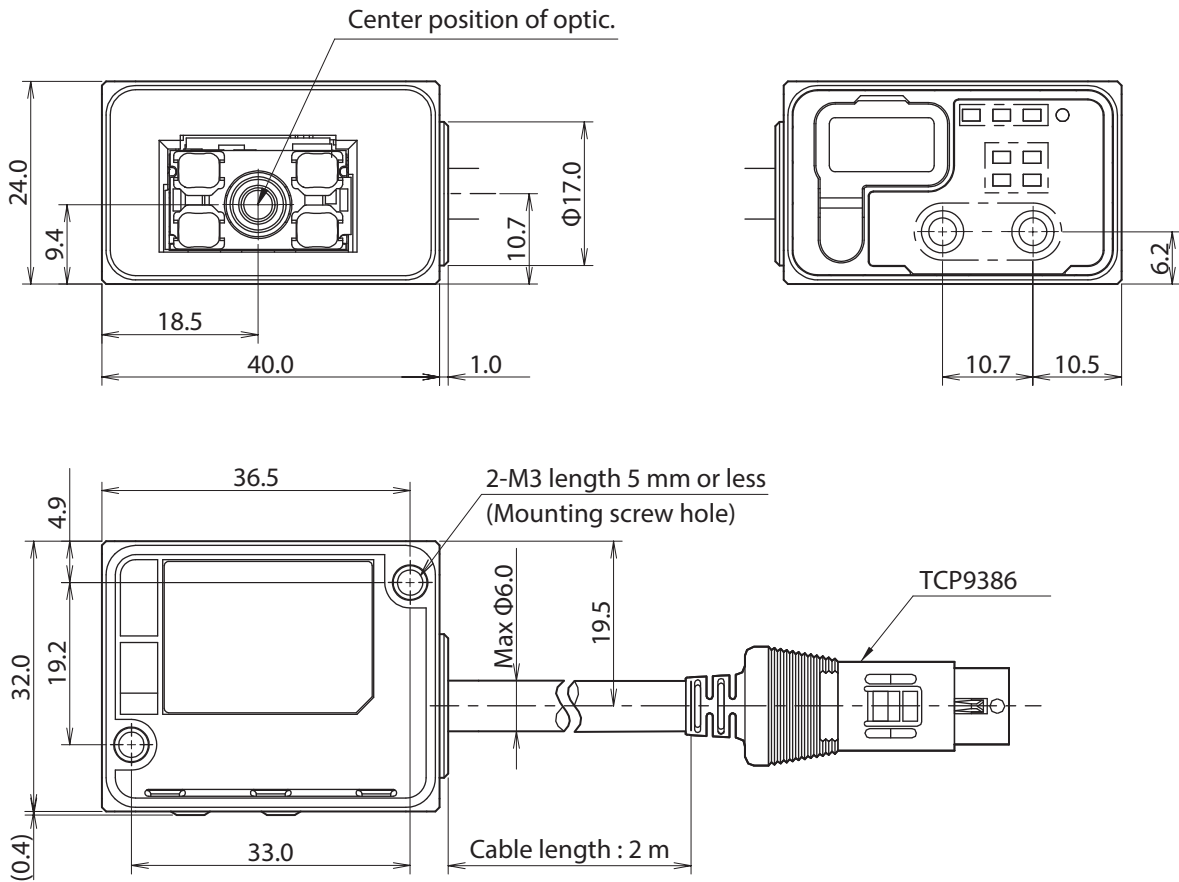

Unit : mm

•Mounting Bracket

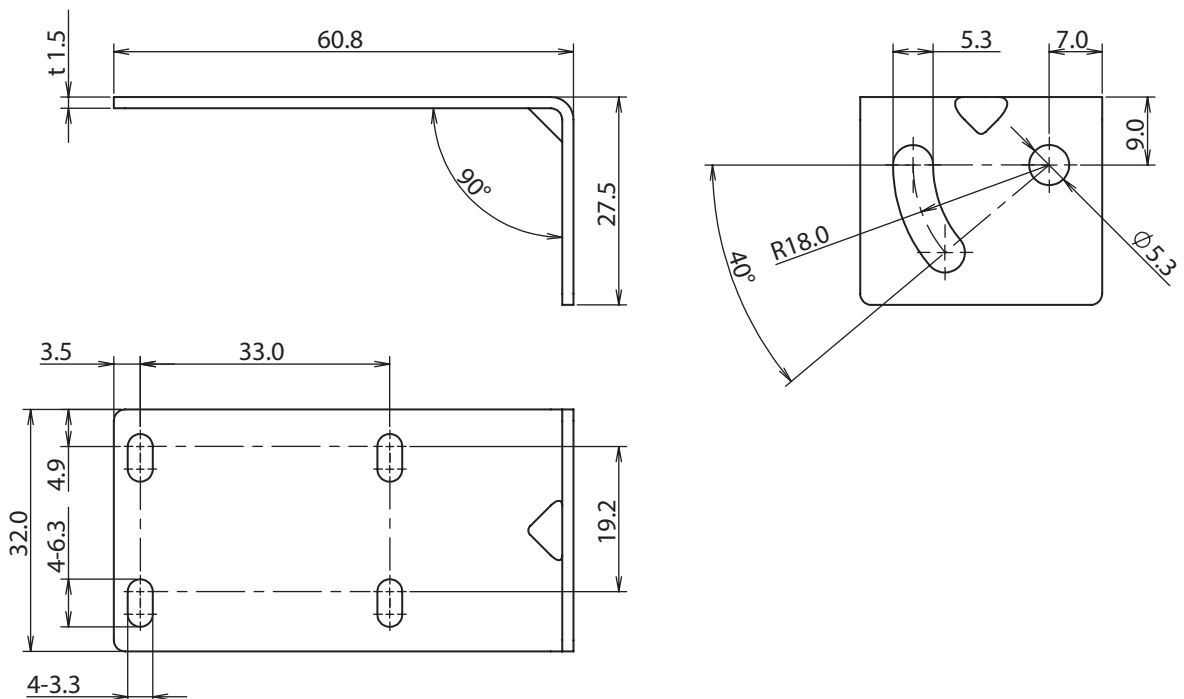

Unit : mm

• Communication Unit (WB9Z-CU100)

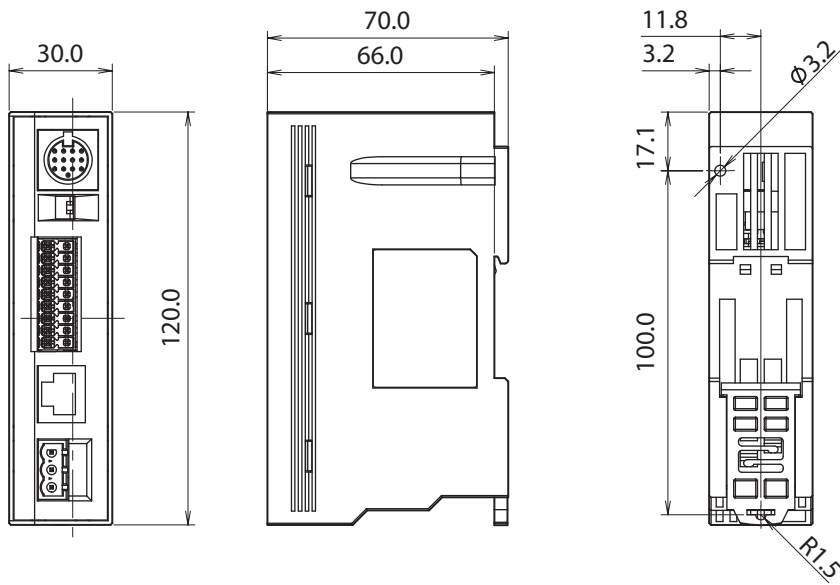

Unit : mm

5.4 Troubleshooting

When using the WB2F, if an operation occurs that you think is a problem, read the following problems and items to check to resolve the problem.

If you cannot resolve the problem, contact your local dealer or customer service.

Problem	Items to check
Emitter LED does not turn on	<ul style="list-style-type: none"> • Are the positive and negative wires for the 5 V power supply correctly connected? • Are the settings for the Lighting LED correct?
Cannot read symbols	<ul style="list-style-type: none"> • Are the symbols dirty? • Are there any problems with the print quality of the symbols? • Is the WB2F reading window dirty? • Has the film been left on the reading window? • Is there are a problem with the WB2F installation position? • Is there are a problem with the WB2F settings?
RS-232 communication is not possible	<ul style="list-style-type: none"> • Are the RS-232 communication settings correct? • Are the communication settings between the host device and the WB2F the same? • Is the wiring correct?
USB communication is not possible	<ul style="list-style-type: none"> • Have you installed the device driver? • Is the WB2F recognizing the PC? • Have you correctly selected the port number connected to the WB2F?
Status LEDs, Position LEDs not lighting up	<ul style="list-style-type: none"> • Are the settings for the Status LED and the position LED correct?
External Input is not working	<ul style="list-style-type: none"> • Are the settings for external input (IN0,1) correct? • Is the wiring correct?
External Output is not working	<ul style="list-style-type: none"> • Are the settings for external output (Out0-3) correct? • Is the wiring correct?
The reading request does not turn on with the READ/ENTER button	<ul style="list-style-type: none"> • Are the READ/ENTER button settings correct?
The Reading Request does not turn OFF using the SELECT button	<ul style="list-style-type: none"> • Are the settings for the SELECT button correct?

5.5 Timing Chart

Will explain the WB2F read operation and external output timing charts.

5.5.1 Scan Operation Timing Chart

Indicates the WB2F read operation timing chart.

e.g. If reading a symbol given the following conditions

Item	Details
Read Mode	Single Read (Edge Activation)
Read Request	External Input
Parameter Table Settings	"FFH"(Auto)
Sequence Table Count	"03H" ([0]=2, [1]=1, [2]=5)

The WB2F read operation timing chart is as follows:

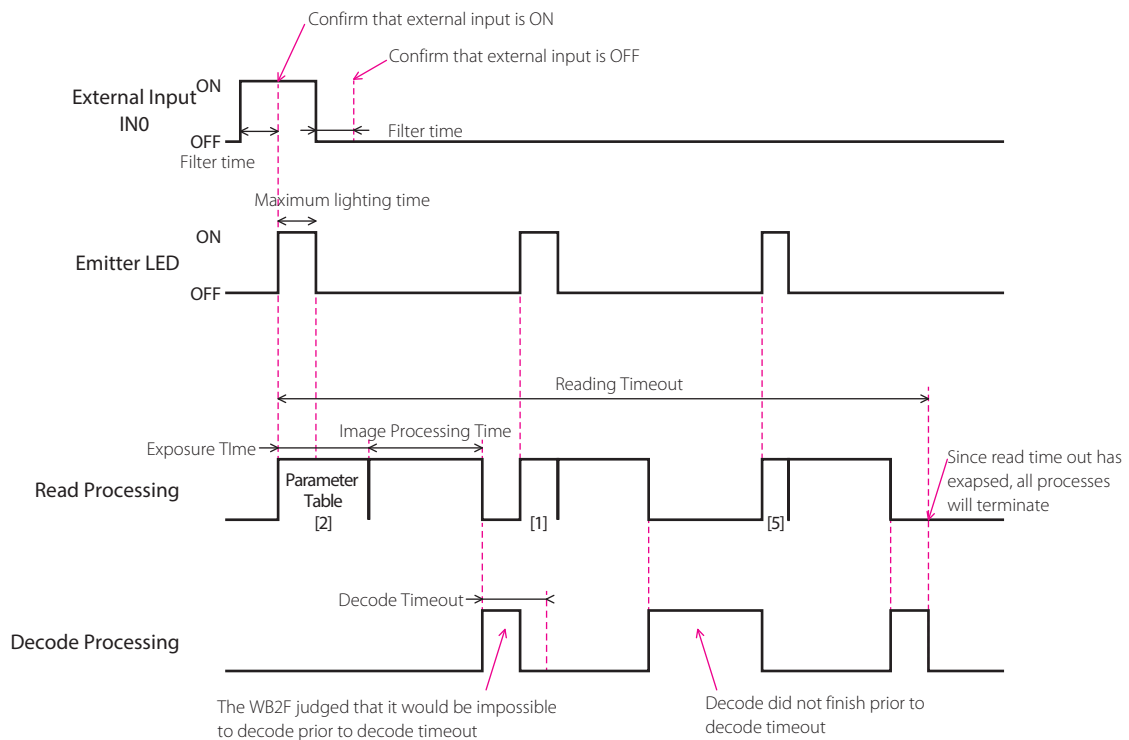

Maximum flashing time of emitter LED is affected by frame arte and Flashing mode.
Each light's maximum lighting time is as follows.

Resolution	Image quality	Frame rate	Lighting ON Mode	
			Normal usage	Boost
QuadVGA	High	36fps	5ms	1.4ms
	Low	60fps		0.8ms
720P	High	40fps		1.0ms
	Low	60fps		0.8ms
WVGA	High	60fps		0.8ms
	Low	60fps		0.8ms



- If read time out elapses, all processes will cease
- Make sure you choose a decode timeout value that is less than the Reading timeout value



- Filter time can be set at any value between 1 to 100ms
- It is configurable of range 100 to 25,500 ms and Infinite.
- Decode Timeout can be set at either Infinite or any value between 100 to 25,500ms
- Exposure time can be set at any value between 0.09 to 10.00ms
- Maximum image processing time is 27.80ms

5.5.2 External Output Timing Chart

● OK/NG Output

OK Output turns ON when Reading Success or Verification Success occurs

NG Output turns ON when Read Failure or Verification Failure occurs

Operating logic of output can be chosen from "positive logic" and "negative logic".

The timing chart when set to [positive logic] is as follows:

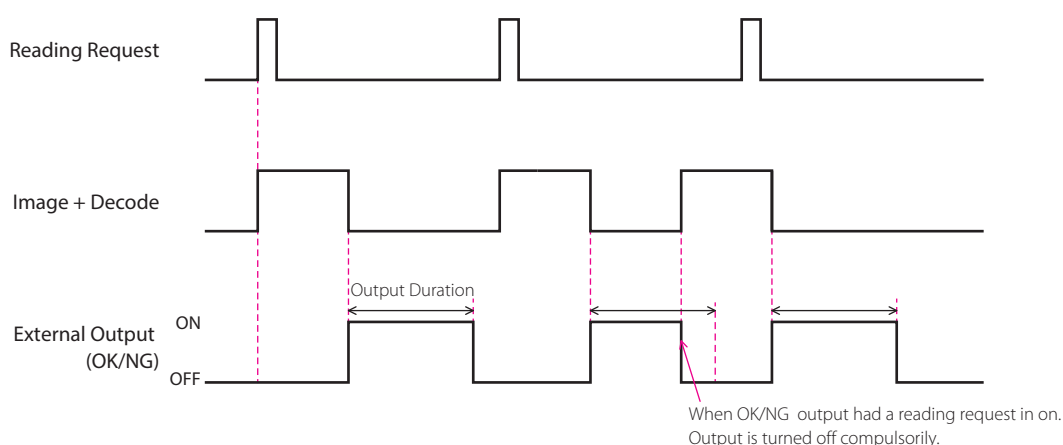

- Output enable time can be set as infinite, or any value between 10 to 2,550 ms.
- While OK Output or NG Output was on, when a reading request became on the outside output is turned off compulsorily.

● BUSY Output

The BUSY output will keep output ON until a reading operation is completed.

Operating logic of output can be chosen from "positive logic" and "negative logic".
The timing chart when set to [positive logic] is as follows:

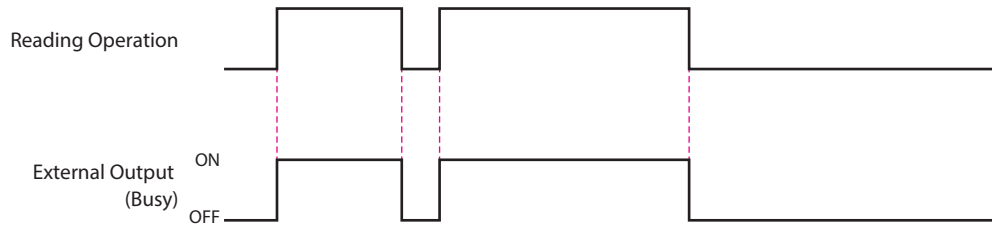

Reading operation includes a reading request, image acquisition + decoding



You cannot specify a valid time for an output

● FLASH synchronous output

Flash synchronous output turns on synchronously in time with exposure time.

Output polarity can be set as either [Positive logic] or [negative logic].
The timing chart when set to [positive logic] is as follows:

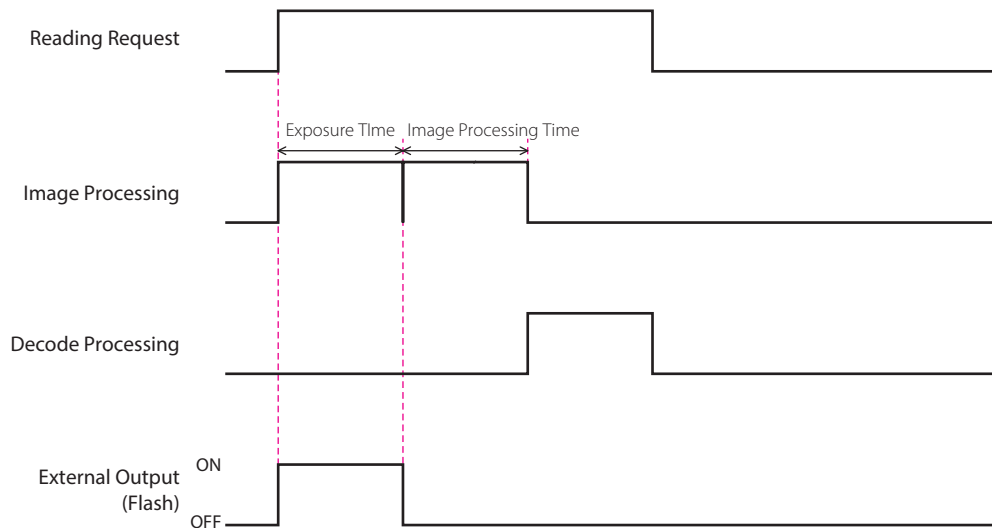

- Exposure time can be set at any value between 0.09 to 10.00ms
- Maximum image processing time is 27.80ms

5.6 List of Control Commands

No.	Name	Control command			Description
		Prefix	Mnemonic	Suffix	
1	Start Reading	^	get	CR LF	Start symbol read
2	Start Reading (Read Parameter Table Specification)	^	get xx	CR LF	The Symbol Reading using the reading parameter table is started. xx can choose 00-07. Refer to [5.7 Control Commands (Details)] on page 5-17.
3	Start Designated Area Reading	^	rget Sx Sy Ex Ey	CR LF	The designated area reading is started. Sx,Sy,Ex,Ey inputs coordinate data. Refer to [5.7 Control Commands (Details)] on page 5-17.
4	Start Designated Area Reading (read parameter table specification)	^	rget xx Sx Sy Ex Ey	CR LF	The designated area reading using the reading parameter table is started. Sx,Sy,Ex,Ey inputs coordinate data. Refer to [5.7 Control Commands (Details)] on page 5-17.
5	Stop Reading	^	stop	CR LF	Stops symbol reading
6	Snap Shot	^	sshot	CR LF	Only captured imaging is performed. The captured imaging is stored in the imaging memory.
7	Snap Shot (Reading parameter table specification)	^	sshot xx	CR LF	Only captured imaging in a reading parameter table is performed. xx can choose 00-07. The captured imaging is stored in the imaging memory. Refer to [5.7 Control Commands (Details)] on page 5-17.
8	Image Memory Bitmap Image Acquisition	^	iget	CR LF	The image data stored in the Bitmap imaging memory is acquired. Refer to [5.7 Control Commands (Details)] on page 5-17.
9	Image Memory JPEG Image Acquisition	^	icget	CR LF	The image data stored in the JPEG imaging memory is acquired. Refer to [5.7 Control Commands (Details)] on page 5-17.
10	Verification Start	^	cmp**	CR LF	Symbol Reading undergo verification. The Verification results are output. Sequentially input master data can be added to the output data. For further details, refer to [5.7 Control Commands (Details)] on page 5-17.
11	External Output 0 OFF	^	outputa0	CR LF	Sets External Output 0 to the OFF State
12	External Output 0 ON	^	outputa1	CR LF	Sets External Output 0 to the ON State
13	External Output 1 OFF	^	outputb0	CR LF	Sets External Output 1 to the OFF State
14	External Output 1 ON	^	outputb1	CR LF	Sets External Output 1 to the ON State
15	External Output 2 OFF	^	outputc0	CR LF	Sets External Output 2 to the OFF State
16	External Output 2 ON	^	outputc1	CR LF	Sets External Output 2 to the ON State
17	Status LED (Red) OFF	^	leda0	CR LF	Sets the Status LED (Red) to the OFF State
18	Status LED (Red) ON	^	leda1	CR LF	Sets the Status LED (Red) to the ON State

No.	Name	Control command			Description
		Prefix	Mnemonic	Suffix	
19	Status LED (Orange) OFF	^	ledb0	CR LF	Sets the Status LED (orange) to the OFF State
20	Status LED (Orange) ON	^	ledb1	CR LF	Sets the Status LED (Orange) to the ON State
21	Status LED (Green) OFF	^	ledc0	CR LF	Sets the Status LED (Green) to the OFF State
22	Status LED (Green) ON	^	ledc1	CR LF	Sets the Status LED (Green) to the ON State
23	Initialize temporary image memory	^	fs_fmta	CR LF	Initializes temporary image memory. During initialization, the Status LED (orange) will blink. Time to complete initialization is within 5s.
24	Initialize non-volatile image memory	^	fs_fmtd	CR LF	Initializes non-volatile image memory. During initialization, the Status LED (orange) will blink. Time to complete initialization is within 30s
25	Retrieve free temporary image memory file count	^	fs_blka	CR LF	To get remaining of number of to acquire temporary image in memory. It is not possible to store temporary image in memory when a reply of the number of remaining files will be 0000. Execute to initialize temporary image memory when you would like to get new temporary image. Refer to [5. 7 Control Commands (Details)] on page 5-17.
26	Retrieve non-volatile image memory file count	^	fs_blkdb	CR LF	To get remaining of number of to acquire non-volatile image in memory. It is not possible to store non-volatile image in memory when a reply of the number of remaining files will be 0000. Execute to initialize non-volatile image memory when you would like to get new non-volatile image. Refer to [5. 7 Control Commands (Details)] on page 5-17.
27	Acquire temporary Image memory file data	^	fs_geta yyyy	CR LF	Data of a specified number file in the temporary picture memory is acquired. yyyy can choose 0000 to 0015. Refer to [5. 7 Control Commands (Details)] on page 5-17.
28	Acquire non-volatile image memory file data	^	fs_getb yyyy	CR LF	Data of a specified number file in the non-volatile picture memory is acquired. yyyy can choose 0000 to 0015. Please refer to [5. 7 Control Commands (Details)] on page 5-17.
29	Reading success rate measurement starting	^	sup0	CR LF	Switches to setup support mode and starts the setup support function reading success rate measurement.
30	Reading success rate measurement starting (Reading parameter table selected)	^	sup0 xx	CR LF	It is changed to position assist mode and reading success rate measurement in a reading parameter table is started. xx can choose 00 to 07. Refer to [5. 7 Control Commands (Details)] on page 5-17.
31	Start Decoding Processing Time Measurement	^	sup1	CR LF	It is changed to position assist mode and Decoding Processing Time measurement is started.
32	Start Decoding Processing Time measurement (read parameter table specification)	^	sup1 xx	CR LF	It is changed to position assist mode and Decoding Processing Time measurement in a reading parameter table is started. xx can choose 00-07. Refer to [5. 7 Control Commands (Details)] on page 5-17.

No.	Name	Control command			Description
		Prefix	Mnemonic	Suffix	
33	Start symbol position measurement	^	sup2	CR LF	It is changed to position assist mode and symbol position measurement is started.
34	Start symbol position measurement (Reading parameter table specification)	^	sup2 xx	CR LF	It is changed to position assist mode and symbol position measurement in a reading parameter table is started. xx can choose 00 to 07. Refer to [5.7 Control Commands (Details)] on page 5-17.
35	Switch to Setup support mode (standard adjusting)	^	tune0	CR LF	Specialized adjusting is performed for symbol printed on paper which the reading as easy.
36	Switch to Setup support mode (specialized adjusting)	^	tune1	CR LF	Specialized adjusting is performed for symbol(DPM, etc) printed which the reading as difficult.
37	Status transition of Setup support mode (custom adjusting)	^	tune2	CR LF	This function is adjusting value of the auto configuration after confured value of the auto configuration.
38	Switch to slave mode	^	slave	CR LF	Switches to slave mode.
39	Switch to maintenance mode	^	mainte	CR LF	Switches to maintenance mode.
40	Reset (after 10 seconds)	^	reset10	CR LF	Executes a reset after 10 seconds.
41	Reset (after 5 seconds)	^	reset5	CR LF	Executes a reset after 5 seconds.
42	Reset (after 1 second)	^	reset	CR LF	Executes a reset after 1 second.
43	Load setting values	^	load	CR LF	Loads the setting values from the currently selected setting value region (non-volatile memory).
44	Save setting values	^	save	CR LF	Saves the setting values to the currently selected setting value region (non-volatile memory). While saving, the Status LED (orange) will blink. Saving will complete within 5s.
45	Initialize setting values	^	iNiTiAl	CR LF	Resets all setting values to the factory defaults. During initialization, the Status LED (orange) will blink. Time to complete initialization is within 30s.
46	Get version	^	ver	CR LF	Gets the version of the firmware. Example: Response when getting the version ^WB2F-100S1B/A-001.000.00/B-001.000.00 CR LF For details, refer to [5.7 Control Commands (Details)] on page 5-17.
47	Get communication settings (Current value)	^	comgetc	CR LF	Gets the RS-232 interface communication settings. (Current value) Example: Response when getting the current values of the communication settings ^07,01,01,00,00/00,00,00,00/5e,00,00,00/0d,0a,00,00 CR LF (^baud rate, data length, parity, stop bits, flow control/reserved, add check digit, uppercase response, reserved/4 prefixes/4 suffixes) CR LF For details, refer to [5.7 Control Commands (Details)] on page 5-17.

No.	Name	Control command			Description
		Prefix	Mnemonic	Suffix	
48	Get communication settings (Memory value)	^	comgetm	CR LF	<p>Gets the RS-232 interface communication settings. (The setting values applied at startup)</p> <p>e.g. Response when getting the communication settings applied at startup</p> <p>^07,01,01,00,00/00,00,00,00/5e,00,00,00/0d,0a,00,00 CR LF</p> <p>(^baud rate, data length, parity, stop bits, flow control/reserved, add check digit, uppercase response, reserved/4 prefixes/4 suffixes CR LF)</p> <p>For details, refer to [5.7 Control Commands (Details)] on page 5-17.</p>



The prefix and suffix listed in the control commands list are the factory default settings.

5.7 Control Commands (Details)

•No. 2 Start Reading (Specify Reading Parameter Table)

Transmission Example

Prefix	Command	Space (half size)	Specified Table Number	Suffix
^	get	┌	00	CR LF

A value between "00" to "07" will be entered as the Specified table number

•No.3 Start Reading Designated Area

Transmission Example

Prefix	Command	Space (half size)	Start Coordinate X Axis	Space (half size)	Start Coordinate Y Axis	Space (half size)
^	rget	┌	0000	┌	0000	┌

End Coordinate X Axis	Space (half size)	End Coordinate Y Axis	Suffix
1279	┌	0959	CR LF

Start Coordinate X Axis, End Coordinate X Axis will have a value between "0000" to "1279".

Start Coordinate Y Axis, End Coordinate Y Axis will have a value between "0000" to "0959".

Do not select a starting coordinate value that is larger than the ending coordinate.

•No 4 Start Reading Designated Area (Reading parameter table specification)

Transmission Example

Prefix	Command	Space (half size)	Specified Table Number	Space (half size)	Start Coordinate X Axis	Space (half size)
^	rget	┌	00	┌	0000	┌

Start Coordinate Y Axis	Space	End Coordinate X Axis	Space (half size)	End Coordinate Y Axis	Suffix
0000	┌	1279	┌	0959	CR LF

A value between "00" to "07" will be entered as the Specified table number.

Start Coordinate X Axis, End Coordinate X Axis will have a value between "0000" to "1279".

Start Coordinate Y Axis, End Coordinate Y Axis will have a value between "0000" to "0959".

Do not select a starting coordinate value that is larger than the ending coordinate.

•No. 7 Start Snapshot (Reading Parameter Table specification)

Transmission Example

Prefix	Command	Space (half size)	Specified Table Number	Suffix
^	sshot	┌	00	CR LF

A value between "00" to "07" will be entered as the Specified table number.

•No 8. Image memory Acquire Bitmap Image

Transmission Example

It reply continuously by the following form every 16 bytes of image data.

Image Data 16 bytes															Suffix		
00	01	02	03	04	05	06	07	08	09	0A	0B	0C	0D	0E	0F	CR	LF

Transmit an image data even if the image Data is less than 16 bytes.

Below is an example of a 10byte transmission

Image Data 16 bytes										Suffix	
00	01	02	03	04	05	06	07	08	09	CR	LF

Response example

424D36C4120000000000360400002800	CR	LF
00000005000040FCFFFF010008000000	CR	LF
000000C0120000000000000000000000	CR	LF
00000000000000000000000010101000202	CR	LF
02000303030004040400050505000606	CR	LF
:		
:abridged		
0E0E0E0D0D0E0D0D0E0E0D0E0D0E0D0D	CR	LF
0D0D0D0E0D0D0D0D0D0E0D0D0E0D0E0E	CR	LF
0D0E0E0D0D0E0E0E0E0D0E0E0E0E0E0D	CR	LF
E0E0E0D0C0D1D4EC1A183	CR	LF



- There is no prefix
- Suffix is fixed

•No 9 Image Memory Acquire JPEG Image

Response example

No. 8 Image Memory Bitmap Response will be given in the same format as image acquisition.

•No. 10 Start Verification

Transmission Example

Prefix	Command	Master data	Suffix
^	cmp	12345	CR LF

Compared data enters in master data.

- No. 25 Retrieve free Temporary Image Memory file count

Response example

Prefix	Number of Files	Suffix
^	0000	CR LF

A value between "0000" to "0016" will be entered in File Count.

- No. 26 Retrieve free non-volatile image memory file count

Response example

Prefix	Number of Files	Suffix
^	0000	CR LF

A value between "0000" to "0128" will be entered in File Count.

- No. 27. Acquire temporary image memory file data

Transmission Example

Prefix	Command	Space (half size)	File No.	Suffix
^	fs_geta	_	0000	CR LF

A value between "0000" to "0015" will be entered in File Number

Response example

No. 8 Image Memory Bitmap Response will be given in the same format as image acquisition.

- No. 28 Acquire non-volatile image memory file data

Transmission Example

Prefix	Command	Space (half size)	File No.	Suffix
^	fs_getb	_	0000	CR LF

A value between "0000" to "0127" will be entered in File Number.

Response example

No. 8 Image Memory Bitmap Response will be given in the same format as image acquisition.

- No. 30 Start Reading Success Rate Measurement (Reading Parameter Table Specification)

Transmission Example

Prefix	Command	Space (half size)	Specified Table Number	Suffix
^	sup0	_	00	CR LF

A value between "00" to "07" will be entered as the Specified table number.

- No.32 Start Decoding Processing Time measurement (Reading Parameter table specification)

Transmission Example

Prefix	Command	Space (half size)	Specified Table Number	Suffix
^	sup1	␣	00	CR LF

A value between "00" to "07" will be entered as the Specified table number.

- No. 34 Start Symbol Position Measurement (Reading Parameter Table Specification)

Transmission Example

Prefix	Command	Space (half size)	Specified Table Number	Suffix
^	sup2	␣	00	CR LF

A value between "00" to "07" will be entered as the Specified table number.

- No. 46 Acquire Version Information

Response example

Prefix	Model number	Separator	Main application version	Separator	Bootloader version	Suffix
^	WB2F-100S1B	/	A-001.000.00	/	B-001.000.00	CR LF

WB2F-100S1B will be entered for model number.

The main application version is the numeric values in the format 3-digit. 3-digit. 2-digit that follow A- which indicates the main application.

The bootloader version is the numeric values in the format 3-digit. 3-digit. 2-digit that follow B- which indicates the bootloader.

- No.47 Get communication settings (current values), No. 48 Get communication settings (memory values)

Response example

Prefix	RS-232 settings					Separator
	Communication speed	Data Length	Parity	Stop bits	Flow control	
^	03,	01,	01,	00,	00	/

Communication command Function				Separator
Reserved	Check digit addition	Uppercase response	Reserved	
00,	00,	00,	00	/

Communication command Function				Separator
Prefix	Prefix	Prefix	Prefix	
5e,	00,	00,	00	/

Communication command Function				Suffix
Suffix	Suffix	Suffix	Suffix	
0d,	0a,	00,	00	CR LF

The RS-232 settings are the setting values in "RS-232 settings" in [\[4. 6 Configuration Item Table\]](#) on page 4-54.

The communication command is the setting values in "Communication Command" in [\[4. 6 Configuration Item Table\]](#) on page 4-54.

5.8 Check digit calculation method

A check digit can be added to the output data for readout data and configuration commands. The check digit is expressed as an 2 digit hexadecimal ASCII code in text.

Calculation range and position where added

The calculation range of the check digit and the position where it is added are as follows.

- For output data

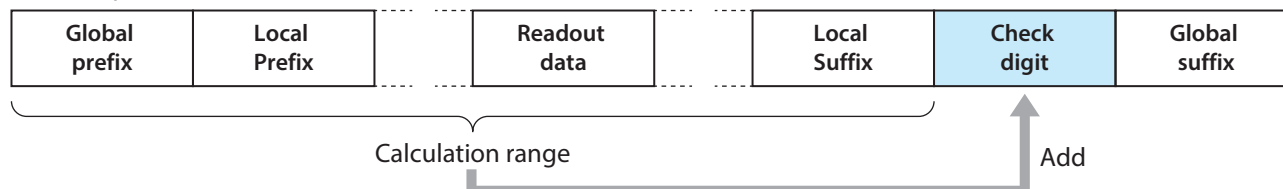

- For configuration commands



Calculation method

All of the ASCII code values for the calculation range are added up, that value is inverted, and 1 is added to it.

e.g. \wedge s1234x118b CR LF

$$5eH + 73H + 31H + 32H + 33H + 34H + 78H + 31H + 31H = 275H$$

$$275H \text{ NOT} = d8aH$$

$$d8aH + 1 = d8bH$$

$$d8bH \& 0ffH = 08bH$$

$$\text{Check Digit} = 8bH$$

5.9 ASCII Code Table

Character	Decimal	Hexadecimal	Binary
NUL	0	00	00000000
SOH	1	01	00000001
STX	2	02	00000010
ETX	3	03	00000011
EOT	4	04	00000100
ENQ	5	05	00000101
ACK	6	06	00000110
BEL	7	07	00000111
BS	8	08	00001000
HT	9	09	00001001
LF / NL	10	0A	00001010
VT	11	0B	00001011
FF / NP	12	0C	00001100
CR	13	0D	00001101
SO	14	0E	00001110
SI	15	0F	00001111
DLE	16	10	00010000
DC1	17	11	00010001
DC2	18	12	00010010
DC3	19	13	00010011
DC4	20	14	00010100
NAK	21	15	00010101
SYN	22	16	00010110
ETB	23	17	00010111
CAN	24	18	00011000
EM	25	19	00011001
SUB	26	1A	00011010

Character	Decimal	Hexadecimal	Binary
ESC	27	1B	00011011
FS	28	1C	00011100
GS	29	1D	00011101
RS	30	1E	00011110
US	31	1F	00011111
(SP)	32	20	00100000
!	33	21	00100001
"	34	22	00100010
#	35	23	00100011
\$	36	24	00100100
%	37	25	00100101
&	38	26	00100110
'	39	27	00100111
(40	28	00101000
)	41	29	00101001
*	42	2A	00101010
+	43	2B	00101011
,	44	2C	00101100
-	45	2D	00101101
.	46	2E	00101110
/	47	2F	00101111
0	48	30	00110000
1	49	31	00110001
2	50	32	00110010
3	51	33	00110011
4	52	34	00110100
5	53	35	00110101
6	54	36	00110110
7	55	37	00110111
8	56	38	00111000
9	57	39	00111001
:	58	3A	00111010
;	59	3B	00111011
<	60	3C	00111100

Character	Decimal	Hexadecimal	Binary
=	61	3D	00111101
>	62	3E	00111110
?	63	3F	00111111
@	64	40	01000000
A	65	41	01000001
B	66	42	01000010
C	67	43	01000011
D	68	44	01000100
E	69	45	01000101
F	70	46	01000110
G	71	47	01000111
H	72	48	01001000
I	73	49	01001001
J	74	4A	01001010
K	75	4B	01001011
L	76	4C	01001100
M	77	4D	01001101
N	78	4E	01001110
O	79	4F	01001111
P	80	50	01010000
Q	81	51	01010001
R	82	52	01010010
S	83	53	01010011
T	84	54	01010100
U	85	55	01010101
V	86	56	01010110
W	87	57	01010111
X	88	58	01011000
Y	89	59	01011001
Z	90	5A	01011010
[91	5B	01011011
\	92	5C	01011100
]	93	5D	01011101
^	94	5E	01011110
_	95	5F	01011111
`	96	60	01100000
a	97	61	01100001
b	98	62	01100010
c	99	63	01100011
d	100	64	01100100

Character	Decimal	Hexadecimal	Binary
e	101	65	01100101
f	102	66	01100110
g	103	67	01100111
h	104	68	01101000
i	105	69	01101001
j	106	6A	01101010
k	107	6B	01101011
l	108	6C	01101100
m	109	6D	01101101
n	110	6E	01101110
o	111	6F	01101111
p	112	70	01110000
q	113	71	01110001
r	114	72	01110010
s	115	73	01110011
t	116	74	01110100
u	117	75	01110101
v	118	76	01110110
w	119	77	01110111
x	120	78	01111000
y	121	79	01111001
z	122	7A	01111010
{	123	7B	01111011
	124	7C	01111100
}	125	7D	01111101
~	126	7E	01111110
DEL	127	7F	01111111

 indicates a control character.

(SP) indicates a space character.

The other characters indicate graphic characters.

5.10 AIM symbology ID table

The AIM-compliant symbology identification IDs are as follows.

The output name is:

] + ID + modifier

A total of 3 digits.

However, for the AIM ID modifier, undefined items are output as "x".

Symbology name	AIM ID	
	ID	Modifier
Code39	A	0: No check character validation. No full ASCII processing. All data is transmitted as decoded. 1: Check character is validated and transmitted. 3: Check character is validated but not transmitted. 4: Full ASCII character conversion is executed. No check character validation. 5: Full ASCII character conversion is executed. Modulo 43 check character is validated and transmitted. 7: Full ASCII character conversion is executed. Modulo 43 check character is validated but not transmitted.
Codabar	F	0: Standard symbols, no special processing. 2: Check character validated. 4: Check character validated, but not transmitted
Interleaved 2of5	I	0: No check character validation. 1: Check character is validated and transmitted. 3: Check character is validated but not transmitted.
Standard 2of5	S	0: No option
Matrix 2of5	X	9
IATA 2of5	R	0: No check character validation 1: Check character is validated and transmitted. 3: Check character is validated but not transmitted.
Coop-2of5	X	9
Scode	X	9
Chinese-Post	X	9
UPC-A	E	0: Standard format (no add-on) 3: Add 2-digit or 5-digit add-on to EAN-13, UPC-A, or UPC-E0/E1 4: EAN-8 data
UPC-E0		
UPC-E1		
EAN-13		
EAN-8		
Code128/GS1-128	C	0: Standard format 1: GS-128
Code93	G	0
MSI/Plessey	M	0: Check character is validated and transmitted. 1: Check character is validated but not transmitted. X: Other than above (no check, 2-digit check, no 2 digits transmission, etc.)
Italian Pharmacy (Code32)	X	9
CIP39	X	9
Tri-Optic	X	9

Symbology name	AIM ID	
	ID	Modifier
TELEPEN	B	0: Full ASCII mode 1: Number limited mode
Code11	H	0: Check character 1 digit is validated and transmitted. 1: Check character 2 digits is validated and transmitted 3: Check character is validated but not transmitted. X: Check character is not validated.
GS1 Databar	e	0
Data Matrix	d	1: ECC 200 2: ECC 200, FNC1 in first or fifth position 3: ECC 200, FNC1 in second or sixth position
QR Code/ Micro QR Code	Q	0: QR Code Model 1 symbol (in accordance with AIM ISS 97-001) 1: QR Code 2005 symbol, ECI protocol not implemented 3: QR Code 2005 symbol, ECI protocol not implemented, FNC1 implied in first position 5: QR Code 2005 symbol, ECI protocol not implemented, FNC1 implied in second position
PDF 417/ Micro PDF417/ GS1 composite	L	1: Reader set to follow protocol of ISO/IEC 15438 for Extended Channel Interpretation (All data characters 92 doubled) 3: Code 128 emulation: implied FNC1 in first position 4: Code 128 emulation: implied FNC1 after initial letter or pair of digits 5: Code 128 emulation: no implied FNC1 Modifier values 3, 4 and 5 are applicable only to MicroPDF417 symbols.
Japan postal	X	9

5.11 GS1-128 Application Identifier

WB2F supports Application Identifier (AI) of GS1. Refer to the following table about a symbol and the version to support. AI is established by GS1 which is an international organization managing the international standard. Check the official website of GS1 about more information of AI.

Support symbol	Support version
GS1-128	2014 - 2016 version

5.12 Initialization Barcode

The Initialization barcode, when scanned, returns the WB2F to its factory default settings

If the configuration barcode is read in maintenance mode with the READ/ENTER button, the WB2F settings will be initialized to the factory defaults.

Initialization Barcode

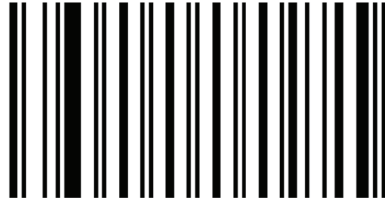

Be aware that the initialization barcode cannot be read using external input or control commands.



To switch to maintenance mode, refer to  [4. 4. 1 Switching operation to maintenance mode] on page 4-50.

5.13 Sample labels

This section contains sample labels. Print them out and use them as necessary. The vertex coordinate (x1, y1) of each code is the upperleft coordinate of each symbol.

Code39

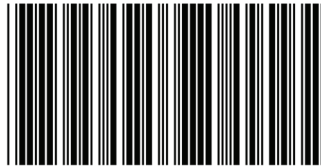

CODE-39

Codabar

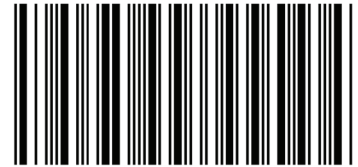

A123456789A

Interleaved 2of5



1234567890

Standard 2of5



1234567

UPC-A



1 23456 78901 2

JAN/EAN-13 (GTIN-13)



4 567890 123456

UPC-E0



0 123456 5

JAN/EAN-8 (GTIN-8)

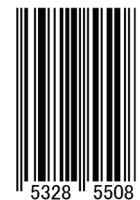

5328 5508

Code-128



Code-128

Code93



CODE 93

Code11



MSI Plessey



GS1 Databar Expanded



GS1 Databar Limited



GS1 Databar Omni-directional



GS1 Databar Expanded Stack



GS1 Databar Stack



GS1 Databar Limited Composite (CC-A)

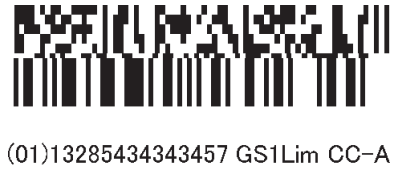

GS1 Databar Limited Composite (CC-B)



GS1-128 Composite (CC-C)



Japan Postal

1086014012

DataMatrixabcde0123456
789**QRCode**

QR Code

Micro QR Code

0123456789

PDF417

0123456789abcde

Micro PDF417

microPDF0123456789



The unit may not be able to read some symbols depending on its settings. When executing reading, change the settings to the appropriate setting values.

5.14 Installing the USB driver

Prior to using the maintenance port to connect the unit to a computer, the USB device driver must be installed.

The USB driver is made available on the IDEC website. Please download and install the latest USB driver from the IDEC website.

For details on the USB driver, refer to the included documentation.

5.15 Setting check digit

Each symbol has two settings, "Inspection of check digit Enabled/Disabled" and "Check digit transmitting Transmit/Not transmit". The settings that define the manner in which the WB2F operates are as follows.

The WB2F recognizes the last digit (excluding the start/stop characters) as the check digit when the check digit is defined in each symbology.

Inspection of check digit

- **Enabled : Check digit is inspected.**

The code can be read when the check result is correct, but cannot be read if the check result is incorrect.

- **Disabled : Check digit is not inspected.**

Since the check digit is not inspected, the code can be read whether or not the check digit is correct.

Check digit transmitting

- **Tranmit : Check digit is tranmitted.**

The check digit is tranmitted when the check digit is added to the barcode. The last digit is transmitted when the check digit is not added.

- **Not transmit : Check digit is not transmitted.**

The check digit is not transmitted when the check digit is added to the barcode. The last digit is not transmitted when the check digit is not added.

As an example, here is an explanation of barcode reading results when two options, "Check digit check Enabled/Disabled" and "Check digit transmitting Transmit/Not transmit", are used in different combinations.

e.g. Barcode without check digit

Configuration Item	Setting value
Symbology	Code39
Barcode data	1234567890
Check digit	Not added



Check digit		Reading results*	Remarks
Check	Transmitting		
Disabled	Not transmit	123456789	The last digit "0" is not output.
Disabled	Transmit	1234567890	It outputs the barcode data.
Enabled	Not transmit	Unreadable	The last digit "0" is recognized as the check digit and the code is checked. It may be read if it is checked correctly.
Enabled	Transmit	Unreadable	

* When decoder Code39 is set to "Start/stop character transmitting Disabled"

e.g. Barcode with check digit correctly added

Configuration Item	Setting value
Symbology	Code39
Barcode data	1234567890
Check digit	Added ("2")



Check digit		Reading results*	Remarks
Check	Transmitting		
Disabled	Not transmit	1234567890	Check digit "2" is not transmitted.
Disabled	Transmit	12345678902	Default
Enabled	Not transmit	1234567890	The code can be read since the check digit is correctly added.
Enabled	Transmit	12345678902	

* When decoder Code39 is set to "Start/stop character transmitting Disabled"

e.g. Barcode with check digit incorrectly added

Configuration Item	Setting value
Symbology	Code39
Barcode data	1234567890
Check digit	Added ("3")



12345678903

Check digit		Reading results*	Remarks
Check	Transmitting		
Disabled	Not transmit	1234567890	Check digit "3" is not transmitted.
Disabled	Transmit	12345678903	Default
Enabled	Not transmit	Unreadable	The code cannot be read since the check digit is incorrectly added.
Enabled	Transmit	Unreadable	

* When decoder Code39 is set to "Start/stop character transmitting Disabled"



- Check digit is effective to avoid incorrect reading.
- It is recommended to add the check digit to barcodes.

Index

A

Accessories.....	1-5
AIM symbology ID table.....	5-24
Angle Characteristics.....	5-5
ASCII Code Table.....	5-22
Autotuning.....	4-48

C

Check digit.....	5-32
Check digit calculation method.....	5-21
Checking the packaged product and the product configuration.....	1-1
Cleaning methods.....	vii
Cleaning the Scan Window.....	vii
Cleaning the unit.....	vii
Close.....	4-38
Command alias.....	4-26
Communication command.....	4-28
Communication Unit.....	4-92
Configuration Item Table.....	4-54
Confirming a Successful Read.....	3-3
Connecting the USB Cable	
Connecting the USB connector.....	2-15
USB connector pin assignment.....	2-15
Connecting to a PLC.....	4-53
Control Code Replacement.....	4-21
Control Command.....	4-29
Control Commands (Details).....	5-17
Custom tuning.....	4-48

D

Decoding Processing Time Measurement.....	4-45
Detailed Tuning.....	4-48
Dilate (Expansion).....	4-37
Dimensional outline drawings.....	5-7

E

Erode (Compression)	
.....	4-37
Examples: (Additional Information).....	4-18
External Input.....	4-40
External Output.....	4-40
External Output Timing Chart.....	5-11
BUSY Output.....	5-12
FLASH synchronous output.....	5-12
OK/NG Output.....	5-11
External Power Port.....	2-6
Extraction and Integration of Reading Result Data.....	4-20

F

Field of View.....	5-4
Firmware updating.....	4-52

G

GS1-128 Application Identifier.....	5-26
-------------------------------------	------

H

Histogram Equalization(averaging).....	4-38
--	------

I

Image Capture.....	4-34
Image Filter.....	4-37
Image quality.....	4-35
Imaging size.....	4-34
Initialization Barcode.....	5-27
Input/Output/RS-232/RS-422 port.....	2-6
Installation precautions.....	2-1
Installing the USB driver.....	5-31
I/O.....	4-40

L

List of Control Commands.....	5-13
-------------------------------	------

M

Maintenance mode.....	4-50
Detailed procedure using the READ/ENTER button.....	4-51
Maintenance support.....	4-52
Master Data Sequential Input.....	4-24
Master Mode.....	4-53
Master Mode transition by changing settings.....	4-53
Methods to fix the length of read symbols.....	4-88
Mounting methods	
WB2F mounting methods.....	2-3
Multiple Symbol Read (Differs from Multi-Read).....	4-12
Multi-Read Batch Output.....	4-10
Output format.....	4-16
Multi-Read Sequential Output.....	4-9
Output format.....	4-15

O

On keeping acquired images	4-36
Open	4-38
Operation mode	4-1
Operation mode switching operation and status	4-3
Output data additional information	4-15
During verification execution	4-17
Multiple Symbol Read	4-16
Multi-read Batch Output	4-16
Multi-read sequential outputMulti-read sequential output	4-15
Single Read	4-15
Output data editing	4-20

P

Parameter Changeover	4-31
Parameter Table Address Table	4-90
Part names and functions	
Communication Unit	4-93
WB2F	1-2
Performing an Operational Check using a PC	3-1
Connecting to a PC	3-2
Installing the Device Driver	3-1
Necessary operating environment of the PC	3-1
Peripheral Devices	1-5
Pitch	5-5
Precautions for Use	vi
Pre-registering Master Data	4-22
Product specifications	5-1

R

Reading Range	5-3
Reading Success Rate Measurement	4-44
Reading Success Sort	4-33
Read Parameter Table Changeover	4-32
Registering an Alias	4-26

S

Safety precautions	v
Sample labels	5-28
Scanner Port	2-5
Scan Operation Timing Chart	5-10
Sequence Mode	4-32
Setup Command	4-30
Setup support mode	4-41
Detailed procedure using the READ/ENTER and SELECT buttons	4-42
Setup symbol position	2-4
Sharpening	4-39

Single Read	4-6
Edge Activation	4-7
Level Activation	4-8
Output format	4-15
Skew	5-5
Slave Mode	4-4
Smoothing	4-39
Specify Table mode	4-32
Standard tuning	4-48
Start Reading and Stop Reading conditions for each Reading Request	4-11
Symbol Position Measurement	4-46
Symbol Read Data Confirmation	3-4
Symbol reading	4-5
Symbol Reading	4-6
Symbol Reading Method	4-5
System configuration	1-3

T

The relationship between Symbol placement and the Position LED	4-47
Tilt	5-6
Timing Chart	5-10
Troubleshooting	5-9

V

Verification	4-22
Verification Determination	4-25

W

WB2F mounting methods	2-3
Wiring	2-5
Wiring Instructions: Connecting the WB2F to the Communication Unit	
Connecting the Power Supply	2-7
Connecting to the WB2F	2-5
Connector Pin Assignment	2-5
RS-232 wiring	2-9
RS-422 wiring	2-9
Wiring for Ethernet Communication	2-10
Wiring for External Input	2-11
Wiring for External Output	2-11
Wiring Instructions: Setting up the WB2F without the Communication Unit	
Connector Pin Assignment	2-12
RS-232 wiring	2-13
Wiring for External Input	2-14
Wiring for External Output	2-14
Wiring the power supply	2-13

Revision history

Edition	Published	Revised content	
		Page	Points
1st	2017.3	-	-

WB2F 2D Code Scanner

User's Manual

- B-1952(0)
- Published: March 2017 1st edition
- 6-64, Nishi-Miyahara 2-Chome, Yodogawa-ku, Osaka, Japan

IDEC CORPORATION © 2017 IDEC CORPORATION All Rights Reserved.

- The specifications and content in this manual may be changed without prior notification.
- Reproduction of this manual without prior permission is prohibited. All rights reserved.

IDEC CORPORATION

 www.idec.com

Head Office

6-64, Nishi-Miyahara-2-Chome, Yodogawa-ku, Osaka 532-0004, Japan

USA	IDEC Corporation	Tel: +1-408-747-0550	opencontact@idec.com	Hong Kong	IDEC Izumi (H.K.) Co., Ltd.	Tel: +852-2803-8989	info@hk.idec.com
Australia	IDEC Australia Pty. Ltd.	Tel: +61-3-8523-5900	sales@au.idec.com	China/Shanghai	IDEC (Shanghai) Corporation	Tel: +86-21-6135-1515	idec@cn.idec.com
Germany	IDEC Electrotechnik GmbH	Tel: +49-40-25 30 54 - 0	service@eu.idec.com	China/Shenzen	IDEC (Shenzen) Corporation	Tel: +86-755-8356-2977	idec@cn.idec.com
Singapore	IDEC Izumi Asia Pte. Ltd.	Tel: +65-6746-1155	info@sg.idec.com	China/Beijing	IDEC (Beijing) Corporation	Tel: +86-10-6581-6131	idec@cn.idec.com
Thailand	IDEC Asia (Thailand) Co., Ltd	Tel: +66-2-392-9765	sales@th.idec.com	Japan	IDEC Corporation	Tel: +81-6-6398-2527	marketing@idec.co.jp
Taiwan	IDEC Taiwan Corporation	Tel: +886-2-2698-3929	service@tw.idec.com				

Specifications and other descriptions in this brochure are subject to change without notice.
2017 IDEC Corporation, All Rights Reserved.

B-1952(0) MARCH 2017





IDEC CORPORATION