

**FEATURES**

- (1) 5.6"WIDE-SVGA(1024x600 pixels) display size for mini-notebook PC or UMPC
- (2) LED Backlight (2 parallel connection)
- (3) Glare Surface
- (4) Wedge Shape

**TENTATIVE****MECHANICAL SPECIFICATIONS**

Item	Specifications
Dimensional Outline (typ.)	136.8(W) x 85.9* (H) x 2.95/4.6 (D) mm
Number of Pixels	1024 (W) x 600(H) pixels
Active Area	122.88(W) x 72.0(H) mm
Pixel Pitch	0.12(W) x 0.12(H) mm
Weight (approximately)	61 g
Backlight	LED

\*) Exclude mounting hole

**ABSOLUTE MAXIMUM RATINGS**

Item		Min.	Max.	Unit
Supply Voltage	(V <sub>DD</sub> )	-0.3	4.0	V
LED Forward Voltage <sup>*1</sup>	(V <sub>LED</sub> )	0	28.2	V
LED Backward Voltage <sup>*1</sup>		0	5.0	V
LED Currency (I <sub>LED</sub> )		-	30	mA
Input Signal Voltage (V <sub>IN</sub> )		-0.3	V <sub>DD</sub> +0.3	V
Operating Temperature		0	50	°C
Storage Temperature		-20	60	°C
Storage Humidity		10	90	%(RH)

\*1 : Per each LED strings

**ELECTRICAL SPECIFICATION**

Item		Min.	Typ.	Max.	Unit	Remarks
Supply Voltage	(V <sub>DD</sub> )	3.0	3.3	3.6	V	
Supply LED Voltage	(V <sub>LED</sub> )	20.0	24.8	28.2	V	@1 parallel
Common Mode Input Voltage	(V <sub>CM</sub> )	0.9	1.20	1.75	V	
Differential Input Amplitude	(V <sub>ID</sub> )	250	---	450	mV	
Current Consumption <sup>*4</sup>	(I <sub>DD</sub> ) <sup>*2</sup>	---	195		mA	
	(I <sub>LED</sub> ) <sup>*3</sup>	---	15	20	mA	@PWM=100%
Power Consumption <sup>*4</sup>		---	1.4	---	W	I <sub>LED</sub> =15 mA

\*2 : 8 color bars pattern

\*3 : The current value of each row should be the same value.

\*4 : The LED drive recommends to use the PWM drive.

**OPTICAL SPECIFICATION (T<sub>a</sub>=25°C)**

Item		Min.	Typ.	Max.	Unit	Remarks
Contrast Ratio (CR)		200	400	---	---	
Response Time	(t <sub>ON</sub> )+ (t <sub>OFF</sub> )	---	-	50	ms	
Luminance (L)		210	300	---	cd/m <sup>2</sup>	I <sub>LED</sub> =15mA

\*The information contained herein is presented only as a guide for the applications of our products. No responsibility is assumed by Toshiba Mobile Display Co., Ltd or other rights of the third parties which may result from its use. No license is granted by implication or otherwise under any patent or patent rights of Toshiba Mobile Display Co., Ltd or others.

\*The information contained herein may be changed without prior notice. It is therefore advisable to contact Toshiba Mobile Display Co., Ltd before proceeding with the design of equipment incorporating this product.

**DIMENSIONAL OUTLINE**  
(Front side)

**TENTATIVE**

Unit : mm  
Standard tolerance : ±0.5

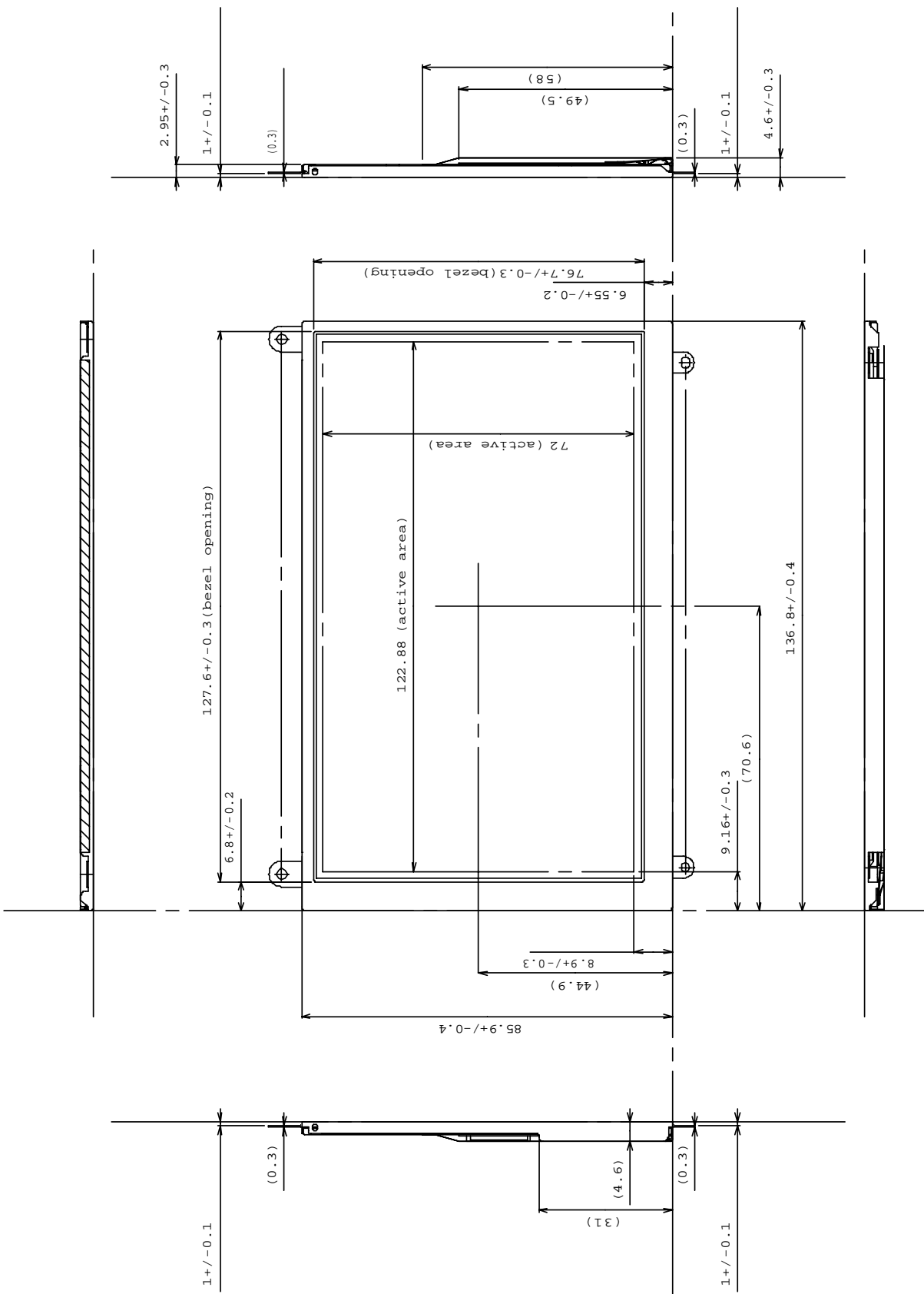

**DIMENSIONAL OUTLINE**

(Back side)

**TENTATIVE**

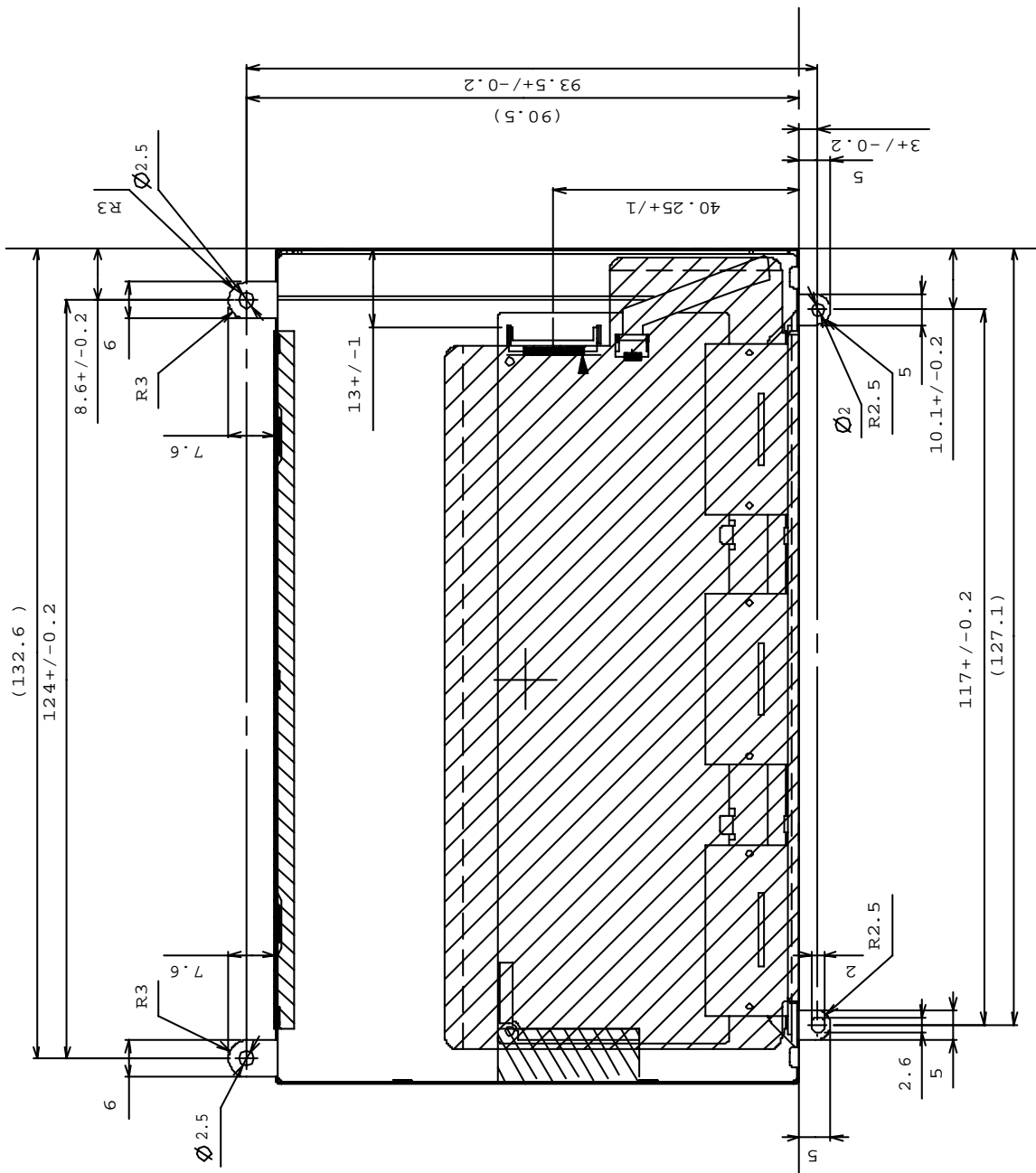

Note 1) Never push LCD back side. If LCD back side was pressed, It may cause damage of the back light system.

**BLOCK DIAGRAM**

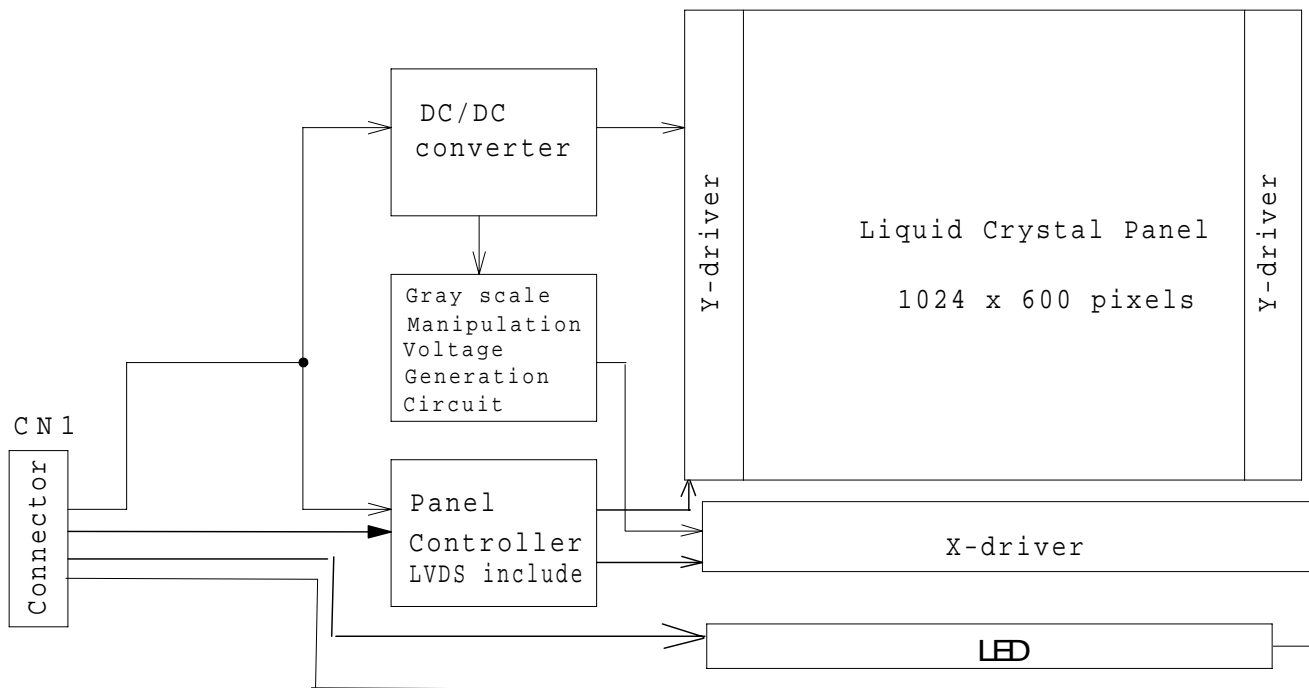

Note) LT056DET2S00 doesn't include LED driving circuits.  
LED driving circuits are necessary in customer side.

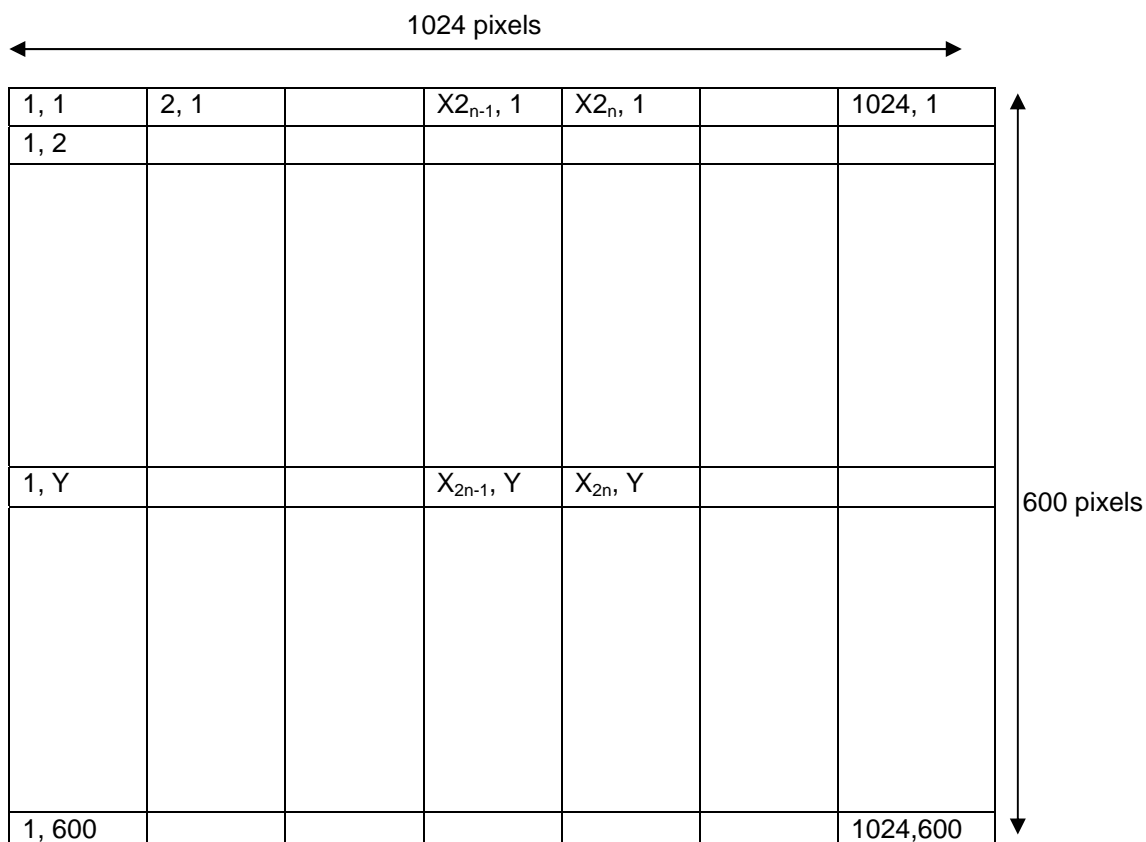

### Sequence of Power Supplies and Signals

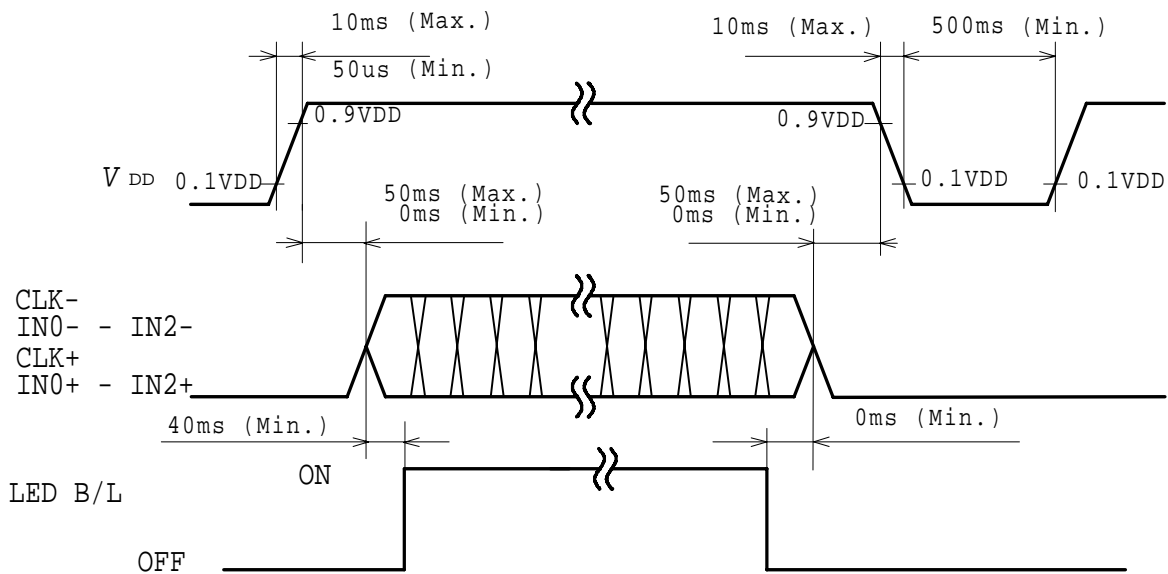

**TIMING CHART**

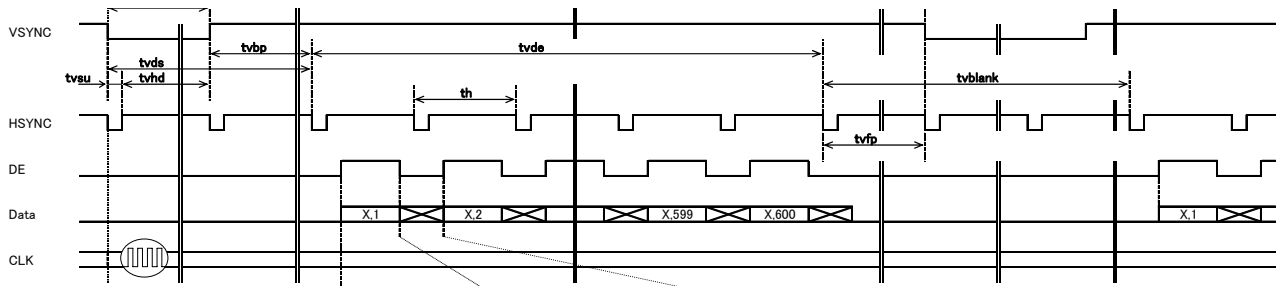

**(2) Horizontal Timing**

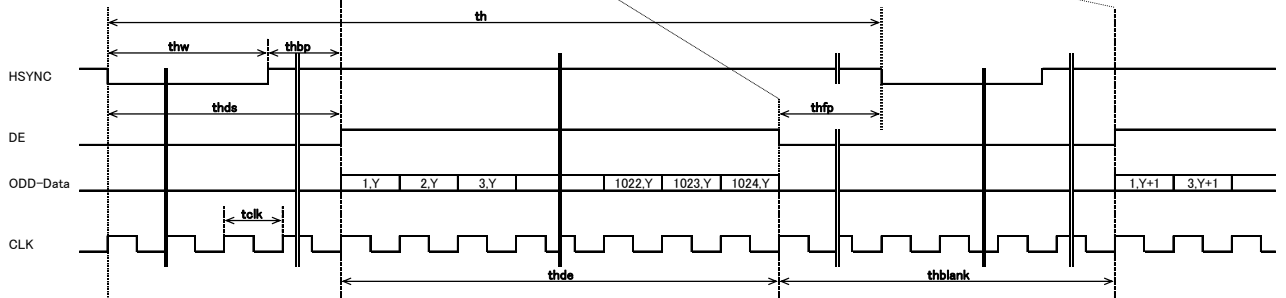

**TIMING SPECIFICATION** <sup>1) 2) 3) 4) 5) 6)</sup>

Item	Symbol	min	typ	max	Unit
Frame Period	tv	769	772	-	th
Vertical Display Term	tvd	600	600	600	th
Vertical Blanking Term	tvb	169	172	-	th
Horizontal Scanning Term	th	1160	1168	-	tc
Horizontal Display Term	thd	1024	1024	1024	tc
Horizontal Blanking Term	thb	136	144	-	tc
Clock Period	tc	15.38	18.52	-	ns
		65	54	-	MHz
V-sync Pulse Width	twv	1	4	-	th
Vertical Front Porch	tvfp	1	3	-	th
Vertical Back Porch	tvbp	2	165	-	th
H-sync Pulse Width	thw	8	32	-	tc
Horizontal Front Porch	thfp	8	48	-	tc
Horizontal Back Porch	thbp	16	64	-	tc
DE Pulse Width	thd	1024	1024	1024	tc

Note 1) Refer to "Timing Chart" and LVDS specifications in TIA/EIA-644.

Note 2) If DE is fixed to "H" or "L" level for certain period while NCLK is supplied, the panel displays black with some flicker.

Note 3) If NCLK is fixed to "H" or "L" level for certain period while DE is supplied, the panel may be damaged.

Note4)  $tvb = twv + tvfp + tvbp$

$thb = thw + thfp + thbp$

Note5) In case of using the long frame period, the deterioration of display quality, noise etc. may be occurred.

Note6) NCLK count of each Horizontal Scanning Time should be always the same.

V-Blanking period should be " $n$ " X "Horizontal Scanning Time". ( $n$ : integer)

Frame period should be always the same.

## CONNECTOR PIN ASSIGNMENT FOR INTERFACE

### CN1 INPUT SIGNAL

Connector : 20347-025E-02/I-PEX

Mating Connector : 20345-\*25T-##/I-PEX

Terminal No.	Symbol	Function
1	VAD	LED Anode (Positive)
2	NC	Non-Connection
3	VCD1	LED Cathode (Negative)
4	VCD2	LED Cathode (Negative)
5	NC	Non-Connection
6	V <sub>DD</sub>	Power Supply : +3.3V
7	V <sub>DD</sub>	Power Supply : +3.3V
8	V <sub>DD</sub>	Power Supply : +3.3V
9	NC	Non-Connection
10	V <sub>SS</sub>	GND
11	V <sub>SS</sub>	GND
12	V <sub>SS</sub>	GND
13	NC	Non-Connection
14	NC	Non-Connection
15	NC	Non-Connection
16	V <sub>SS</sub>	GND
17	RxIN0-	Negative LVDS differential data input (R0-R5,G0)
18	RxIN0+	Positive LVDS differential data input (R0-R5,G0)
19	RxIN1-	Negative LVDS differential data input (G1-G5, B0-B1)
20	RxIN1+	Positive LVDS differential data input (G1-G5, B0-B1)
21	RxIN2-	Negative LVDS differential data input (B2-B5, HSYNC, VSYNC, DE)
22	RxIN2+	Positive LVDS differential data input (B2-B5, HSYNC, VSYNC, DE)
23	RxCLKIN-	Clock Signal(-)
24	RxCLKIN+	Clock Signal(+)
25	V <sub>SS</sub>	GND

Note 1) Please connect GND pin to ground. Don't use it as no-connect nor connection with high impedance.

Note 2) Please connect NC to nothing. Don't connect it to ground nor to other signal input.



**RECOMMENDED TRANSMITTER (THC63LVDF83A,THC63LVDM83A,THC63LVDM83A-85)  
TO LT056DET2S00 INTERFACE ASSIGNMENT**

**Case1: 6bit Transmitter**

Input Terminal No.		Input Signal (Graphics controller output signal)		Output Signal Symbol	To LT056DET2S00 Interface(CN1)	
Symbol	Terminal	Symbol	Function		Terminal	Symbol
TA0	44	R0	Red Pixels Display Data (LSB)	TA- TA+	No.17 No.18	RxIN0- RxIN0+
TA1	45	R1	Red Pixels Display Data			
TA2	47	R2	Red Pixels Display Data			
TA3	48	R3	Red Pixels Display Data			
TA4	1	R4	Red Pixels Display Data			
TA5	3	R5	Red Pixels Display Data (MSB)			
TA6	4	G0	Green Pixels Display Data (LSB)	TB- TB+	No.19 No.20	RxIN1- RxIN1+
TB0	6	G1	Green Pixels Display Data			
TB1	7	G2	Green Pixels Display Data			
TB2	9	G3	Green Pixels Display Data			
TB3	10	G4	Green Pixels Display Data			
TB4	12	G5	Green Pixels Display Data (MSB)			
TB5	13	B0	Blue Pixels Display Data (LSB)	TC- TC+	No.21 No.22	RxIN2- RxIN2+
TB6	15	B1	Blue Pixels Display Data			
TC0	16	B2	Blue Pixels Display Data			
TC1	18	B3	Blue Pixels Display Data			
TC2	19	B4	Blue Pixels Display Data			
TC3	20	B5	Blue Pixels Display Data (MSB)			
TC4	22	HSYNC	H-Sync	TCLK - TCLK +	No.23 No.24	CLK IN- CLK IN+
TC5	23	VSYNC	V-Sync			
TC6	25	DE	Compound Synchronization Signal			
CLK IN	26	NCLK	Data Sampling Clock			

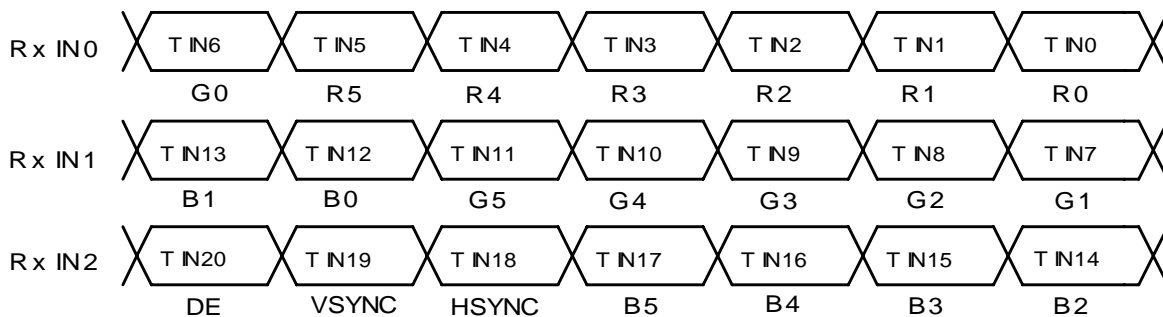

EQUIVALENT CIRCUIT OF LED

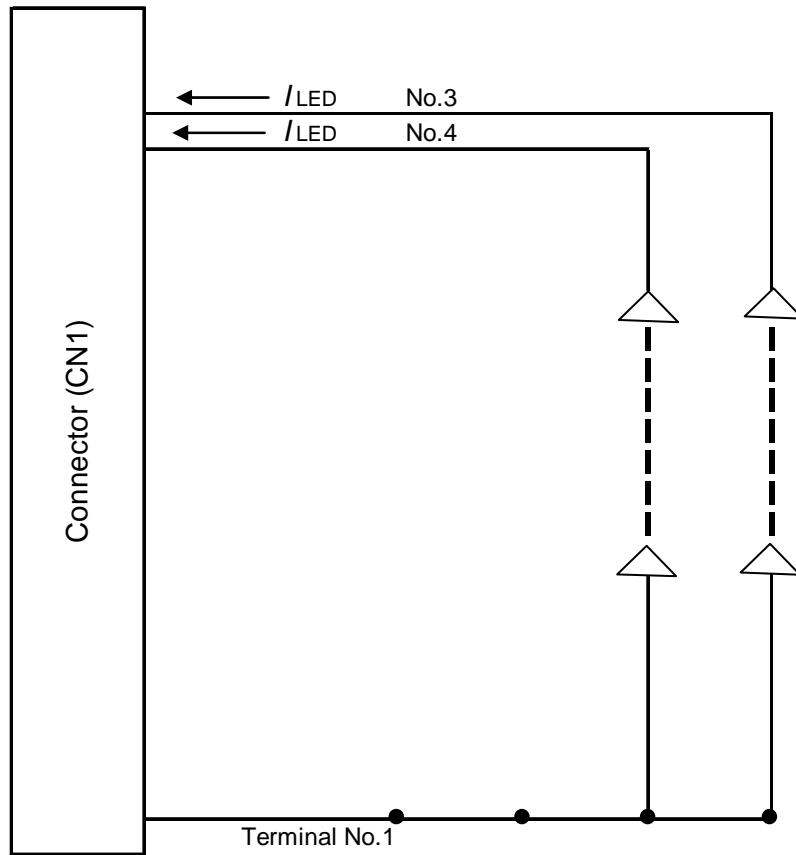

256k (k=1024) COLORS COMBINATION TABLE

	Display	R5 R4 R3 R2 R1 R0	G5 G4 G3 G2 G1 G0	B5 B4 B3 B2 B1 B0	Gray Scale Level
Basic Color	Black	L L L L L L L	L L L L L L L	L L L L L L L	-
	Blue	L L L L L L L	L L L L L L L	H H H H H H H	-
	Green	L L L L L L L	H H H H H H H	L L L L L L L	-
	Light Blue	L L L L L L L	H H H H H H H	H H H H H H H	-
	Red	H H H H H H H	L L L L L L L	L L L L L L L	-
	Purple	H H H H H H H	L L L L L L L	H H H H H H H	-
	Yellow	H H H H H H H	H H H H H H H	L L L L L L L	-
	White	H H H H H H H	H H H H H H H	H H H H H H H	-
Gray Scale of Red	Black	L L L L L L L	L L L L L L L	L L L L L L L	L 0
	Dark ↑ ↓ Light	L L L L L L H	L L L L L L L	L L L L L L L	L 1
		L L L L L H L	L L L L L L L	L L L L L L L	L 2
		⋮	⋮	⋮	L3... L60
	Light	H H H H L H	L L L L L L L	L L L L L L L	L61
		H H H H H L	L L L L L L L	L L L L L L L	L62
Red	H H H H H H H	L L L L L L L	L L L L L L L	Red L63	
Gray Scale of Green	Black	L L L L L L L	L L L L L L L	L L L L L L L	L 0
	Dark ↑ ↓ Light	L L L L L L L	L L L L L L H	L L L L L L L	L 1
		L L L L L L L	L L L L L H L	L L L L L L L	L 2
		⋮	⋮	⋮	L3... L60
	Light	L L L L L L L	H H H H L H	L L L L L L L	L61
		L L L L L L L	H H H H H L	L L L L L L L	L62
Green	L L L L L L L	H H H H H H H	L L L L L L L	Green L63	
Gray Scale of Blue	Black	L L L L L L L	L L L L L L L	L L L L L L L	L 0
	Dark ↑ ↓ Light	L L L L L L L	L L L L L L L	L L L L L L H	L 1
		L L L L L L L	L L L L L L L	L L L L H L	L 2
		⋮	⋮	⋮	L3... L60
	Light	L L L L L L L	L L L L L L L	H H H H L H	L61
		L L L L L L L	L L L L L L L	H H H H H L	L62
Blue	L L L L L L L	L L L L L L L	H H H H H H H	Blue L63	
Gray Scale of White & Black	Black	L L L L L L L	L L L L L L L	L L L L L L L	L 0
	Dark ↑ ↓ Light	L L L L L L H	L L L L L L H	L L L L L L H	L 1
		L L L L L H L	L L L L L H L	L L L L H L	L 2
		⋮	⋮	⋮	L3... L60
	Light	H H H H L H	H H H H L H	H H H H L H	L61
		H H H H H L	H H H H H L	H H H H H L	L62
White	H H H H H H H	H H H H H H H	H H H H H H H	White L63	

**FOR SAFETY**

LCD module is generally designed with precise parts to achieve light weighted thin mechanical dimensions.

In using our Modules, make certain that you fully understand and put into practice the warnings and safety precautions detailed in Engineering Information No.EE-D-001A,"CAUTIONS AND INSTRUCTIONS FOR TOSHIBA MOBILE DISPLAY CO., LTD LCD MODULES".

Refer to individual specifications and TECHNICAL DATA sheets (hereinafter called "TD") for more detailed technical information.

**1) SPECIAL PURPOSES**

A) Toshiba Mobile Display Co., Ltd 's Standard LCD Modules have not been customized for operation in extreme environments or for use in applications where performance failures could be life-threatening or otherwise catastrophic.

B) Since Toshiba Mobile Display Co., Ltd 's Standard LCD Modules have not been designed for operation in extreme environments, they must never be used in devices that will be exposed to abnormally high levels of vibration or shock which exceed Toshiba Mobile Display Co., Ltd 's published specification limits.

C) In addition, since Toshiba Mobile Display Co., Ltd Standard LCD Modules have not been designed for use in applications where performance failures could be life-threatening or catastrophic, they must never be installed in aircraft navigation control systems (such as, but not limited to Traffic Collision Avoidance System and Air Traffic Indicator), in military defense or weapons systems, in critical industrial process-control systems (e.g., those involved in the production of nuclear energy), or in critical medical device or patient life-support systems.

**2) DISASSEMBLING OR MODIFICATION**

DO NOT DISASSEMBLE OR MODIFY the module. It may damage sensitive parts inside LCD module, and may cause scratches or dust on the display.

Toshiba Mobile Display Co., Ltd does not warrant the module, if customer disassembled or modified it.

**3) BREAKAGE OF LCD PANEL**

DO NOT INGEST liquid crystal material, DO NOT INHALE this material, and DO NOT CONTACT the material with skin, if LCD panel is broken and liquid crystal material spills out.

If liquid crystal material comes into mouth or eyes, rinse mouth or eyes out with water immediately.

If this material contact with skin or cloths, wash it off immediately with alcohol and rinse thoroughly with water.

**4) GLASS OF LCD PANEL**

BE CAREFUL WITH CHIPS OF GLASS that may cause injuring fingers or skin, when the glass is broken.

**5) ELECTRIC SHOCK**

DISCONNECT POWER SUPPLY before handling LCD module.

DO NOT TOUCH the parts inside LCD module and the connector or cables in order to prevent electric shock, because high voltage is supplied to these parts from power supply is turned on.

**6) ABSOLUTE MAXIMUM RATINGS AND POWER PROTECTION CIRCUIT**

DO NOT EXCEED the absolute maximum rating values under the worst probable conditions caused by the supply voltage variation, input voltage variation, variation in parts' constants, environmental temperature, etc., otherwise LCD module may be damaged.

Employ protection circuit for power supply, whenever the specification or TD specifies it.

Suitable protection circuit should be applied for each system design.

**7) DISPOSAL**

When dispose LCD module, obey to the applicable environmental regulations.