

- RF SAW Filter, 2326.0 MHz
- 2.5 x 2.0 x 1.0 mm Surface-mount Case
- $Z_S = 50 \text{ ohm}$, $Z_L = 100 \text{ ohm}$
- Complies with Directive 2002/95/EC (RoHS)

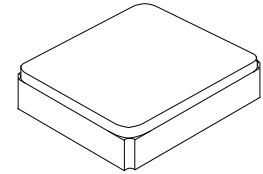

SF1220G

**2326.0 MHz
SAW Filter**



SM2520-5

Absolute Maximum Ratings

Rating	Value	Units
Maximum Input Power	+15	dBm
Maximum DC Voltage Between any Two Terminals	3	V
Operating Temperature Range	-40 to +85	°C
Storage Temperature Range in Tape and Reel	-40 to +85	°C
Maximum Soldering Profile	265°C for 10 s	

Electrical Characteristics

Characteristic	Sym	Notes	Min	Typ	Max	Units
Center Frequency	f_c		2326			MHz
Maximum Insertion Loss, 2319 to 2333 MHz	IL_{MAX}			2.7	3.2	dB
Amplitude Ripple, 2319 to 2333 MHz				0.4	1.0	dB _{P-P}
Group Delay Ripple, 2319 to 2333 MHz				7.3		ns _{P-P}
Group Delay, 2326 MHz				11		ns
VSWR, 2319 to 2333 MHz				1.85:1	2.1:1	
Return Loss, 2319 to 2333 MHz			6.5	9.6		dB
Source Impedance, Single Ended				50		Ω
Load Impedance, Balanced				100		Ω
Attenuation						
0.3 to 2175 MHz			39	47		dB
2175 to 2227 MHz			25	40		
2400 to 2426 MHz			15	24		
2426 to 2526 MHz			35	41		
2526 to 2700 MHz			40	46		

Case Style	SM2520-4
Lid Symbolization	3V



CAUTION: Electrostatic Sensitive Device. Observe precautions for handling.

NOTES:

1. US and international patents may apply.
2. Murata, stylized Murata logo, and Murata N.A., Inc. are registered trademarks of Murata Manufacturing Co., Ltd.

Filter Amplitude Response, 500 MHz Span:

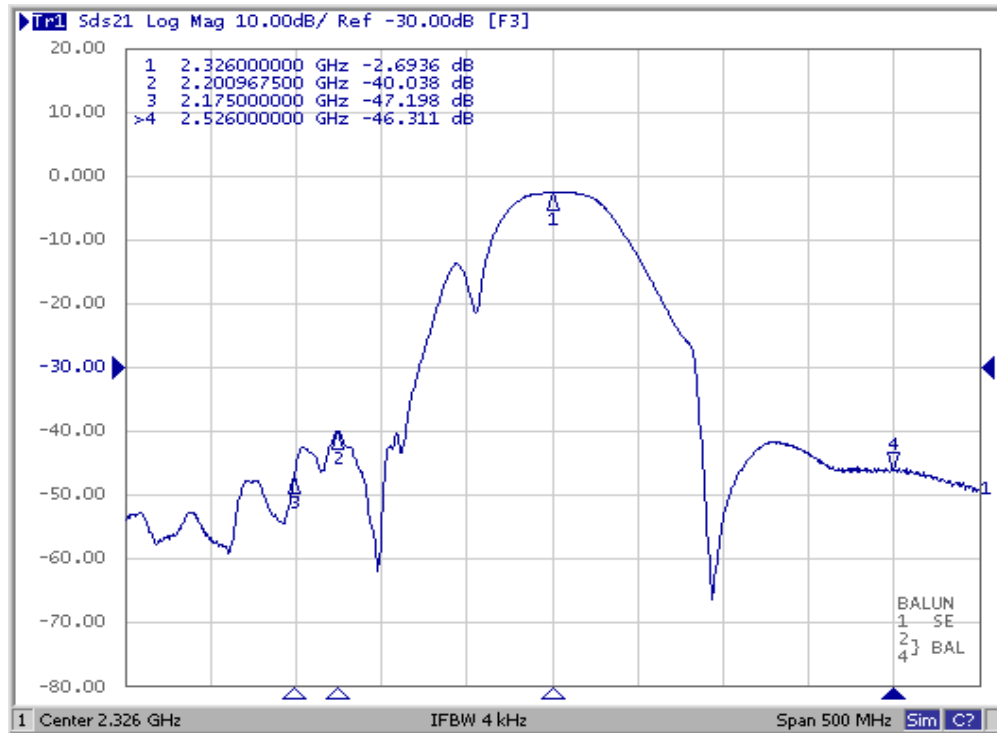

Test Circuit

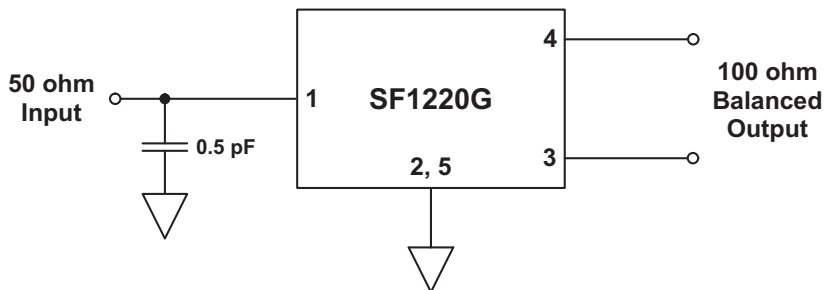

Filter Amplitude and Group Delay Response, 100 MHz Span:

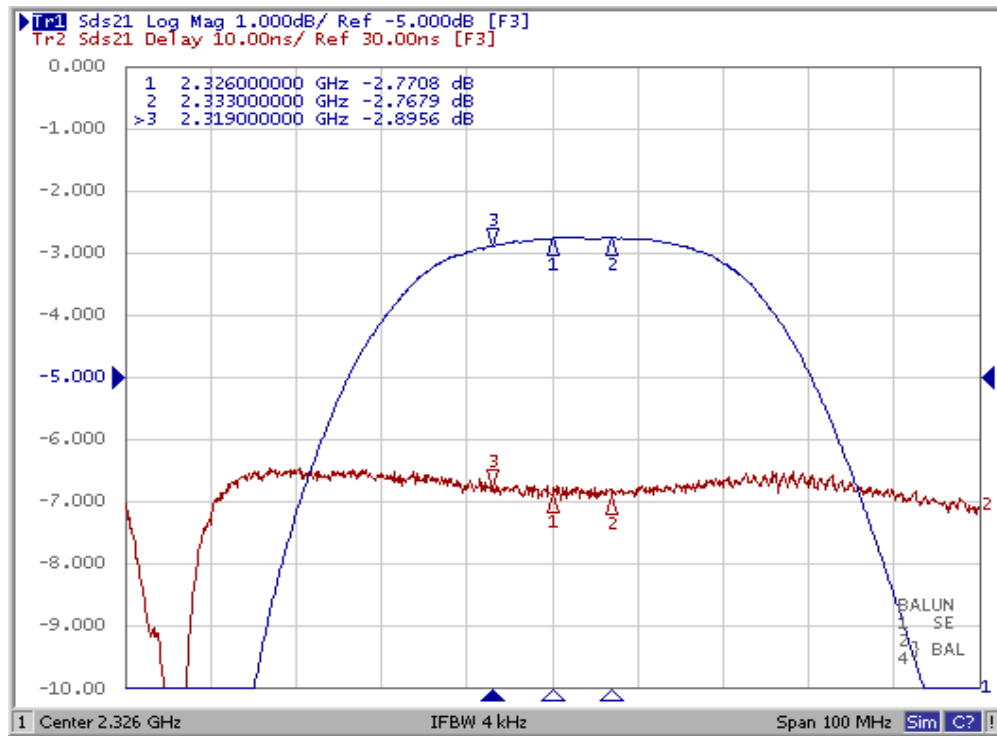

Input VSWR Plot:

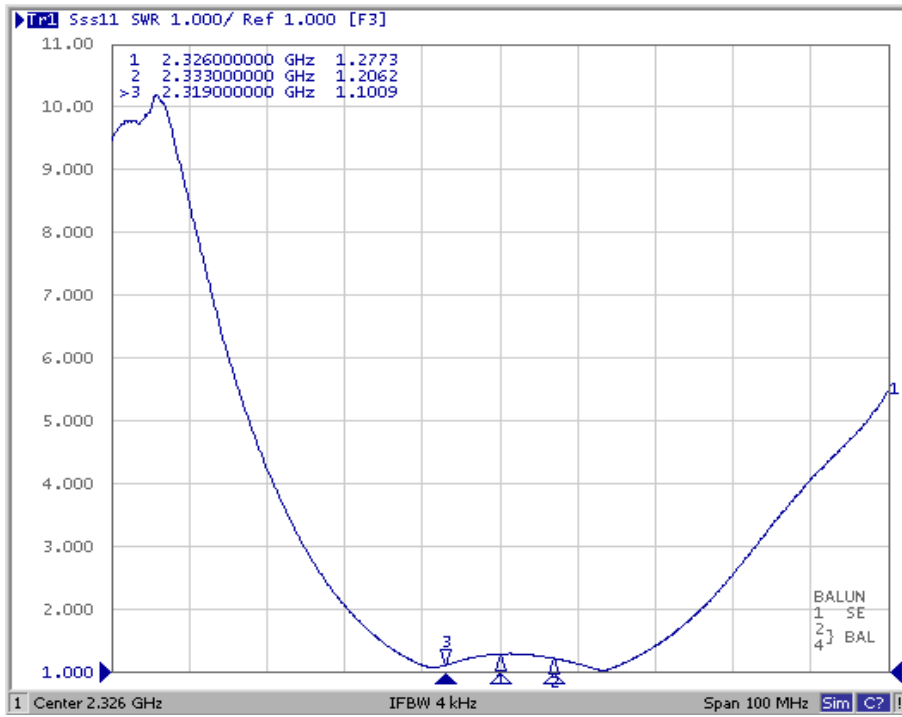

Output VSWR Plot:

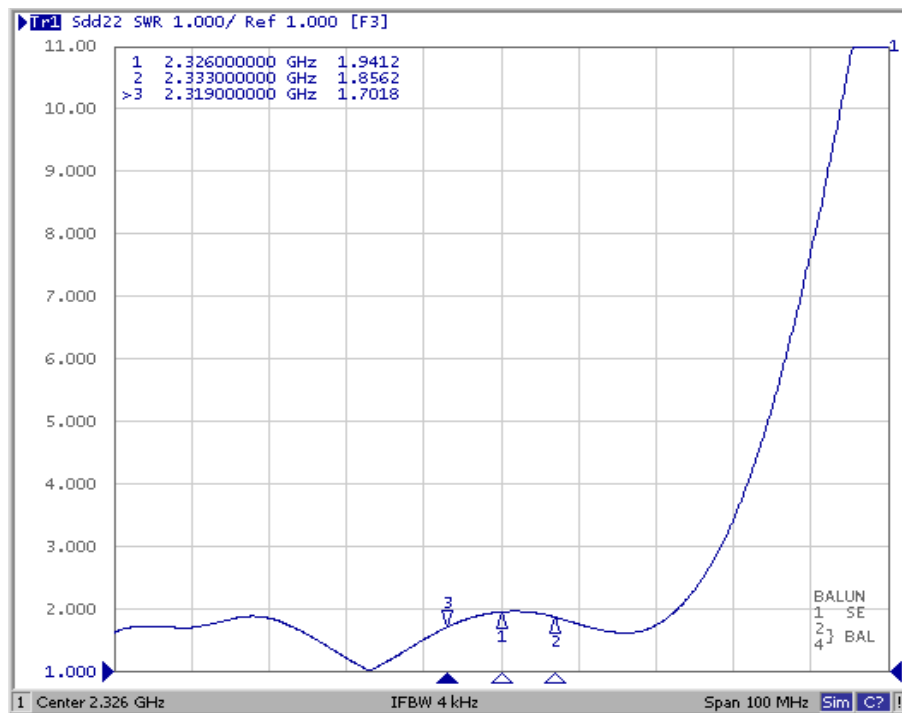

SM2520-5 Case

5-Terminal Ceramic Surface-mount Case 2.5 X 2.0 mm Nominal Footprint

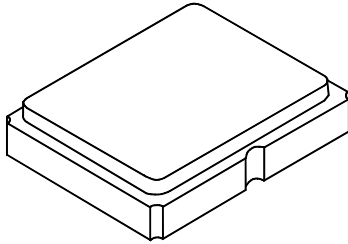

PCB Footprint

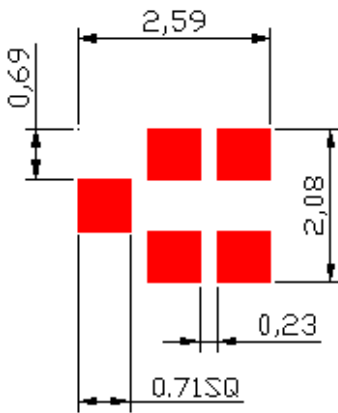

TOP VIEW

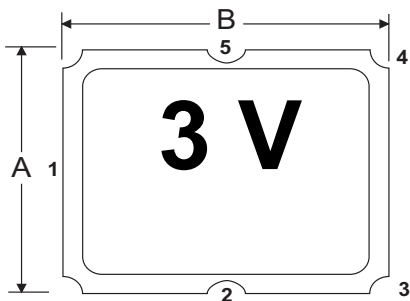

BOTTOM VIEW

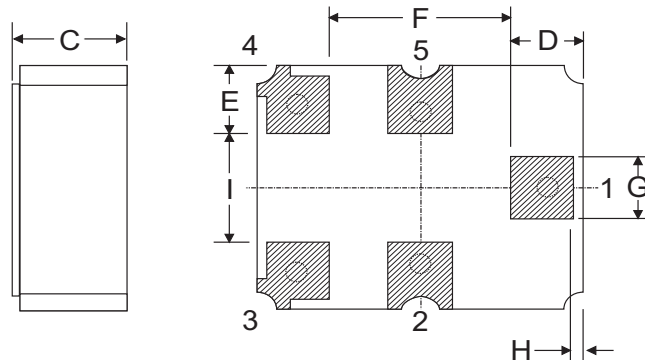

Case Dimensions

Dimension	mm			Inches		
	Nom			Nom		
A	1.88	2.00	2.12	0.074	0.079	0.083
B	2.38	2.50	2.62	0.094	0.098	0.103
C	0.92	1.00	1.08	0.036	0.039	0.043
D	0.42	0.55	0.68	0.017	0.022	0.027
E	0.42	0.55	0.68	0.017	0.022	0.027
F	1.27	1.40	1.53	0.050	0.055	0.060
G	0.37	0.50	0.63	0.015	0.020	0.025
H	0.06	0.08	0.10	0.002	0.003	0.004
I	0.77	0.90	1.03	0.030	0.035	0.041

Case Material

Materials	
Solder Pad Plating	0.3 to 1.0 μm Gold over 1.27 to 8.89 μm Nickel
Lid Plating	2.0 to 3.0 μm Nickel
Body	Al_2O_3 Ceramic
Pb Free	

Electrical Connections

Connection	Terminals
Input	1
Output	3, 4
Ground	2, 5

Reel Dimension

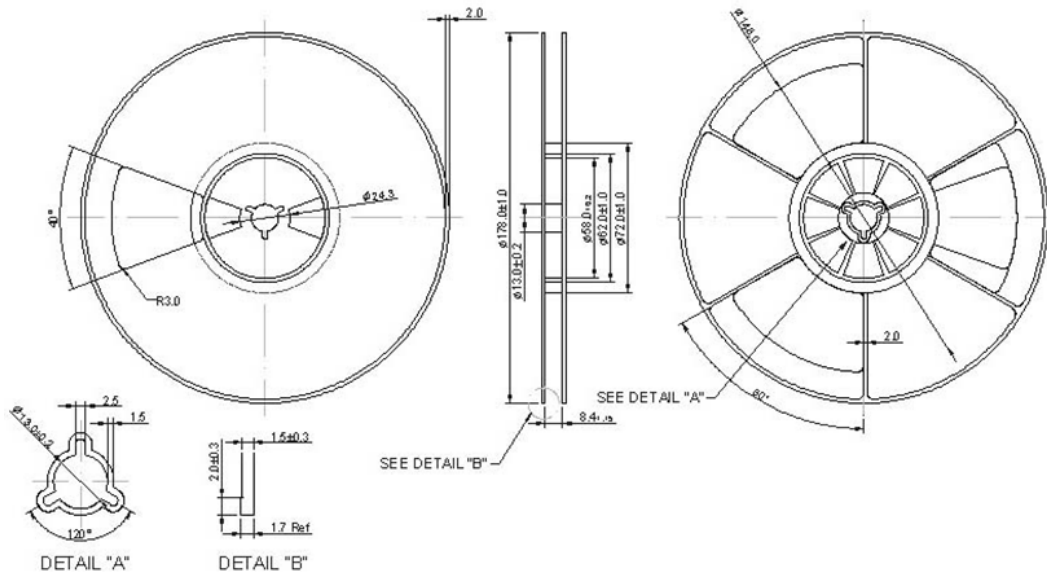

Tape Dimension

