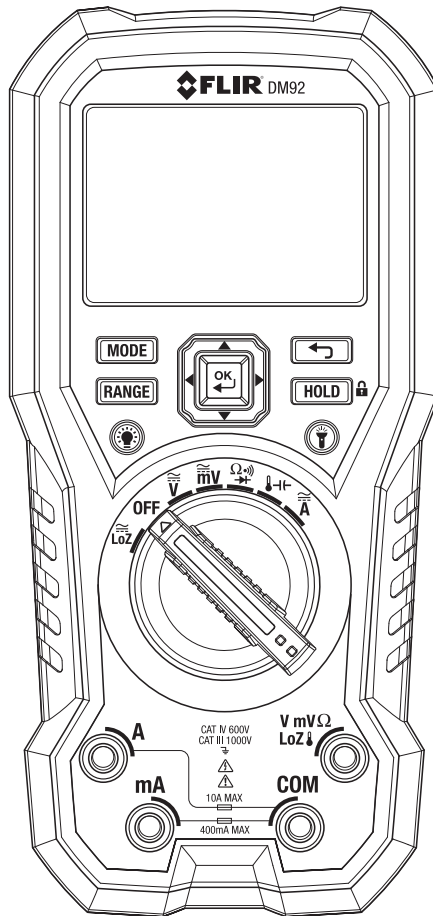

**FLIR MODEL DM92****True RMS Industrial Multimeter**

# Table of Contents

---

<b>1. DISCLAIMERS</b>	<b>4</b>
1.1 Copyright	4
1.2 Quality Assurance	4
1.3 Documentation	4
1.4 Disposal of Electronic Waste	4
<b>2. SAFETY</b>	<b>5</b>
<b>3. INTRODUCTION</b>	<b>7</b>
3.1 Key Features	7
<b>4. METER DESCRIPTION</b>	<b>8</b>
4.1 Meter Sections	8
4.2 Function Switch Positions	9
4.3 Function Buttons, Selector Pad, and Rotary Switch	9
4.4 Display Description	10
4.5 Display Icons and Indicators	10
<b>5. OPERATION</b>	<b>13</b>
5.1 Powering the Meter	13
5.2 Auto/Manual Select Mode	13
5.3 Auto/Manual Range Mode	14
5.4 Voltage Measurements	14
5.5 Resistance Measurements	14
5.6 Continuity Test	15
5.7 Diode Test	15
5.8 Capacitance Measurements	15
5.9 Type K Temperature Measurements	16
5.10 Current Measurements	16
5.11 Extended Functionality	17
5.12 Normal Hold Mode and Auto Hold Mode	20
5.13 Locked Mode	20

<b>6.</b>	<b>MAINTENANCE</b>	<b>21</b>
6.1	Cleaning and Storage	21
6.2	Battery Replacement	21
6.3	Fuse Replacement	21
6.4	Disposal of Electronic Waste	21
<b>7.</b>	<b>SPECIFICATIONS</b>	<b>22</b>
7.1	General specifications	22
7.2	Electrical Range Specifications	23
<b>8.</b>	<b>TECHNICAL SUPPORT</b>	<b>28</b>
<b>9.</b>	<b>WARRANTIES</b>	<b>28</b>
9.1	FLIR Global Limited Lifetime Warranty	28
9.2	FLIR Test and Measurement Limited 2 Year Warranty	29

# 1. Disclaimers

---

## 1.1 Copyright

© 2014, FLIR Systems, Inc. All rights reserved worldwide. No parts of the software including source code may be reproduced, transmitted, transcribed or translated into any language or computer language in any form or by any means, electronic, magnetic, optical, manual or otherwise, without the prior written permission of FLIR Systems.

The documentation must not, in whole or part, be copied, photocopied, reproduced, translated or transmitted to any electronic medium or machine readable form without prior consent, in writing, from FLIR Systems.

Names and marks appearing on the products herein are either registered trademarks or trademarks of FLIR Systems and/or its subsidiaries. All other trademarks, trade names or company names referenced herein are used for identification only and are the property of their respective owners.

## 1.2 Quality Assurance

The Quality Management System under which these products are developed and manufactured has been certified in accordance with the ISO 9001 standard.

FLIR Systems is committed to a policy of continuous development; therefore we reserve the right to make changes and improvements on any of the products without prior notice.

## 1.3 Documentation

To access the latest manuals and notifications, go to the Download tab at: <http://support.flir.com>. It only takes a few minutes to register online. In the download area you will also find the latest releases of manuals for our other products, as well as manuals for our historical and obsolete products.

## 1.4 Disposal of Electronic Waste



As with most electronic products, this equipment must be disposed of in an environmentally friendly way, and in accordance with existing regulations for electronic waste.

Please contact your FLIR Systems representative for more details.

## 2. Safety

---

### Safety Notes

- Before operating the device, you must read, understand, and follow all instructions, dangers, warnings, cautions, and notes.
- FLIR Systems reserves the right to discontinue models, parts or accessories, and other items, or to change specifications at any time without prior notice.
- Remove the batteries if the device is not used for an extended period of time.





### Warning Statements

- Do not operate the device if you do not have the correct knowledge. Formal qualifications and/or national legislation for the electrical inspections can apply. Incorrect operation of the device can cause damage, shock, injury or death to persons.
- Do not start the measuring procedure before you have set the function switch to the correct position. This can cause damage to the instrument and can cause injury to persons.
- Do not change to resistance when you measure the voltage. This can cause damage to the instrument and can cause injury to persons.
- Do not measure the current on a circuit when the voltage increases to more than 1000 V. This can cause damage to the instrument and can cause injury to persons.
- You must disconnect the test leads from the circuit that you did a test on before you change the range. If you do not do this, damage to the instrument and injury to persons can occur.
- Do not replace the batteries before you remove the test leads. This can cause damage to the instrument and can cause injury to persons.
- Do not use the device if the test leads and/or the device show signs of damage. Injury to persons can occur.
- Be careful when you do the measurements if the voltages are more than 25 VAC rms or 35 VDC. There is a risk of shock from these voltages. Injury to persons can occur.
- Do not do diode, resistance or continuity tests before you have removed the power from capacitors and other devices under test during a measurement. Injury to persons can occur.
- Do not use the device as a tool to identify live terminals. You must use the correct tools. Injury to persons can occur if you do not use the correct tools.
- Make sure that children cannot touch the device. The device contains dangerous objects and small parts that children can swallow. If a child swallows an object or a part, speak with a physician immediately. Injury to persons can occur.
- Do not let children play with the batteries and/or the packing material. These can be dangerous for children if they use them as toys.
- Do not touch expired or damaged batteries without gloves. Injury to persons can occur.
- Do not cause a short-circuit of the batteries. This can cause damage to the instrument and can cause injury to persons.
- Do not put the batteries into a fire. Injury to persons can occur.

## Cautions

Do not use the device for a procedure that it is not made for. This can cause damage to the protection.

	This symbol, adjacent to another symbol or terminal, indicates that the user must refer to the manual for further information.
	This symbol, adjacent to a terminal, indicates that, under normal use, hazardous voltages may be present.
	Double insulation.



UL listing is not an indication or a verification of the accuracy of the meter

## 3. Introduction

---

Thank you for selecting the FLIR DM92 Digital MultiMeter.

This device is shipped fully tested and calibrated and, with proper use, will provide years of reliable service.

### 3.1 Key Features

- 4000/40 000 counts extra-large digital dual display.
- Auto selection AC/DC in voltage and current modes.
- On-screen menu selection and navigator key drive
- Variable-frequency drive mode (low-pass filter).
- 0.05% DCV accuracy.
- Low-Z measurement.
- Auto hold.
- Peak hold measurement.
- dB/dBm measurement.
- 99-record manual data record / recall memory.
- Indoor use only; 6561' (2000m).
- Safety Category Rating: CAT IV-600V, CAT III-1000V.

## 4. Meter Description

### 4.1 Meter Sections

1. Courtesy Work Lights
2. LCD Display
3. MODE Button
4. RANGE Button
5. Backlight Button
6. Function Buttons (detailed below)
7. EXIT Button
8. HOLD / Lock Button
9. Work Light Button
10. Rotary Function Switch
11. Positive (+) Probe Input Jack for A (Current).
12. Positive (+) Probe Input Jack for mA (Current).
13. COM (negative -) Probe Input Jack
14. Positive (+) Probe Input Jack for V, mV,  $\Omega$ , and LoZ and Temperature

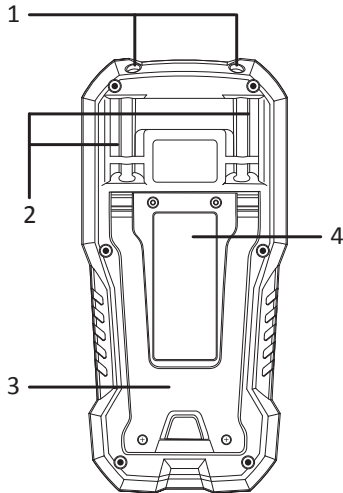

Fig 4-2 Rear View

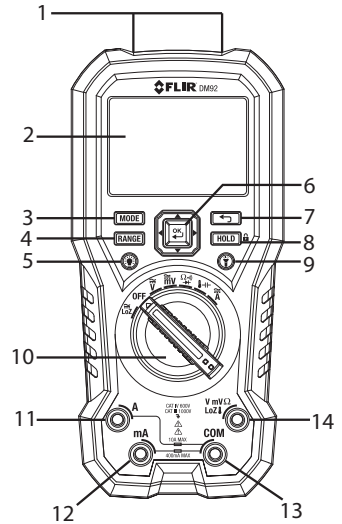







Fig 4-1 Front View







1. Courtesy Work Lights
2. Test Probe Holders
3. Tilt Stand
4. Battery Compartment Cover



## 4.2 Function Switch Positions

<b>LoZ</b>	The meter can measure voltage through the probe inputs. A low-impedance load is placed across the inputs to stabilize the measurement.
<b>OFF</b>	The meter is switched OFF and in full power-saving mode.
	The meter can measure voltage (V) through the probe inputs.
	The meter can measure low voltage (mV) through the probe inputs.
	The meter can measure resistance, continuity, or diode polarity through the probe inputs. The type of measurement is selected by the <b>MODE</b> button.
	The meter can measure capacitance through the probe inputs or temperature through a thermocouple adapter. The type of measurement is selected by the <b>MODE</b> button.
	The meter can measure current through the probe inputs.

## 4.3 Function Buttons, Selector Pad, and Rotary Switch

	<ul style="list-style-type: none"> <li>Use this button to select Auto select or Manual select mode, see section 5.2 <i>Auto/Manual select mode</i>.</li> <li>In manual select mode, press the button to change the operating mode.</li> </ul>
	<ul style="list-style-type: none"> <li>Use this button to select Auto range or Manual range mode, see section 5.3 <i>Auto/Manual range mode</i>.</li> <li>In Manual range mode, press the button to change the range (scale).</li> </ul>
	<ul style="list-style-type: none"> <li>Press the button to toggle between Normal and Hold mode, see section 5.12 <i>Normal hold mode and Auto hold mode</i>.</li> <li>Press and hold the button for 5 seconds to enable/disable Locked mode, see section 5.13 <i>Locked mode</i>.</li> </ul>
	Use this selector pad to enable extended functionality modes and to navigate in mode options.
	Press this button to exit an extended functionality mode.
	Press this button to enable/disable the display backlight.
	Press this button to enable/disable the work lights.



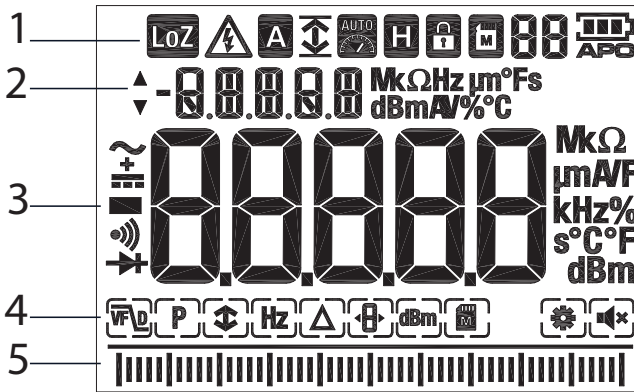

## 4.4 Display Description

















Fig 4-3 Display snapshot









1. Mode and Status icons
2. Secondary Display
3. Main Display
4. Advanced function icons
5. Bar graph (matches the reading on the main display)

## 4.5 Display Icons and Indicators

LoZ	Indicates that the meter is measuring stabilized voltage.
	Indicates that the measured voltage is greater than 30 V (AC or DC).
	Indicates that the Auto select mode is active.
	Indicates that the meter is displaying maximum reading values.
	Indicates that the meter is displaying minimum reading values.
	Indicates that the meter is displaying the average reading.

	Indicates that the meter is displaying peak maximum values.
	Indicates that the meter is displaying peak minimum values.
	Indicates that the meter is in Auto range mode.
	Indicates that the meter is in Hold mode.
	Indicates that the meter is in Locked mode.
	Indicates the active memory location (1-99).
	Indicates the battery voltage status.
	Indicates that the auto power off function is enabled.
	Indicates that the meter is measuring AC current or voltage.
	Indicates that the meter is measuring DC current or voltage.
	Indicates that the meter is measuring AC + DC current or voltage.
	Indicates that the continuity function is active.
	Indicates that the diode test function is active.
	VFD mode icon.
	Peak mode icon.
	Min/Max/Avg mode icon.
	Frequency mode icon.

	Relative mode icon.
	4000/40 000 digit selection.
	dBm mode icon.
	99-point Manual Data Recording mode icon.
	Setup mode icon.
	Silent mode icon.

#### **4.5.1 Probe Indicator**

When the probe leads are not plugged into the correct jack sockets for the measurement selected by the function switch, *PROBE* is displayed.

#### **4.5.2 Out-of-range warning**

If the input is over/under the full-scale range in Manual range mode, or if the signal has exceeded the maximum/minimum input in Auto range mode, *OL* is displayed.

## 5. Operation

---

**Note:** Before operating the device, you must read, understand, and follow all instructions, dangers, warnings, cautions, and notes.

**Note:** When the meter is not in use, the function switch should be set to the OFF position.

**Note:** When connecting the probe leads to the device under test, connect the COM (negative) lead before connecting the positive lead. When removing the probe leads, remove the positive lead before removing the COM (negative) lead.

### 5.1 Powering the Meter

1. Set the function switch to any position to switch on the meter.
2. If the battery indicator  shows that the battery voltage is low or if the meter does not power on, replace the battery. See section 6.2 *Battery Replacement*.

#### 5.1.1 Auto Power Off

The meter enters sleep mode after a programmable number of minutes of inactivity, see section 5.11.9 *Setup mode*.

The meter beeps three times 10 seconds before powering off. Press any button or turn the Rotary Switch to prevent the meter from powering off. The auto power off time-out is then reset.

### 5.2 Auto/Manual Select Mode

In Auto select mode, the meter attempts to automatically select the proper operating mode based on the input signal:

If the function switch is set to the  $\text{LoZ}$ ,  $\tilde{\text{V}}$ ,  $\tilde{\text{mV}}$ , or  $\tilde{\text{A}}$  position, the meter attempts to determine if the AC or DC mode should be used.

Auto select mode is the default mode of operation. When a new function is selected with the function switch, the starting mode is Auto select and the **A** indicator is displayed.

To enter Manual select mode, press the  button. To manually select the operating mode, press the  button repeatedly.



To enter Auto select mode, press and hold the  button until the **A** indicator is displayed.

**Note:** Note that the DM92 Data Recording feature cannot be used when the meter is in the Auto Select Mode. To use the Data Recorder please set the meter to the Manual Select mode first.

## 5.3 Auto/Manual Range Mode







In Auto range mode, the meter automatically selects the most appropriate measurement scale. In Manual range mode, the desired range (scale) is set manually.

Auto range mode is the default mode of operation. When a new function is selected with the function switch, the starting mode is Auto range and the  indicator is displayed.

To enter Manual range mode, press the  button. To change the range, press the  button repeatedly until the desired range is displayed.

To enter Auto range mode, press and hold the  button until the  indicator is displayed.



## 5.4 Voltage Measurements

- Set the function switch to one of the following positions:
  -  for high voltage measurements.
  -  for low voltage measurements.
  - LoZ** for voltage measurements using the meter's low input impedance mode. The **LoZ** indicator is displayed.
- Insert the black probe lead into the negative **COM** terminal and the red probe lead into the positive  terminal.
- Use the  button to select AC, DC, or AC + DC voltage measurement.
  - The  indicator will be displayed for AC measurements.
  - The  indicator will be displayed for DC measurements.
  - The  indicator will be displayed for AC + DC measurements.
- Connect the probe leads in parallel to the part under test.
- Read the voltage value on the display.

## 5.5 Resistance Measurements

**Warning:** Do not do diode, resistance or continuity tests before you have removed the power from capacitors and other devices under test during a measurement. Injury to persons can occur.

- Set the function switch to the  position.
- Ensure that the meter is set to resistance measurement. The  $\Omega$  unit will be displayed.

If the  or  indicator is displayed, press the  button repeatedly until the  $\Omega$  unit is displayed.

- Insert the black probe lead into the negative **COM** terminal and the red probe lead into the positive  terminal.
- Touch the tips of the probe across the circuit or component under test.
- Read the resistance value on the display.

## 5.6 Continuity Test

**Warning:** Do not do diode, resistance or continuity tests before removing the power from capacitors and other devices under test during a measurement. Injury to persons can occur.

1. Set the function switch to the  $\Omega \rightarrow \bullet$  position.
2. Use the **MODE** button to select continuity measurement. The  $\bullet \rightarrow$  indicator will be displayed.
3. Insert the black probe lead into the negative **COM** terminal and the red probe lead into the positive  $\overset{V_{mV\Omega}}{LoZ}$  terminal.
4. Touch the tips of the probe across the circuit or component under test.
5. If the resistance is  $30 \pm 5 \Omega$  (nominal) or less, the meter beeps.

**Note:** This threshold is user selectable in the *SET UP* menu under the *Cntin (continuity)* setting: Range: 10-50  $\Omega$ ; Increment: 1; Default: 30  $\Omega$ .

## 5.7 Diode Test

**Warning:** Do not do diode, resistance or continuity tests before you have removed the power from capacitors and other devices under test during a measurement. Injury to persons can occur.

1. Set the function switch to the  $\Omega \rightarrow \bullet$  position.
2. Use the **MODE** button to select the diode test function. The  $\rightarrow \bullet$  indicator will be displayed.
3. Insert the black probe lead into the negative **COM** terminal and the red probe lead into the positive  $\overset{V_{mV\Omega}}{LoZ}$  terminal.
4. Touch the tips of the probe across the diode or semiconductor junction under test. Make a note of the value on the display.
5. Reverse the polarity of the probes, by interchanging the probe test locations.
6. Touch the tips of the probe across the diode or semiconductor junction under test. Make a note of the new value on the display
7. The diode or semiconductor junction can be evaluated as follows:
  - If one of the readings displays a value (typically 0.400 V or 0.900 V) and the other reading displays *OL*, the component is good.
  - If both readings display *OL*, the component is open.
  - If both readings are very small or 0, the component is shorted.

## 5.8 Capacitance Measurements

**Warning:** Do not do capacitance tests before removing the power to the capacitor or other devices under test during a measurement. Injury to persons can occur.

1. Set the function switch to the  $\bullet \rightarrow |$  position.
2. Use the **MODE** button to select the capacitance measurement. The F (Farad) unit will be displayed.
3. Insert the black probe lead into the negative **COM** terminal and the red probe lead into the positive  $\overset{V_{mV\Omega}}{LoZ}$  terminal.
4. Touch the tips of the probe across the part under test.

5. Read the capacitance value on the display.

**Note:** For very large capacitance values, it may take several minutes for the measurement to settle and the final reading to stabilize.

## 5.9 Type K Temperature Measurements



1. Set the function to the  position.
2. Use the **MODE** button to select temperature measurement. The °F or °C unit will be displayed.
3. While observing the polarity, insert the thermocouple adapter into the negative **COM** terminal and the positive  $\overset{V\ mV\ \Omega}{LoZ}$  terminal.
4. Touch the tip of the thermocouple to the part under test. Keep the thermocouple tip on the part until the reading on the display stabilizes.
5. Read the temperature value on the display.
6. To avoid electrical shock, disconnect the thermocouple adapter before turning the function switch to another position.

## 5.10 Current Measurements

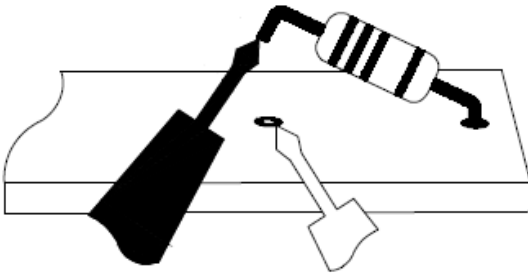
Current is measured by disconnecting the part under test and connecting the probe leads in series with the part, see Figure 5.1.



**Figure 5.1** Disconnected component

1. Set the function switch to the  $\approx$  position.
2. Insert the black probe lead into the negative **COM** terminal and the red probe lead into one of the following positive terminals:
  - **A** for high current measurements.
  - **mA** for low current measurements.
3. Use the **MODE** button to select AC, DC, or AC + DC voltage measurement.
  - The  indicator will be displayed for AC measurements.
  - The  indicator will be displayed for DC measurements.
  - The  indicator will be displayed for AC + DC measurements.
4. Connect the probe leads in series with the part in accordance with Figure 5.1.
5. Read the current value on the display.



## 5.11 Extended Functionality

In addition to the basic measurements, the meter can be set to different modes for extended functionality.

### 5.11.1 Selecting the Mode

The mode icons applicable for the selected measurement type are displayed in the lower part of the display. When a mode is enabled, the icon is framed.



**Figure 5.2** Mode icons (AC voltage measurements): Peak mode and Silent mode are enabled.

1. Press the ◀ or ▶ button to navigate to the desired mode icon. The currently selected icon will flash.
2. Press the button to enable the selected (flashing) mode.
3. Use the ▲ or ▼ buttons to step through the mode options. Refer to the section related to the specific mode for detailed instructions.
4. Press the button to disable the selected (flashing) mode.

### 5.11.2 VFD Mode (ACV and ACA only)

In VFD (variable-frequency drive) mode, high-frequency noise is eliminated from the voltage measurement through the use of a low-pass filter. VFD mode is available when measuring AC voltage or AC current.

1. Select and enable VFD mode as described in section 5.11.1 *Selecting the Mode*.

### 5.11.3 Peak Mode (ACV and ACA only)

In Peak mode, the meter captures and displays the positive and negative peak values, and updates only when a higher/lower value is registered.

1. Select and enable Peak mode as described section 5.11.1 *Selecting the Mode*.
2. Press the ▲ or ▼ button to toggle between the display of Peak Max and Peak Min.
  - In Peak Max mode, the ↑ indicator is displayed.
  - In Peak Min mode, the ↓ indicator is displayed.
1. Press the button to pause the Peak mode. Press again to continue.

### 5.11.4 Min/Max/Avg Mode

In Min/Max/Avg mode, the meter captures and displays the minimum or maximum values and updates only when a higher/lower value is registered. The meter also averages the total sum of all recorded values.

1. Select and enable Min/Max/Avg mode as described in section 5.11.1, *Selecting the Mode*.
2. Press the ▲ or ▼ button to cycle through the minimum, maximum, and average reading displays. The corresponding icons are displayed: ↓, ↑, or ◁
3. Press the button to pause the Min/Max/Avg mode. Press again to continue.

### 5.11.5 Frequency mode (ACV and ACA only)

In Frequency mode, the frequency is displayed in the main display and the period is displayed in the secondary display. Frequency mode is available when measuring AC voltage or current.

1. Select  and enable Frequency mode as described in section 5.11.1 *Selecting the mode*.

### 5.11.6 Relative mode

In Relative mode, the difference between the current reading and a stored reference value is displayed in the main display. The reference value is displayed in the secondary display.



1. Select  and enable Relative mode as described in section 5.11.1 *Selecting the mode*.

### 5.11.7 dBm Mode (ACV only)

The decibel (dB) is a logarithmic unit that expresses the magnitude of a physical quantity relative to a specified or implied reference level. In dBm mode, the meter displays AC voltage measurements in dB or dBm on the secondary display.









dB and dBm are defined as follows:

- $\text{dB} = 20 \log (V_{AC}/1)$ .
- $\text{dBm} = 20 \log (V_{AC}/0.7746)$ .

1. Select  and enable dBm mode as described in section 5.11.1, *Selecting the mode*.
2. Press the the  or  button to toggle between the display of dB and dBm.



### 5.11.8 Manual Data Recording Mode

The meter has 99 memory locations for the storage of measurement data.

1. Select  and enable Manual Data Recording mode as described in section 5.11.1 *Selecting the mode*.
2. Press the  or  button to cycle through the mode options: *SAVE*, *LOAD*, and *CLEAR* shown on the secondary display.
3. Press the  button to activate the displayed option:
  - *SAVE*: The data on the main display is saved to a memory location shown by the  indicator in the upper part of the display.
  - *LOAD*: The data stored in the memory location shown by the  indicator is displayed. Use the  or  button to change the memory location. Press the  button to exit the load function.
  - *CLEAR*: The data in all memory locations is erased.

### 5.11.9 Setup Mode

In Setup mode, you can define the settings for various meter options:

- Auto power off (indicated by the text *APO*): A mode where the time period after which the meter enters sleep mode can be set. The range is 1 to 30 minutes, or OFF. The factory default is 10 minutes.
  - Auto backlight off (indicated by the text *b.Lit*): A mode where the time period after which the backlight turns off can be set. The range is 1 to 30 minutes, or OFF. The factory default is 5 minutes.
  - Continuity threshold (indicated by the text *Cntin*): A mode where the threshold for continuity tests can be set.
  - Auto hold (indicated by the text *A.Hold*): Select Auto hold mode ON (Auto hold mode active) or OFF (Data hold mode active). For more information, see section 5.12 *Normal hold mode and Auto hold mode*.
1. Select  and enable Setup mode as described in section 5.11.1 *Selecting the mode*.
  2. Use the up/down arrows button to cycle through the mode options *APO*, *b.Lit*, *Cntin*, *A.Hold*, and *RESET* shown on the secondary display.
  3. Press the  button to activate the displayed option.
    - *APO*: Use the ◀ and ▶ buttons to change the auto power off time.
    - *b.Lit*: Use the ◀ and ▶ buttons to change the auto backlight off time.
    - *A.Hold*: Use the ◀ and ▶ buttons to configure auto hold/data hold. *On* indicates that the auto hold mode is active. *Off* indicates that the data hold mode is active.
    - *Cntin*: Use the ◀ and ▶ buttons to change the continuity threshold.
    - *RESET*: Press the  button to reset the settings to the factory default.

### 5.11.10 Silent Mode

In Silent mode, the alert beeper is disabled. Silent mode does not affect the continuity beeper.

Select  and enable Silent mode as described in section 5.11.1 *Selecting the mode*.

## 5.12 Normal Hold Mode and Auto Hold Mode

The meter has two types of hold modes: normal hold mode and auto hold mode.

### 5.12.1 Normal Hold Mode

In Normal hold mode, the meter freezes and displays the last reading from the main display and continues to display this value.

To enter/exit Normal hold mode, press the  button. In Hold mode, the  indicator is displayed.

### 5.12.2 Auto Hold Mode

In Auto hold mode, the secondary display freezes the last reading from the main display and continues to display this value. The current reading is displayed on the main display. The held reading (on the secondary display) will not change unless the difference between this held reading and any new reading is greater than 50 digits.



Auto hold limit:

- Function switch in **V** position: < 0.1 V
- Function switch in **LoZ** position: < 0.1 V
- Function switch in **mV** position: < 1 mV
- Function switch in other positions: no limit.

To enter/exit Auto hold mode, press the  button. In Auto hold mode, the  indicator is displayed and flashing.

## 5.13 Locked Mode

In Locked mode the meter ignores all button presses except . The auto power off function, see section 5.1.1 *Auto Power off*, is disabled in Locked mode.

Press and hold the  button for 3 seconds to enter/exit Locked mode. In Locked mode, the  indicator is displayed.

## 6. Maintenance

---

### 6.1 Cleaning and Storage

Clean the meter with a damp cloth and mild detergent; do not use abrasives or solvents.

If the meter is not to be used for an extended period, remove the batteries and store them separately.

### 6.2 Battery Replacement

The Battery symbol flashes with no 'bars' when the batteries have reached a critical level of 7.0V. The symbol stays active and visible while the LCD is powered.

The meter displays readings within specifications while the low battery indicator is on. When this is no longer possible, the display must be blanked. The meter powers off before it displays an out of tolerance voltage.

1. To avoid electrical shock, disconnect the meter if connected to a circuit, remove the probe from the terminals, and set the function switch to the OFF position before attempting to replace the batteries.
2. Unscrew and remove the battery compartment cover.
3. Replace the six standard AAA batteries, observing correct polarity.
4. Secure the battery compartment cover.

### 6.3 Fuse Replacement

The fuse accessed via the battery compartment cover. The fuse is rated 440mA/1000V, ceramic fast blow with a minimum Interrupt Rating of 10kA.

### 6.4 Disposal of Electronic Waste



As with most electronic products, this equipment must be disposed of in an environmentally friendly way, and in accordance with existing regulations for electronic waste. Please contact your FLIR Systems representative for more details.

## 7. Specifications

---

### 7.1 General specifications

Maximum voltage:	1000 V DC or 1000 V AC RMS.
Display Count:	4000 / 40 000.
Polarity Indication:	Automatic, positive implied, negative indicated.
Over-range Indication:	<i>OL</i>
Measuring Rate:	10 samples per second
Power Requirements:	6 x 1.5 V AAA alkaline batteries
Battery Life:	Approx. 100 hours with batteries (backlight and worklight off).
Low Battery Voltage:	Approx. 7.0 V.
Auto Power Off:	Default 10 minutes
Operating Temp/RH:	14°F to 86°F (-10°C to 30°C), < 85% RH. 86°F to 104°F (30°C to 40°C), < 75% RH. 104°F to 122°F (40°C to 50°C), <45% RH.
Storage Temperature/RH:	-22°F to 140°F (-30°C to -60°C), 0-80% RH (batteries not fitted).
Temperature Coefficient:	0.1 x (specified accuracy)/°C, < 64.4°F (18°C), >82.4°F (28°C).
Operating Altitude:	6560' (2000m).
Calibration Cycle:	Once per year.
Weight:	16.4 oz. (465g), including batteries.
Dimensions:	2.0 x 3.2 x 7.4 in (52 x 83 x 188mm), with holster.
Safety:	Complies with IEC 61010-1 CAT IV-600 V, CAT III-1000V, IEC 61010-2-033.

CAT	Application Field
I	Circuits not connected to mains.
II	Circuits directly connected to a low-voltage installation.
III	Building installation.
IV	Source of the low-voltage installation.

EMC: EN 61326-1.

Pollution degree: 2.

Drop protection: 6.6' (2m).

## 7.2 Electrical Range Specifications

**Table 7.1** Voltage. Resolution of specifications in the 3 ¼-digit mode.

Mode	Range	Accuracy							
DC	40.00 mV	0.05%+3d							
	400.0mV	0.05%+1d							
	4.000 V								
	40.00 V								
	400.0 V								
	1000 V								
		<b>40 Hz to 70 Hz</b>	<b>70 Hz to 1 kHz</b>	<b>1 kHz to 5 kHz</b>	<b>5 kHz to 20 kHz<sup>1</sup></b>				
AC	40.00 mV	0.5% + 2d	1.0% + 4d	2.0% + 4d	Unspecified				
	400.0mV	0.5% + 2d		1.0% + 4d		2.0% + 4d		2.0% + 20d	
	4.000 V								
	40.00 V								
	400.0 V	0.5% + 2d	1.0% + 4d	2.0% + 4d <sup>2</sup>	Unspecified				
	1000 V	0.5% + 2d	1.0% + 4d	Unspecified	Unspecified				

1. Below 10% or range, add 10d to accuracy.
2. Frequency range 1k to 2k Hz

Input protection: 1000 V DC or 1000 V AC RMS

Input impedance:

- mV: 1 MΩ, <100 pF.
- V: 10MΩ, < 100 pF.

Bandwidth: 40 Hz to 20kHz.

Minimum resolution: 1 μV in the 40 mV range.

CMRR/NMRR (common/normal mode rejection ratio):

- V AC: CMRR > 60 dB at DC, 50 Hz/60 Hz.
- V DC: CMRR > 100 dB at DC, 50 Hz/60 Hz.
- NMRR > 50 dB at DC, 50 Hz/60 Hz.

AC conversion type: AC coupled, true RMS responding, calibrated to the sine wave input.

For non-sine waves, add the following crest factor corrections:

- For a crest factor of 1.4-2.0, add 1.0% to the AC accuracy.
- For a crest factor of 2.0-2.5, add 2.5% to the AC accuracy.
- For a crest factor of 2.5-3.0, add 4.0% to the AC accuracy.

**Table 7.2** Current. Resolution of specifications in the 3 ½-digit mode.

Mode	Range	Accuracy		
DC	40.00 mA	0.2% + 1d		
	400.0mA			
	4.000 A			
	40.00 A	0.2% + 2d		
		<b>40 Hz to 70 Hz</b>	<b>70 Hz to 1 kHz</b>	<b>1 kHz to 10 kHz</b>
AC <sup>1</sup>	40.00 mA	1.0% + 2d	2.0% + 4d	2.0% + 4d <sup>2</sup>
	400.0mA			
	4.000 A	1.0% + 2d	2.0% + 4d	Unspecified
	10.00 A			

1. Below 5% of the AC range, add 20dgt to the accuracy.

2. Below 10% of range, add 10 dgt to accuracy.

Input protection: Equipped with a high-energy fuse.

- mA: 440 mA, 1000 V IR 10 kA fuse (Bussmann DMM-B-44/100).
- A: 11 A, 1000 V IR 20 kA fuse (Bussmann DMM-B-11A).

Input impedance:

- mA: 1Ω at mA input.
- A: 10 mΩ at A input.

Bandwidth: 40 Hz to 10 kHz.

Minimum resolution: 1 μA in the 40 mA range.

Maximum measuring time: 1 minute at A input, 10 minutes at mA input. Rest time is 20 minutes maximum.

AC conversion type: Same as for the voltage.



**Table 7.3** AC additional specifications

Mode	Range	Accuracy
AC + DC	Same as V and A	AC accuracy + 1.0%
VFD		AC accuracy for 40-400 Hz
Peak Hold		AC accuracy + (3.0% + 100 dgt) for 40Hz to 1 kHz.
Low-Z	Same as V	Accuracy + 1.0%

The cut-off frequency of VFD: 800 Hz (-3 dB point).

Attenuation characteristic of VFD: Approx. -24 dB.

**Table 7.4** Frequency Counter

Range	Resolution	Accuracy
400.00 Hz	0.01 Hz	± 5 dgt
4.0000 kHz	0.1 Hz	
40.000 kHz	1 Hz	
100.00 kHz	10 Hz	

Minimum sensed frequency: 5 Hz.

**Table 7.5** Frequency counter sensitivity

Function	Range	Sensitivity (peak to peak) 5 Hz to 10 kHz	Sensitivity (peak to peak) 10-100 kHz
mV	40.000 mV	10 mV	10 mV
	400.00 mV	100 mV	100 mV
V	4.0000 V	1 V	1 V
	40.000 V	10 V	10 V
	400.00 V	100 V	100 V
	1000 V	600 V	Unspecified
mA	40.000 mA	10 mA	Unspecified
	400.00 mA	100 mA	
A	4.0000 A	1 A	Unspecified
	10.000 A	6 A	

**Table 7.6** Resistance. Resolution of specifications in the 3 ¼-digit mode.

Range	Resolution	Accuracy
400.0 $\Omega$	100 m $\Omega$	$\pm (0.2\% + 2 \text{ dgt})$
4.000 k $\Omega$	1 $\Omega$	$\pm (0.2\% + 1 \text{ dgt})$
40.00 k $\Omega$	10 $\Omega$	
400.0 k $\Omega$	100 $\Omega$	
4.000 M $\Omega$	1k $\Omega$	$\pm (1.0\% + 1 \text{ dgt})$
40.00 M $\Omega$	10 k $\Omega$	$\pm (2.0\% + 20 \text{ dgt})$

Input protection: 1000 V DC or 1000 V AC RMS.

Maximum open circuit voltage: Approx. 2.5 V.

Maximum short test current: Approx. 0.1 mA.

**Table 7.7** Continuity check. Resolution of specifications in the 3 ¼-digit mode

Range	Resolution	Accuracy
400.0 $\Omega$	100 m $\Omega$	$\pm (0.2\% + 2 \text{ dgt})$

Input protection: 1000 V DC or 1000 V AC RMS.

Maximum open circuit voltage: Approx. 2.5 V.

Maximum short test current: Approx. 1 mA.

Continuity threshold: Default < 30  $\Omega$ .

Continuity response time: 10 ms for < 10  $\Omega$ , 200 ms for > 10  $\Omega$ .

Continuity indicator: 2 kHz tone buzzer.

**Table 7.8** Diode Test

Range	Resolution	Accuracy
2.000	1 mV	$\pm (1.5\% + 2 \text{ dgt})$

Input protection: 1000 V DC or 1000 V AC RMS.

Maximum open circuit voltage: Approx.  $\pm 2.5$  V.

Maximum short test current: Approx.  $\pm 1$  mA.

**Table 7.9** Capacitance

Range	Resolution	Accuracy
40.00 nF	10 pF	± (1.2% + 20 dgt)
400.0 nF	100 pF	± (0.9% + 10 dgt)
4.000 μF	1 nF	± (0.9% + 5 dgt)
40.00 μF	10 nF	± (0.9% + 2 dgt)
400.0 μF	100 nF	± (0.9% + 2 dgt)
4.000 mF	1 μF	± (1.2% + 20 dgt)
40.00 mF	10μF	± (2.0% + 20 dgt)

Input protection: 1000 V DC or 1000 V AC RMS.

**Table 7.10** Temperature

Range	Resolution	Accuracy
-328°F to 2192°F	0.1 °F	1.0% + 36 dgt
-200°C to 1200°C	0.1 °C	1.0% + 20 dgt

**Note:** Accuracy specification assumes the ambient temperature is stable to ± 1.8°F (± 1°C). For ambient temperature changes of ± 9°F (± 5°C), the rated accuracy applies after 1 hour.

## 8. Technical Support

---

<b>Main Website</b>	<a href="http://www.flir.com/test">http://www.flir.com/test</a>
<b>Technical Support Website</b>	<a href="http://support.flir.com">http://support.flir.com</a>
<b>Technical support Email</b>	T&MSupport@flir.com
<b>Service/Repair Support Email</b>	Repair@flir.com
<b>Support Telephone number</b>	+1 855-499-3662 (toll-free)

## 9. Warranties

---

### 9.1 FLIR Global Limited Lifetime Warranty

A qualifying FLIR Test and Measurement product (the "Product") purchased either directly from FLIR Commercial Systems Inc and affiliates (FLIR) or from an authorized FLIR distributor or reseller that Purchaser registers on-line with FLIR is eligible for coverage under FLIR's Limited Lifetime Warranty, subject to the terms and conditions in this document. This warranty only applies to purchases of Qualifying Products (see below) purchased and manufactured after April 1, 2013.

PLEASE READ THIS DOCUMENT CAREFULLY; IT CONTAINS IMPORTANT INFORMATION ABOUT THE PRODUCTS THAT QUALIFY FOR COVERAGE UNDER THE LIMITED LIFETIME WARRANTY, PURCHASER'S OBLIGATIONS, HOW TO ACTIVATE THE WARRANTY, WARRANTY COVERAGE, AND OTHER IMPORTANT TERMS, CONDITIONS, EXCLUSIONS AND DISCLAIMERS.

1. **PRODUCT REGISTRATION.** To qualify for FLIR's Limited Lifetime Warranty, Purchaser must fully register the Product directly with FLIR on-line at <http://www.flir.com> within Sixty (60) DAYS of the date the Product was purchased by the first retail customer (the "Purchase Date"). Qualifying PRODUCTS THAT ARE NOT REGISTERED ON-LINE WITHIN SIXTY (60) DAYS OF THE PURCHASE DATE WILL HAVE A LIMITED ONE YEAR WARRANTY FROM DATE OF PURCHASE.

2. **QUALIFYING PRODUCTS.** Upon registration, Test and Measurement products that qualify for coverage under FLIR's Limited Lifetime Warranty are: MR7x, CM7x, CM8x, DM9x, IM7x and VP5x not including accessories which may have their own warranty.

3. **WARRANTY PERIODS.** For purposes of the The Limited Lifetime Warranty, Lifetime is defined as seven years (7) after the product is no longer manufactured, or ten years (10) from date of purchase, whichever is greater. This Warranty is only applicable to the original owner of the Products.

Any Product that is repaired or replaced under warranty is covered under this Limited Lifetime Warranty for one hundred eighty days (180) days from the date of return shipment by FLIR or for the remaining duration of the applicable Warranty Period, whichever is longer.

4. **LIMITED WARRANTY.** In accordance with the terms and conditions of this Limited Lifetime Warranty, and except as excluded or disclaimed in this document, FLIR warrants, from the Purchase Date, that all fully registered Products will conform to FLIR's published Product specifications and be free from defects in materials and workmanship during the applicable Warranty Period. PURCHASER'S SOLE AND EXCLUSIVE REMEDY UNDER THIS WARRANTY, AT FLIR'S SOLE DISCRETION, IS THE REPAIR OR REPLACEMENT OF DEFECTIVE PRODUCTS IN A MANNER, AND BY A SERVICE CENTER, AUTHORIZED BY FLIR. IF THIS REMEDY IS ADJUDICATED TO BE INSUFFICIENT, FLIR SHALL REFUND PURCHASER'S PAID PURCHASE PRICE AND HAVE NO OTHER OBLIGATION OR LIABILITY TO BUYER WHATSOEVER.

5. **WARRANTY EXCLUSIONS AND DISCLAIMERS.** FLIR MAKES NO OTHER WARRANTY OF ANY KIND WITH RESPECT TO THE PRODUCTS. ALL OTHER WARRANTIES, EXPRESS OR IMPLIED, INCLUDING BUT NOT LIMITED TO IMPLIED WARRANTIES OF MERCHANTABILITY, FITNESS FOR A PARTICULAR PURPOSE (EVEN IF PURCHASER HAS NOTIFIED FLIR OF ITS INTENDED USE FOR THE PRODUCTS), AND NON-INFRINGEMENT ARE EXPRESSLY EXCLUDED FROM THIS AGREEMENT.

THIS WARRANTY EXPRESSLY EXCLUDES ROUTINE PRODUCT MAINTENANCE, SOFTWARE UPDATES, AND REPLACEMENT OF FLIR DM92 USER GUIDE

MANUALS, FUSES, OR DISPOSABLE BATTERIES. FLIR FURTHER EXPRESSLY DISCLAIMS ANY WARRANTY COVERAGE WHERE THE ALLEGED NONCONFORMITY IS DUE TO NORMAL WEAR AND TEAR, OTHER ALTERATION, MODIFICATION, REPAIR, ATTEMPTED REPAIR, IMPROPER USE, IMPROPER MAINTENANCE, NEGLIGENCE, ABUSE, IMPROPER STORAGE, FAILURE TO FOLLOW ANY PRODUCT INSTRUCTIONS, DAMAGE (WHETHER CAUSED BY ACCIDENT OR OTHERWISE), OR ANY OTHER IMPROPER CARE OR HANDLING OF THE PRODUCTS CAUSED BY ANYONE OTHER THAN FLIR OR FLIR'S EXPRESSLY AUTHORIZED DESIGNEE.

THIS DOCUMENT CONTAINS THE ENTIRE WARRANTY AGREEMENT BETWEEN PURCHASER AND FLIR AND SUPERSEDES ALL PRIOR WARRANTY NEGOTIATIONS, AGREEMENTS, PROMISES AND UNDERSTANDINGS BETWEEN PURCHASER AND FLIR. THIS WARRANTY MAY NOT BE ALTERED WITHOUT THE EXPRESS WRITTEN CONSENT OF FLIR.

6. WARRANTY RETURN, REPAIR AND REPLACEMENT. To be eligible for warranty repair or replacement, Purchaser must notify FLIR within thirty (30) days of discovering of any apparent defect in materials or workmanship. Before Purchaser may return a Product for warranty service or repair, Purchaser must first obtain a returned material authorization (RMA) number from FLIR. To obtain the RMA number Owner must provide an original proof of purchase. For additional information, to notify FLIR of an apparent defect in materials or workmanship, or to request an RMA number, visit <http://www.flir.com>. Purchaser is solely responsible for complying with all RMA instructions provided by FLIR including but not limited to adequately packaging the Product for shipment to FLIR and for all packaging and shipping costs. FLIR will pay for returning to Purchaser any Product that FLIR repairs or replaces under warranty.

FLIR reserves the right to determine, in its sole discretion, whether a returned Product is covered under Warranty. If FLIR determines that any returned Product is not covered under Warranty or is otherwise excluded from Warranty coverage, FLIR may charge Purchaser a reasonable handling fee and return the Product to Purchaser, at Purchaser's expense, or offer Purchaser the option of handling the Product as a non-warranty return.

7. NON-WARRANTY RETURN. Purchaser may request that FLIR evaluate and service or repair a Product not covered under warranty, which FLIR may agree to do in its sole discretion. Before Purchaser returns a Product for non-warranty evaluation and repair, Purchaser must contact FLIR by visiting <http://www.flir.com> to request an evaluation and obtain an RMA. Purchaser is solely responsible for complying with all RMA instructions provided by FLIR including but not limited to adequately packaging the Product for shipment to FLIR and for all packaging and shipping costs. Upon receipt of an authorized non-warranty return, FLIR will evaluate the Product and contact Purchaser regarding the feasibility of and the costs and fees associated with Purchaser's request. Purchaser is responsible for the reasonable cost of FLIR's evaluation, for the cost of any repairs or services authorized by Purchaser, and for the cost of repackaging and returning the Product to Purchaser.

Any non-warranty repair of a Product is warranted for one hundred eighty days (180) days from the date of return shipment by FLIR to be free from defects in materials and workmanship only, subject to all of the limitations, exclusions and disclaimers in this document.

## 9.2 FLIR Test and Measurement Limited 2 Year Warranty

A qualifying FLIR Test and Measurement product (the "Product") purchased either directly from FLIR Commercial Systems Inc and affiliates (FLIR) or from an authorized FLIR distributor or reseller that Purchaser registers on-line with FLIR is eligible for coverage under FLIR's Limited Warranty, subject to the terms and conditions in this document. This warranty only applies to purchases of Qualifying Products (see below) purchased and manufactured after April 1, 2013.

PLEASE READ THIS DOCUMENT CAREFULLY; IT CONTAINS IMPORTANT INFORMATION ABOUT THE PRODUCTS THAT QUALIFY FOR COVERAGE UNDER THE LIMITED WARRANTY, PURCHASER'S OBLIGATIONS, HOW TO ACTIVATE THE WARRANTY, WARRANTY COVERAGE, AND OTHER IMPORTANT TERMS, CONDITIONS, EXCLUSIONS AND DISCLAIMERS.

1. PRODUCT REGISTRATION. To qualify for FLIR's Limited Warranty, Purchaser must fully register the Product directly with FLIR on-line at <http://www.flir.com> within Sixty (60) DAYS of the date the Product was purchased by the first retail customer (the "Purchase Date"). Qualifying PRODUCTS THAT ARE NOT REGISTERED ON-LINE WITHIN SIXTY (60) DAYS OF THE PURCHASE DATE WILL HAVE A LIMITED ONE YEAR WARRANTY FROM DATE OF PURCHASE.

2. QUALIFYING PRODUCTS. Upon registration, Test and Measurement products that qualify for coverage under FLIR's Limited Warranty are: VS70 Videoscope, VSAXx Articulation Camera, VSCxx Camera, VSSxx Probe Spool, VST handset, MR02 Pin Extension Probe, and TAxX not including accessories which may have their own warranty.

3. WARRANTY PERIODS. The applicable Limited Warranty Period measured from the Purchase data are:

Products	Limited Warranty Period
VS70, VSAXx, VSCxx, VSSxx, VST, MR02, TAxX	TWO (2) Years

Any Product that is repaired or replaced under warranty is covered under this Limited Warranty for one hundred eighty days (180) days from the date of return shipment by FLIR or for the remaining duration of the applicable Warranty Period, whichever is longer.

4. LIMITED WARRANTY. In accordance with the terms and conditions of this Limited Warranty, and except as excluded or disclaimed in this document, FLIR warrants, from the Purchase Date, that all fully registered Products will conform to FLIR's published product specifications and be free from defects in materials and workmanship during the applicable Warranty Period. PURCHASER'S SOLE AND EXCLUSIVE REMEDY UNDER THIS WARRANTY, AT FLIR'S SOLE DISCRETION, IS THE REPAIR OR REPLACEMENT OF DEFECTIVE PRODUCTS IN A MANNER, AND BY A SERVICE CENTER, AUTHORIZED BY FLIR. IF THIS REMEDY IS ADJUDICATED TO BE INSUFFICIENT, FLIR SHALL REFUND PURCHASER'S PAID PURCHASE PRICE AND HAVE NO OTHER OBLIGATION OR LIABILITY TO BUYER WHATSOEVER.

5. WARRANTY EXCLUSIONS AND DISCLAIMERS. FLIR MAKES NO OTHER WARRANTY OF ANY KIND WITH RESPECT TO THE PRODUCTS. ALL OTHER WARRANTIES, EXPRESS OR IMPLIED, INCLUDING BUT NOT LIMITED TO IMPLIED WARRANTIES OF MERCHANTABILITY, FITNESS FOR A PARTICULAR PURPOSE (EVEN IF PURCHASER HAS NOTIFIED FLIR OF ITS INTENDED USE FOR THE PRODUCTS), AND NON-INFRINGEMENT ARE EXPRESSLY EXCLUDED FROM THIS AGREEMENT.

THIS WARRANTY EXPRESSLY EXCLUDES ROUTINE PRODUCT MAINTENANCE, SOFTWARE UPDATES, AND REPLACEMENT OF FUSES, OR DISPOSABLE BATTERIES. FLIR FURTHER EXPRESSLY DISCLAIMS ANY WARRANTY COVERAGE WHERE THE ALLEGED NONCONFORMITY IS DUE TO NORMAL WEAR AND TEAR, OTHER ALTERATION, MODIFICATION, REPAIR, ATTEMPTED REPAIR, IMPROPER USE, IMPROPER MAINTENANCE, NEGLIGENCE, ABUSE, IMPROPER STORAGE, FAILURE TO FOLLOW ANY PRODUCT INSTRUCTIONS, DAMAGE (WHETHER CAUSED BY ACCIDENT OR OTHERWISE), OR ANY OTHER IMPROPER CARE OR HANDLING OF THE PRODUCTS CAUSED BY ANYONE OTHER THAN FLIR OR FLIR'S EXPRESSLY AUTHORIZED DESIGNEE.

THIS DOCUMENT CONTAINS THE ENTIRE WARRANTY AGREEMENT BETWEEN PURCHASER AND FLIR AND SUPERSEDES ALL PRIOR WARRANTY NEGOTIATIONS, AGREEMENTS, PROMISES AND UNDERSTANDINGS BETWEEN PURCHASER AND FLIR. THIS WARRANTY MAY NOT BE ALTERED WITHOUT THE EXPRESS WRITTEN CONSENT OF FLIR.

6. WARRANTY RETURN, REPAIR AND REPLACEMENT. To be eligible for warranty repair or replacement, Purchaser must notify FLIR within thirty (30) days of discovering of any apparent defect in materials or workmanship. Before Purchaser may return a Product for warranty service or repair, Purchaser must first obtain a returned material authorization (RMA) number from FLIR. To obtain the RMA number Owner must provide an original proof of purchase. For additional information, to notify FLIR of an apparent defect in materials or workmanship, or to request an RMA number, visit <http://www.flir.com>. Purchaser is solely responsible for complying with all RMA instructions provided by FLIR including but not limited to adequately packaging the Product for shipment to FLIR and for all packaging and shipping costs. FLIR will pay for returning to Purchaser any Product that FLIR repairs or replaces under warranty.

FLIR reserves the right to determine, in its sole discretion, whether a returned Product is covered under Warranty. If FLIR determines that any returned Product is not covered under Warranty or is otherwise excluded from Warranty coverage, FLIR may charge Purchaser a reasonable handling fee and return the Product to Purchaser, at Purchaser's expense, or offer Purchaser the option of handling the Product as a non-warranty return.

7. NON-WARRANTY RETURN. Purchaser may request that FLIR evaluate and service or repair a Product not covered under warranty, which FLIR may agree to do in its sole discretion. Before Purchaser returns a Product for non-warranty evaluation and repair, Purchaser must contact FLIR by visiting <http://www.flir.com> to request an evaluation and obtain an RMA. Purchaser is solely responsible for complying with all RMA instructions provided by FLIR including but not limited to adequately packaging the Product for shipment to FLIR and for all packaging and shipping costs. Upon receipt of an authorized non-warranty return, FLIR will evaluate the Product and contact Purchaser regarding the feasibility of and the costs and fees associated with Purchaser's request. Purchaser is responsible for the reasonable cost of FLIR's evaluation, for the cost of any repairs or services authorized by Purchaser, and for the cost of repackaging and returning the Product to Purchaser.

Any non-warranty repair of a Product is warranted for one hundred eighty days (180) days from the date of return shipment by FLIR to be free from defects in materials and workmanship only, subject to all of the limitations, exclusions and disclaimers in this document.



---

## Corporate Headquarters

FLIR Systems, Inc.  
2770 SW Parkway Avenue  
Wilsonville, OR 97070  
USA  
Telephone: +1 503-498-3547

## Customer Support

Technical Support Website	<a href="http://support.flir.com">http://support.flir.com</a>
Technical Support Email	<a href="mailto:T&amp;MSupport@flir.com">T&amp;MSupport@flir.com</a>
Service and Repair Email	<a href="mailto:Repair@flir.com">Repair@flir.com</a>
Customer Support Telephone	+1 855-499-3662 (toll free)

Publication Identification No.:	DM92-en-US
Release Version:	AB
Release Date:	2014 November
Language:	en-US