

EVALUATION KIT
AVAILABLE

1575MHz GPS Front-End Amplifier

MAX12000

General Description

The MAX12000 GPS front-end amplifier IC is designed for automotive and marine GPS satellite navigation antenna modules or for any application that needs to compensate for cable losses from the GPS antenna to receiver. Two unconditionally stable low-noise amplifier stages provide the high gain and integrated I/O matching to minimize the need for external matching components and eliminate the need for additional gain stages. The MAX12000 features the option to place a bandpass ceramic or SAW filter between the two amplifier stages to provide a narrow-band output to further improve the noise performance of the GPS receiver. Additionally, a 3.4dB gain step is provided to compensate for cable loss variation between different applications.

The MAX12000 is designed to operate at the GPS frequency of 1575MHz with a 34.8dB typical cascaded gain and a 25mA supply current. The two LNA stages allow the use of a wide range of GPS filter types for maximum flexibility in system design. The final RF output pin, which drives the cable to the GPS receiver, is also the power-supply connection that accepts a DC supply in the +3.0V to +5.5V range. Alternatively, the DC supply can be applied to pin 4.

The GPS front-end amplifier is designed on a low-noise, advanced SiGe process and is available in a lead-free, 10-pin TDFN surface-mount package (3mm x 3mm).

Applications

Integrated Automotive and Marine GPS Receivers

Features

- ◆ First Amp Noise Figure*: 1.0dB
- ◆ High Gain**: 34.8dB
- ◆ 3.4dB Gain Step
- ◆ Integrated 50Ω Output Matching
- ◆ 3.0V to 5.5V Supply Voltage Range
- ◆ Small, Low-Cost Package (3mm x 3mm)
- ◆ ESD Protected to ±1kV Human Body Model

*Without external input impedance match.

**First amplifier input is impedance matched ($S_{11} = -10\text{dB}$).

Second amplifier set to high gain. Amplifiers cascaded without interstage filter.

Ordering Information

PART	TEMP RANGE	PIN-PACKAGE	PKG CODE
MAX12000ETB+	-40°C to +85°C	10 TDFN	T1033-2

+Denotes lead-free package.

Typical Operating Circuit appears at end of data sheet.

Pin Configuration/Functional Diagram

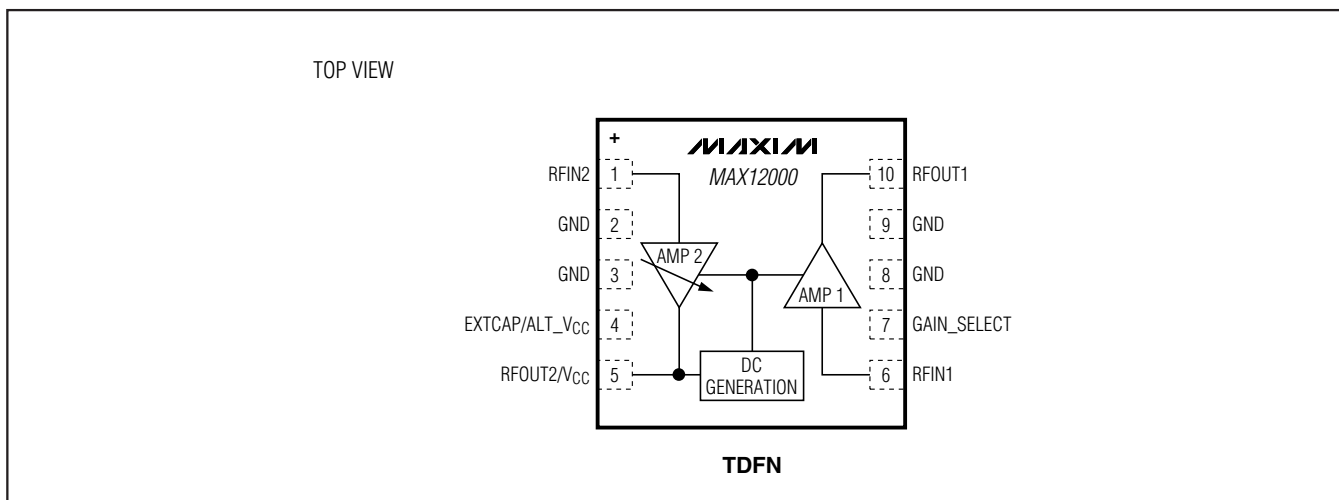

1575MHz GPS Front-End Amplifier

ABSOLUTE MAXIMUM RATINGS

RFOUT1, RFOUT2, EXTCAP to GND.....-0.3V to (V_{CC} + 0.5V)
 RFIN1 Input Power (50Ω source)+15dBm
 RFIN1 to GND.....-0.3V to +0.3V
 RFIN2 to GND.....-0.3V to +1.0V
 GAIN_SELECT to GND.....-0.3V to (V_{CC} + 0.3V)

Continuous Power Dissipation (T_A = +70°C)
 10-Pin TDFN (derate 18.5mW/°C above +70°C)1481mW
 Operating Ambient Temperature Range-40°C to +105°C
 Maximum Junction Temperature+150°C
 Storage Temperature Range-65°C to +150°C
 Lead Temperature (soldering, 10s)+300°C

Stresses beyond those listed under "Absolute Maximum Ratings" may cause permanent damage to the device. These are stress ratings only, and functional operation of the device at these or any other conditions beyond those indicated in the operational sections of the specifications is not implied. Exposure to absolute maximum rating conditions for extended periods may affect device reliability.



CAUTION! ESD SENSITIVE DEVICE

DC ELECTRICAL CHARACTERISTICS

(V_{CC} = +3.0V to +5.5V, T_A = -40°C to +85°C. Typical values are at +5.0V and at T_A = +25°C. Pin 7 open, unless otherwise noted.) (Note 1)

PARAMETER	SYMBOL	CONDITIONS	MIN	TYP	MAX	UNITS
Supply Voltage	V _{CC}		3.0		5.5	V
Supply Current	I _{CC}	T _A = +25°C	15.0	25	30.2	mA
		T _A = -40°C to 105°C (Note 2)			33	
Gain-Select Input Current	I _{IL}	V _{IL} = 0V		20	100	μA

AC ELECTRICAL CHARACTERISTICS

(V_{CC} = +3.0V to +5.5V, P_{IN} = -40dBm, f_{IN} = 1575MHz, T_A = -40°C to +85°C. Typical values are at +5.0V and at T_A = +25°C. Input matched to 50Ω, load = 50Ω, pin 7 open, unless otherwise noted.) (Note 1)

PARAMETER	SYMBOL	CONDITIONS	MIN	TYP	MAX	UNITS
Operation Frequency	f _{RF}			1575		MHz
AMP 1 Gain	S ₂₁	50Ω source with no input match (Note 3)	15.0	16.7	18.5	dB
		50Ω source with input match		17.8		
AMP 1 Gain Variation Over Temperature				0.3		dB
AMP 1 Noise Figure	NF	No input match (Notes 3, 4)		1	1.3	dB
AMP 1 Input Third-Order Intercept Point	IIP3	Two tones at 1574.5MHz and 1575.5MHz, -35dBm per tone		-12		dBm
AMP 1 Input 1dB Compression Point		50Ω source with no input match (Note 3)		-19		dBm
AMP 1 Input Return Loss	S ₁₁	No input match (Note 3)		-4.4		dB
AMP 1 Output Return Loss	S ₂₂			-14.5		dB
AMP 1 Reverse Isolation	S ₁₂			-33		dB
AMP 2 Gain	S ₂₁		15.0	17	19.6	dB
AMP 2 Gain Step		Gain change when pin 7 is shorted to GND	-2.8	-3.4	-4.0	dB
AMP 2 Gain Variation Over Temperature				1		dB
AMP 2 Noise Figure	NF	(Note 4)		2.0	2.4	dB
AMP 2 Output Third-Order Intercept Point	OIP3	Two tones at 1574.5MHz and 1575.5MHz, -30dBm per tone		16.0		dBm
AMP 2 Output 1dB Compression Point			1.5	5.3		dBm

1575MHz GPS Front-End Amplifier

AC ELECTRICAL CHARACTERISTICS (continued)

($V_{CC} = +3.0V$ to $+5.5V$, $P_{IN} = -40dBm$, $f_{IN} = 1575MHz$, $T_A = -40^{\circ}C$ to $+85^{\circ}C$. Typical values are at $+5.0V$ and at $T_A = +25^{\circ}C$. Input matched to 50Ω , load = 50Ω , pin 7 open, unless otherwise noted.) (Note 1)

PARAMETER	SYMBOL	CONDITIONS	MIN	TYP	MAX	UNITS
AMP 2 Input Return Loss	$ S_{11} $			-21		dB
AMP 2 Output Return Loss	$ S_{22} $			-8.8		dB
AMP 2 Reverse Isolation	$ S_{12} $			-25		dB

Note 1: At $T_A = -40^{\circ}C$, the minimum and maximum values are guaranteed by design and characterization, unless otherwise noted.

Note 2: At $T_A = -40^{\circ}C$ and $+105^{\circ}C$, the maximum value is guaranteed by design and characterization.

Note 3: Measured using MAX12000 evaluation board with a DC-blocking capacitor at the input of LNA 1.

Note 4: At $T_A = +25^{\circ}C$, the maximum value is guaranteed by design and characterization. Specification is corrected for board losses on the MAX12000 EV kit.

Typical Operating Characteristics

($P_{IN} = -40dBm$, $f_{IN} = 1575MHz$, inputs and outputs are terminated to 50Ω , $V_{CC} = +5.0V$, $T_A = +25^{\circ}C$, unless otherwise noted.)

**AMP 1 NOISE FIGURE vs. TEMPERATURE
(WITHOUT EXTERNAL INPUT IMPEDANCE MATCH)**

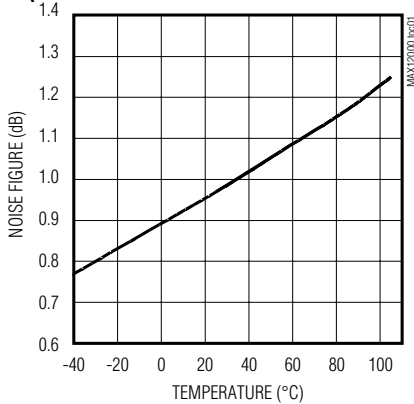

AMP 2 NOISE FIGURE vs. TEMPERATURE

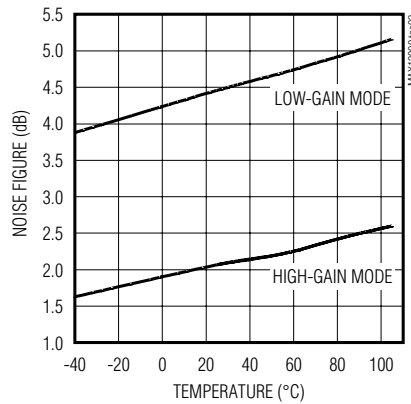

**SUPPLY VOLTAGE vs. CURRENT
(PIN 7 OPEN)**

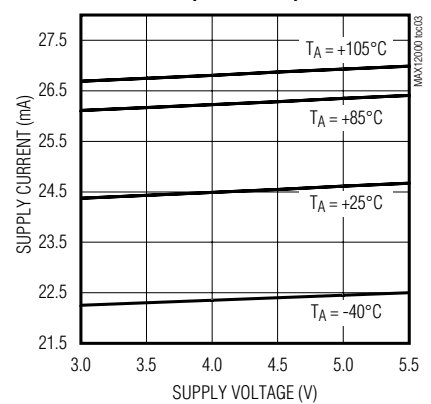

**AMP 1 GAIN vs. SUPPLY VOLTAGE
(WITH EXTERNAL INPUT IMPEDANCE MATCH)**

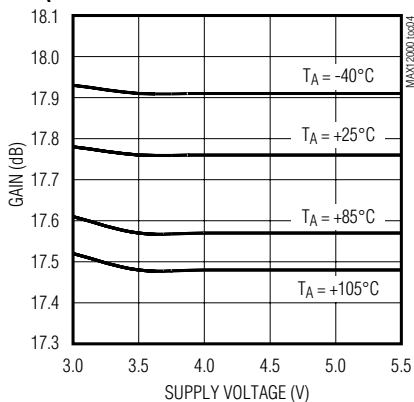

**AMP 2 GAIN vs. SUPPLY VOLTAGE
(PIN 7 OPEN)**

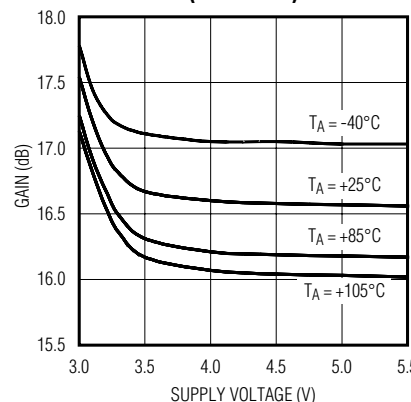

**AMP 2 GAIN vs. SUPPLY VOLTAGE
(PIN 7 SHORT TO GND)**

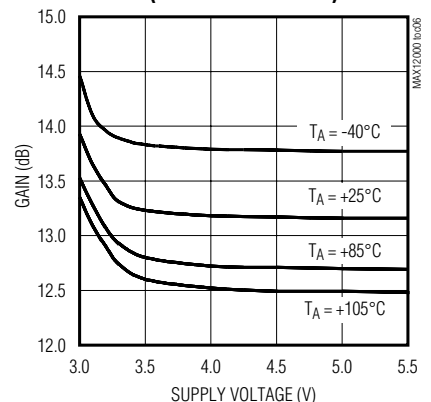

1575MHz GPS Front-End Amplifier

Typical Operating Characteristics (continued)

($P_{IN} = -40\text{dBm}$, $f_{IN} = 1575\text{MHz}$, inputs and outputs are terminated to 50Ω , $V_{CC} = +5.0\text{V}$, $T_A = +25^\circ\text{C}$, unless otherwise noted.)

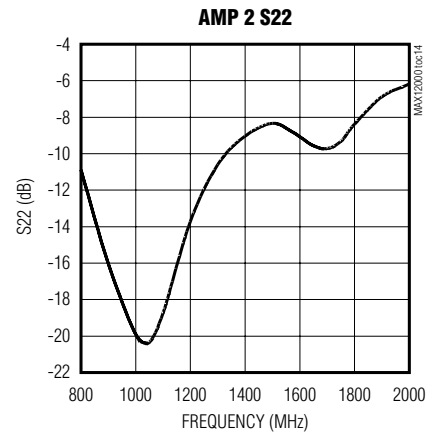
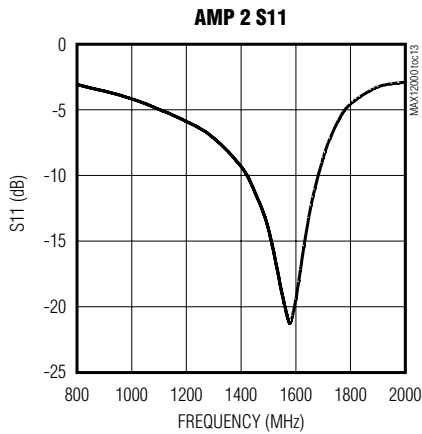
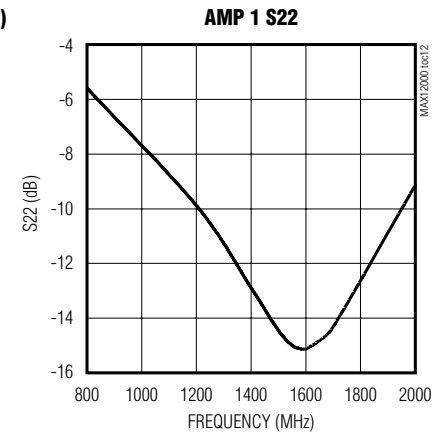
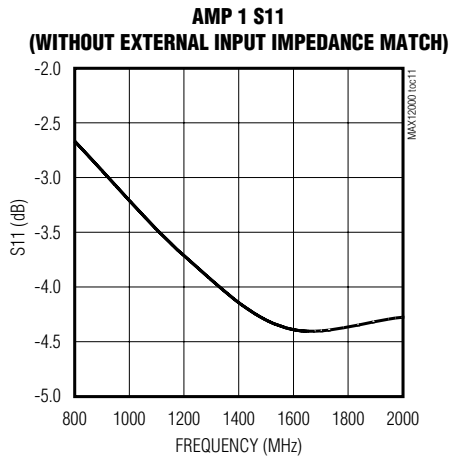
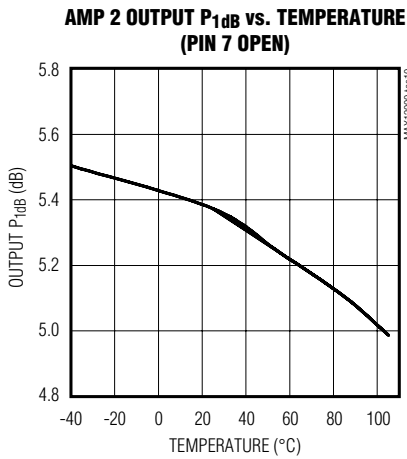
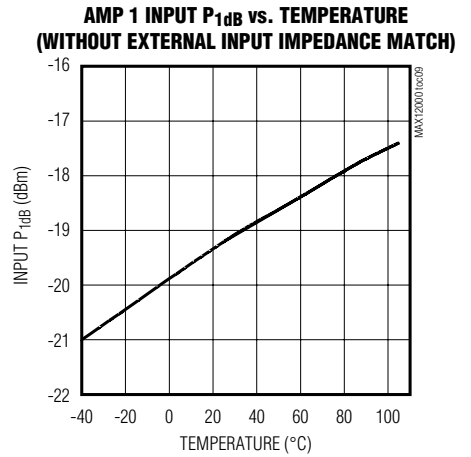
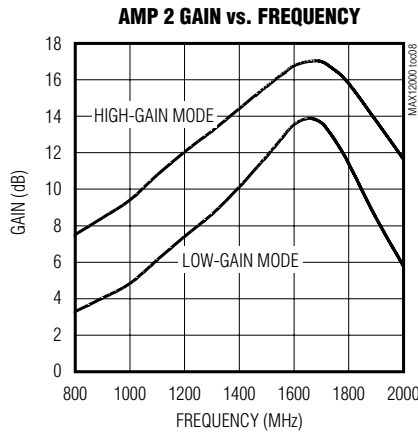
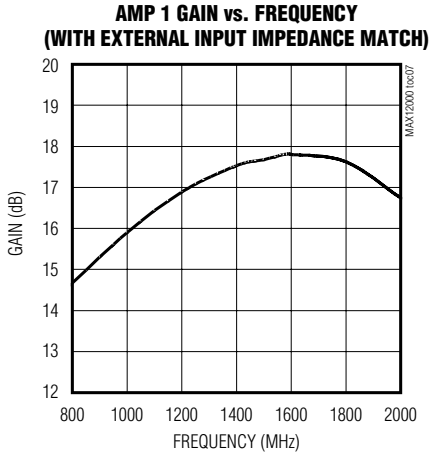

1575MHz GPS Front-End Amplifier

MAX12000

Typical Operating Characteristics (continued)

($P_{IN} = -40\text{dBm}$, $f_{IN} = 1575\text{MHz}$, inputs and outputs are terminated to 50Ω , $V_{CC} = +5.0\text{V}$, $T_A = +25^\circ\text{C}$, unless otherwise noted.)

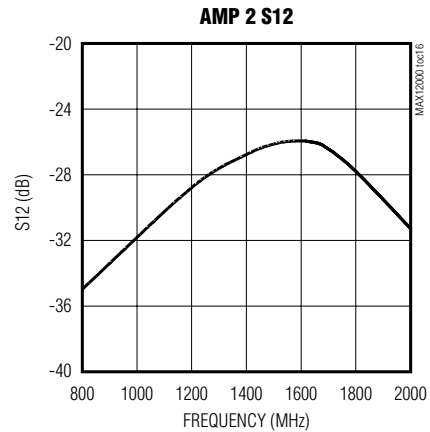
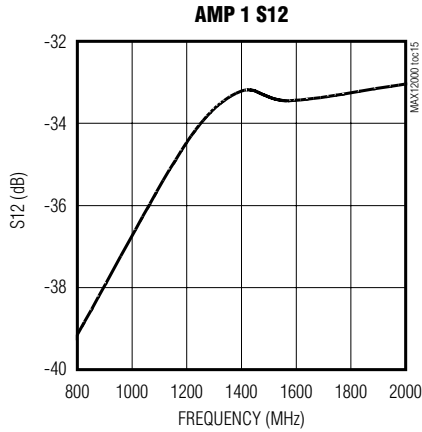

Pin Description

PIN	NAME	FUNCTION
1	RFIN2	Amplifier 2 Input. Incorporates an internal DC-blocking capacitor and is internally matched to 50Ω . This input is designed to be connected to a bandpass filter.
2, 3, 8, 9	GND	Electrical Ground
4	EXTCAP/ ALT_VCC	External Smoothing Capacitor for Internal Supply Voltage or Can Be Used as the External DC Supply Pin to Eliminate the Need for a Bias-T on Pin 5
5	RFOUT2/VCC	Amplifier 2 Output. Incorporates an internal DC-blocking capacitor and is internally matched to 50Ω . DC bias on this pin serves as the power supply through a bias-T.
6	RFIN1	Amplifier 1 Input. Requires external DC-blocking capacitor and matching components.
7	GAIN_SELECT	AMP 2 Gain Select. Open is high-gain mode. Short to ground is low-gain mode.
10	RFOUT1	Amplifier 1 Output. Incorporates an internal DC-blocking capacitor and is internally matched to 50Ω . This output is designed to drive a bandpass filter.
EP	Exposed Pad	Ground. The exposed pad must be soldered to the circuit board for proper thermal and electrical performance.

1575MHz GPS Front-End Amplifier

Detailed Description

The MAX12000 IC contains two LNA stages tuned for use at 1575MHz.

AMP 1

AMP 1 has an internal load that limits the bandwidth and provides a 50Ω output impedance through a DC-blocking capacitor. The internal biasing for AMP 1 suppresses gain variation with changes in temperature and supply voltage. At the input, an integrated DC-blocking capacitor and matching network are intentionally omitted to allow selection of external components to optimize for noise or gain.

AMP 2 with Gain Step

The output of AMP 2 has the dual role of providing both the RF output drive and receiving the DC power supply through a single cable. Both the input and output ports of AMP 2 are internally matched to 50Ω impedance at 1575MHz. A 3.4dB gain switch can be used to adjust the gain for different applications. The gain-select pin is connected to an inverter with an internal pullup resistor. Hence, the gain-select pin is set by default to high-gain mode. Shorting the gain-select pin to ground sets the gain stage to a 3.4dB lower gain. As with AMP 1, AMP 2 has an internal load that limits the bandwidth, and the amplifier's internal biasing suppresses gain variation with changes in temperature and supply voltage.

Supply

The IC power can be supplied from the navigation system through the RF cable (pin 5). An integrated filter circuit is connected to the output of LNA 2 to separate the supply voltage from the GPS signal. Alternatively, the supply voltage can be applied to the external capacitor pin (pin 4).

Layout Considerations

For best performance, carefully lay out the printed circuit board using high-frequency techniques. Use controlled-impedance transmission lines to interface with the MAX12000 high-speed inputs and outputs and isolate the input signals from the output signals as much as possible. For improved noise figure, keep the connection to the input of LNA 1 as short as possible. A power-supply decoupling capacitor should be placed very close to pin 4 and connected directly to a ground plane. If low-gain selection for LNA 2 is required, connect pin 7 directly to the ground plane with a very short printed circuit board trace. Good grounding is critical for this device. The backside ground plane should be as close as possible. See Figure 1 for printed circuit board layout.

Typical Operating Circuit

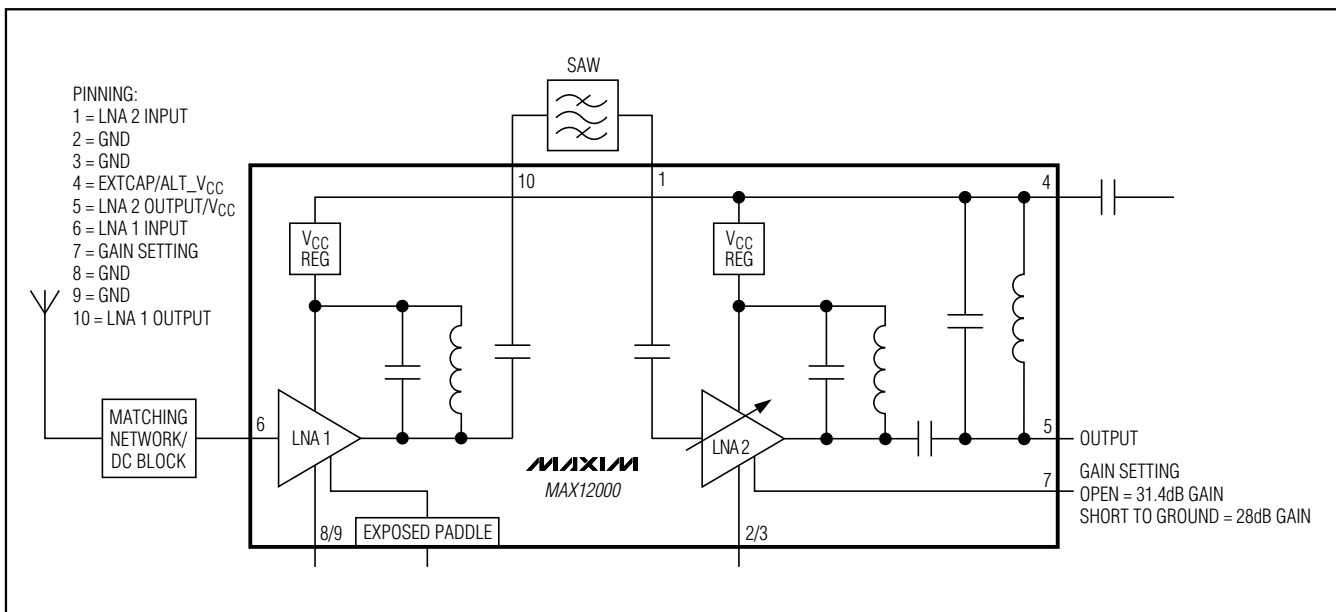

1575MHz GPS Front-End Amplifier

MAX12000

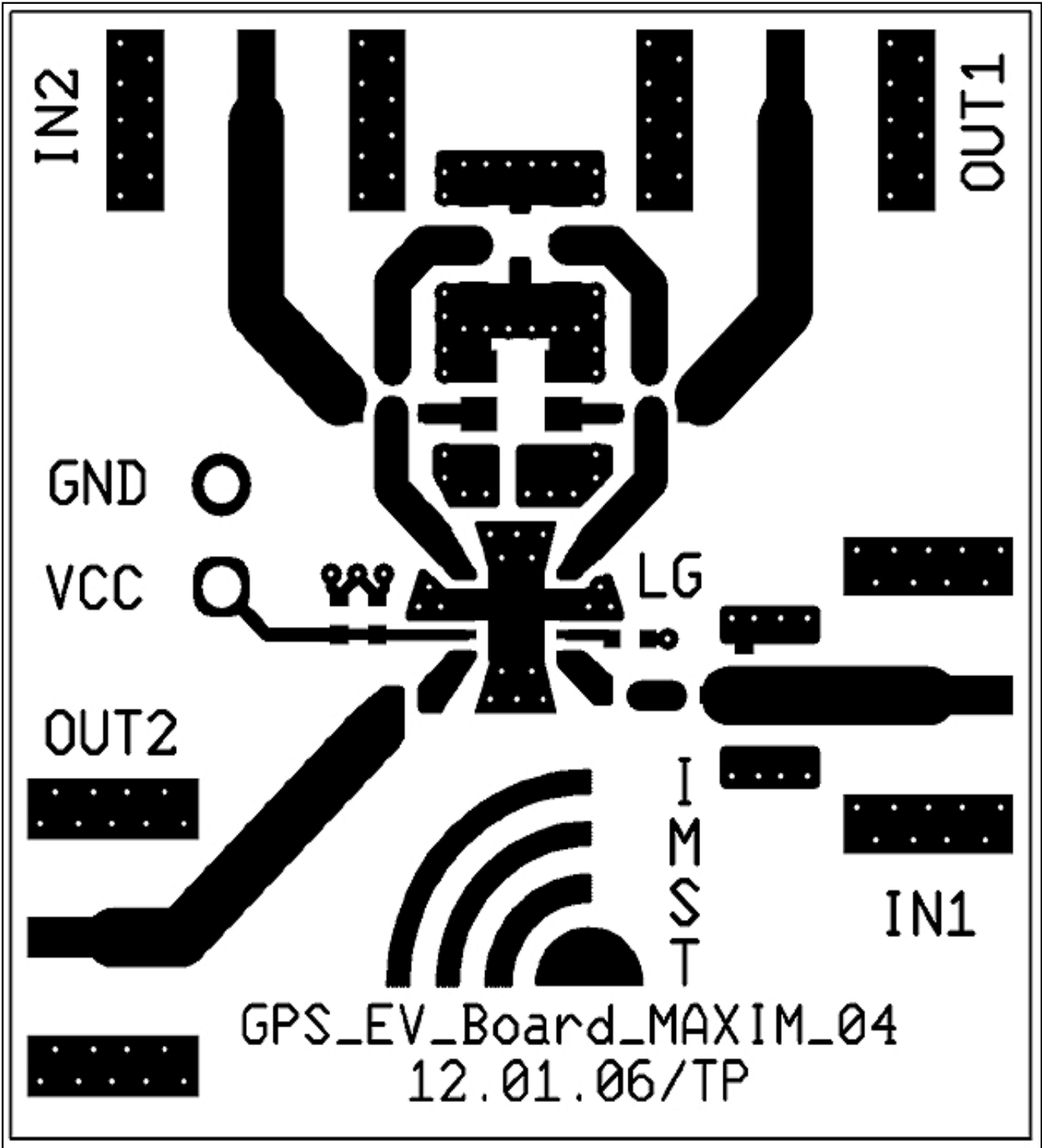
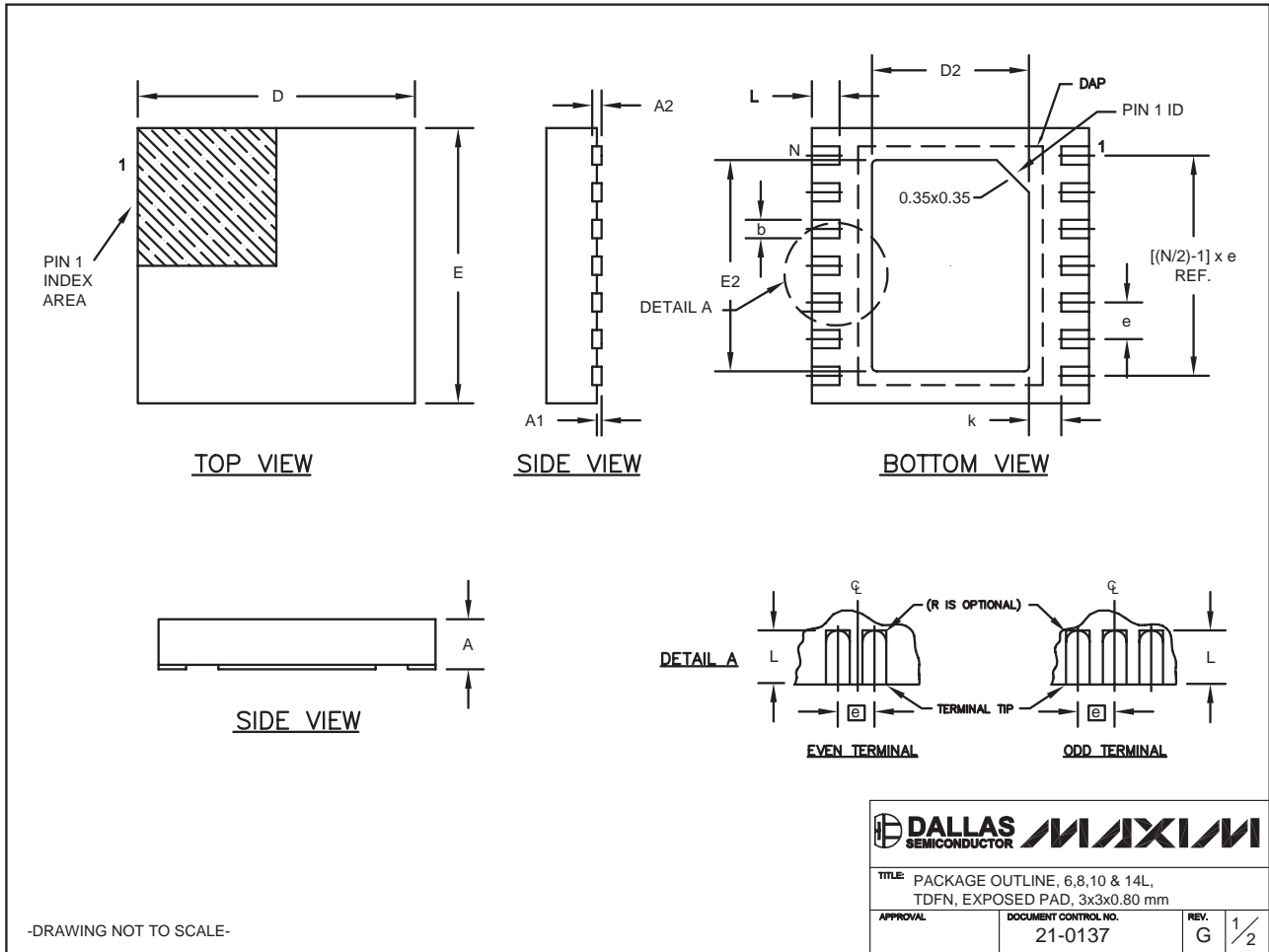

Figure 1. Layout of the Evaluation Board Realized on 0.8mm FR4 (Not to Scale)

1575MHz GPS Front-End Amplifier

Package Information

(The package drawing(s) in this data sheet may not reflect the most current specifications. For the latest package outline information go to www.maxim-ic.com/packages.)



1575MHz GPS Front-End Amplifier

MAX12000

Package Information (continued)

(The package drawing(s) in this data sheet may not reflect the most current specifications. For the latest package outline information go to www.maxim-ic.com/packages.)

COMMON DIMENSIONS		
SYMBOL	MIN.	MAX.
A	0.70	0.80
D	2.90	3.10
E	2.90	3.10
A1	0.00	0.05
L	0.20	0.40
k	0.25 MIN.	
A2	0.20 REF.	

PACKAGE VARIATIONS								
PKG. CODE	N	D2	E2	e	JEDEC SPEC	b	[(N/2)-1] x e	DOWNBONDS ALLOWED
T633-1	6	1.50±0.10	2.30±0.10	0.95 BSC	MO229 / WEEA	0.40±0.05	1.90 REF	NO
T633-2	6	1.50±0.10	2.30±0.10	0.95 BSC	MO229 / WEEA	0.40±0.05	1.90 REF	NO
T833-1	8	1.50±0.10	2.30±0.10	0.65 BSC	MO229 / WEEC	0.30±0.05	1.95 REF	NO
T833-2	8	1.50±0.10	2.30±0.10	0.65 BSC	MO229 / WEEC	0.30±0.05	1.95 REF	NO
T833-3	8	1.50±0.10	2.30±0.10	0.65 BSC	MO229 / WEEC	0.30±0.05	1.95 REF	YES
T1033-1	10	1.50±0.10	2.30±0.10	0.50 BSC	MO229 / WEED-3	0.25±0.05	2.00 REF	NO
T1433-1	14	1.70±0.10	2.30±0.10	0.40 BSC	----	0.20±0.05	2.40 REF	YES
T1433-2	14	1.70±0.10	2.30±0.10	0.40 BSC	----	0.20±0.05	2.40 REF	NO

NOTES:

- ALL DIMENSIONS ARE IN mm. ANGLES IN DEGREES.
- COPLANARITY SHALL NOT EXCEED 0.08 mm.
- WARPAGE SHALL NOT EXCEED 0.10 mm.
- PACKAGE LENGTH/PACKAGE WIDTH ARE CONSIDERED AS SPECIAL CHARACTERISTIC(S).
- DRAWING CONFORMS TO JEDEC MO229, EXCEPT DIMENSIONS "D2" AND "E2", AND T1433-1 & T1433-2.
- "N" IS THE TOTAL NUMBER OF LEADS.
- NUMBER OF LEADS SHOWN ARE FOR REFERENCE ONLY.

-DRAWING NOT TO SCALE-

			
TITLE PACKAGE OUTLINE, 6,8,10 & 14L, TDFN, EXPOSED PAD, 3x3x0.80 mm			
APPROVAL	DOCUMENT CONTROL NO.	REV.	2/2
	21-0137	G	

Maxim cannot assume responsibility for use of any circuitry other than circuitry entirely embodied in a Maxim product. No circuit patent licenses are implied. Maxim reserves the right to change the circuitry and specifications without notice at any time.

Maxim Integrated Products, 120 San Gabriel Drive, Sunnyvale, CA 94086 408-737-7600 _____ **9**