

# Crawler Kit for the Parallax Small Robot (#30055)

## The Crawler Kit Rev B

This kit allows your Parallax Small Robot to walk on six legs. Assembly takes approximately 60 minutes to complete. Before getting started, take an inventory of the parts in your kit. Use **Fig 1** to identify each part to the parts list. Parallax Boe-Bot® Robot (#28132 or #28832), ActivityBot (#32500), ActivityBot 360° (#32600) and Robot Shield with Arduino (#32335) are sold separately.



## Recommended Tools

- Small needle-nosed pliers
- Phillips #2 point screwdriver
- A sharp-tipped hobby knife, such as an X-Acto® knife -OR- A hand drill with 7/64"(2.8 mm) bit

## WARNING!

DO NOT use electric screwdrivers with this kit. Please assemble using hand tools only to avoid damaging your Crawler.



## Parts List

### Item Qty Description

A	(2)	Crawler Side
B	(2)	Servo Horn
C	(4)	End Leg
D	(6)	Rubber Feet, Black
E	(4)	#4 1/16" Nylon Spacer
F	(2)	#4 1/8" Nylon Spacer
G	(4)	Extension Arm
H	(2)	3/4" Hex Nylon Standoff
I	(4)	4-40 1" Hex Nylon Standoff
J	(2)	4-40 5/8" Phillips Pan Head Screw
K	(6)	4-40 1/2" Phillips Self Tapping Screw
L	(10)	4-40 3/8" Phillips Pan Head Screw
M	(6)	4-40 Hex Nut
N	(6)	4-40 Nylon Insert Locknut
O	(2)	Center Leg
P	(6)	4-40 1/4" Phillips Pan Head Screw
Q	(12)	Plastic Screw Cover, Black
R	(8)	#4 .031" Nylon Washer, Large

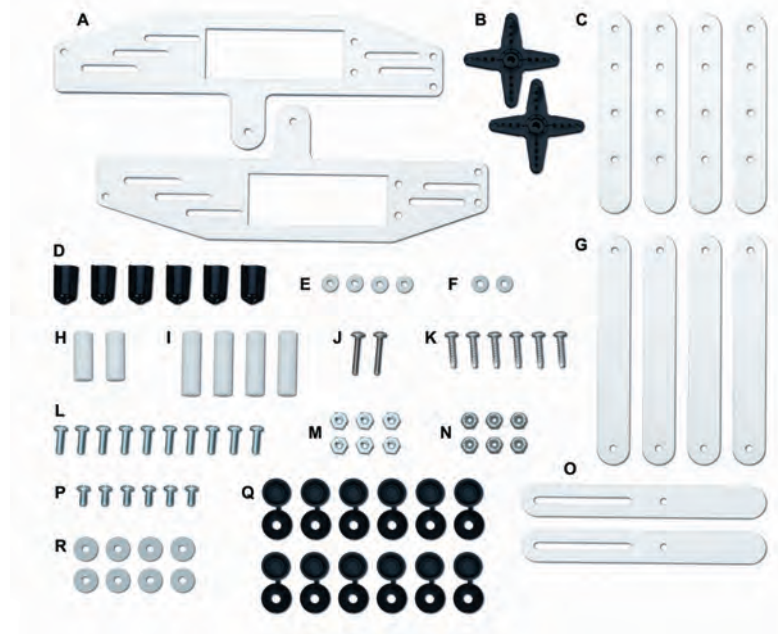

**Fig 1**

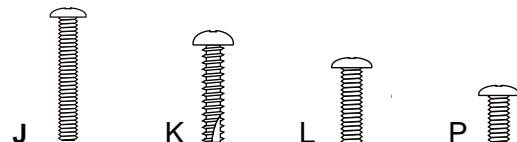

## Step #1 Assembling the Crawler Sides

Item	Qty	Description
(A)	(2)	Crawler Side
(H)	(2)	3/4" Hex Nylon Standoff
(I)	(4)	1" Hex Nylon Standoff
(L)	(6)	3/8" Phillips Pan Head Screw

Following **Fig 2**, install the Nylon standoffs (H & I) on the Crawler sides (A) using the screws (L). The shorter standoffs (H) go to the center, and the longer standoffs (I) are mounted by the ends. Tighten screws firmly. Each side panel should be a mirror image of the other. Before moving on position the pieces exactly as they appear in **Fig 3** and double check your work and proceed to **Step #2**.

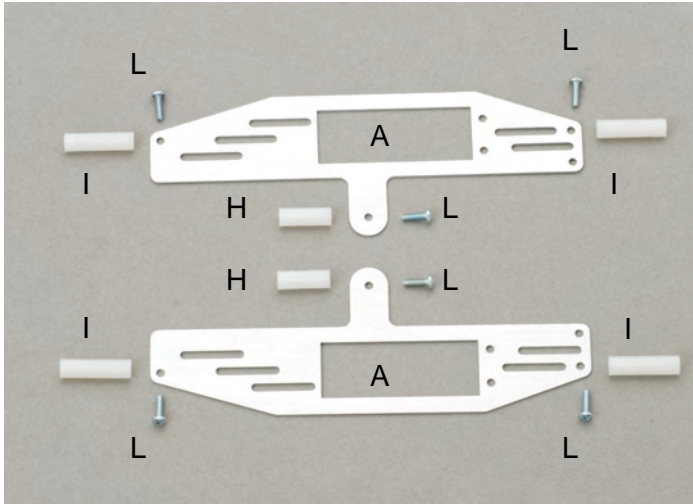

Fig 2

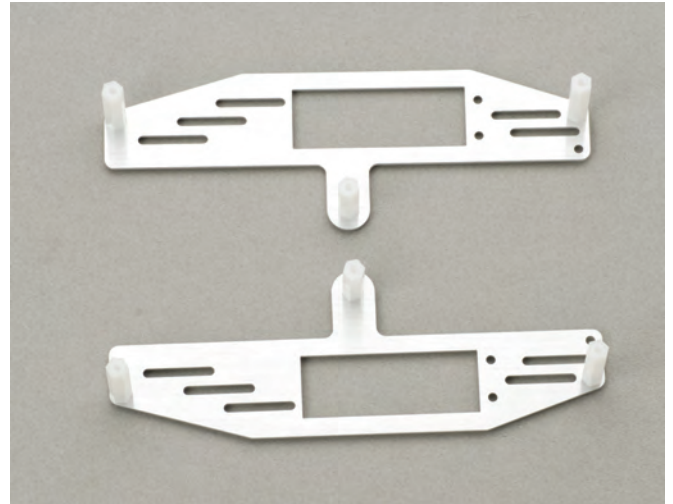

Fig 3

## Step #2 Installing the End Legs

Item	Qty	Description
(C)	(4)	End Leg
(K)	(4)	1/2" Phillips Self-Tapping Screw
(Q)	(4)	Plastic Screw Cover

Use **Fig 4** as a guide to install end legs. Insert self-tapping screw (K) through screw cover (Q) and middle hole of end leg (C). Screw into standoffs (I). Tighten, then loosen until legs can spin freely but are not floppy. Before continuing, position the pieces exactly as they appear in **Fig 5**. Double check your work and then proceed to **Step #3**.

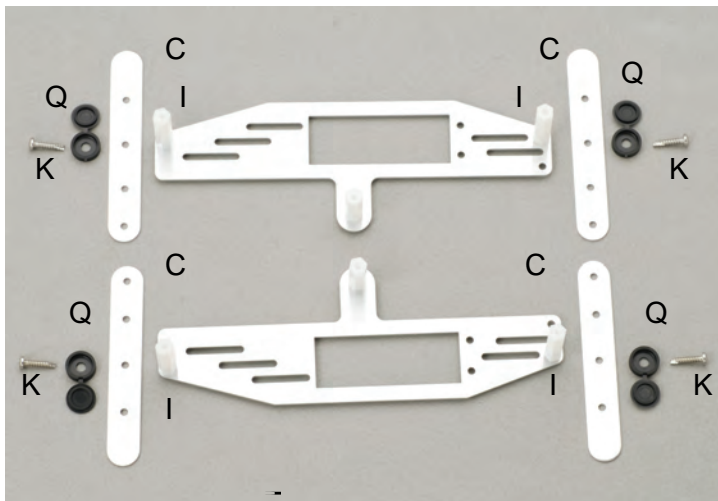

Fig 4



Fig 5

### Step #3 Drilling the Servo Horns

Item	Qty	Description
(B)	(2)	Servo Horn

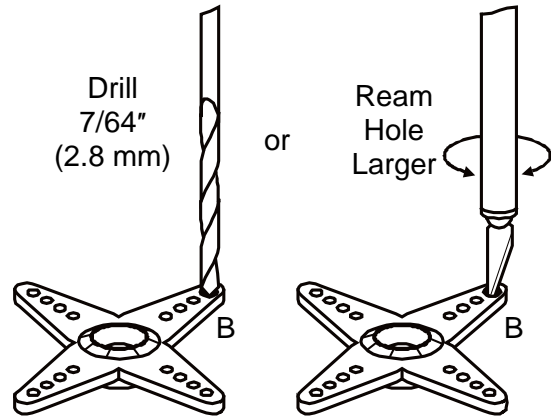

Fig #6

Use **Fig 6** as a guide. The servo horns (B) need to have one of the outside holes enlarged. If you do not have a 7/64" drill bit you can enlarge the hole with a hobby knife. When using a knife, carve from each side to keep the hole even. Make the hole a little smaller than the screw so that threads will be made when the screw goes in. Compare your work to **Fig 7** then proceed to **Step #4**.

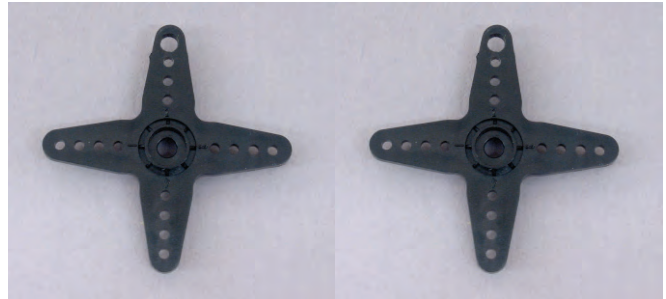

Fig 7

### Step #4 Assembling Center Legs

Item	Qty	Description
(J)	(2)	5/8" Phillips Pan Head Screw
(Q)	(2)	Plastic Screw Cover
(G)	(4)	Extension Arm
(R)	(4)	.031" Nylon Washer, Large
(O)	(2)	Center Leg
(F)	(2)	1/8" Nylon Spacer
(B)	(2)	Servo Horn
(N)	(2)	Nylon Insert Locknut

Use **Fig 8** as a guide. Insert screw (J) through screw cover (Q). Next insert screw through the hole of the extension arm (G). Add a washer (R), another extension arm (G), then another nylon washer (R). Insert the screw through the hole of the center leg (O), and then add the nylon spacer (F). Screw into the large hole on servo horn (B). The screw will make its own threads going into the servo horn. Tighten, and then loosen until all parts can spin freely but are not floppy. Next screw locknut (N) onto screw (J) until snug against the servo horn (See **Fig 9**). Before continuing, position the pieces exactly as they appear in **Fig 9**. Double check your work then proceed to **Step #5**.

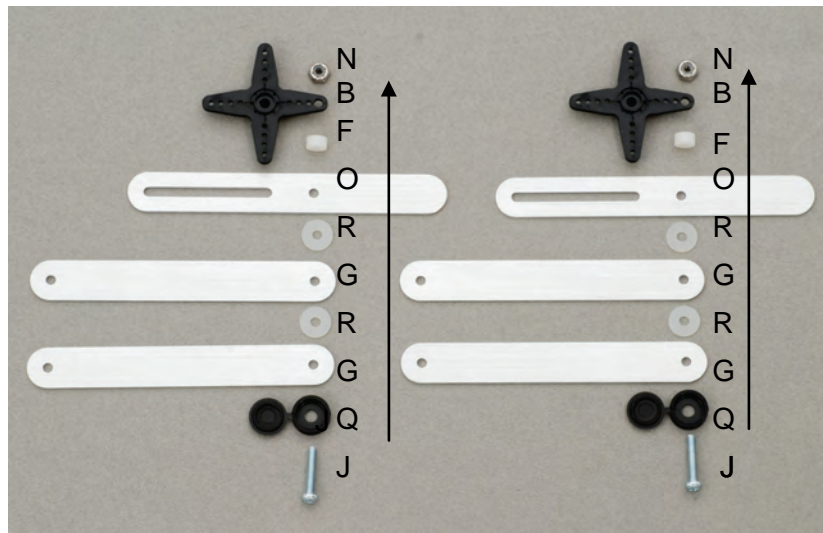

Fig 8



Fig 9

## Step #5 Installing Center Legs

Item	Qty	Description
(K)	(2)	½" Phillips Self-Tapping Screw
(Q)	(2)	Plastic Screw Cover

Use **Fig 10** as a guide to install the center leg assemblies you just built. Insert self-tapping screws (K) through screw covers (Q). Insert the screw through the long slide hole of the leg assembly. Screw into standoff (H). Tighten, then loosen until each leg can spin freely but is not floppy. Before moving on, position the pieces exactly as they appear in **Fig 11** with the top extension arm to the left. Double check your work then proceed to **Step #6**.

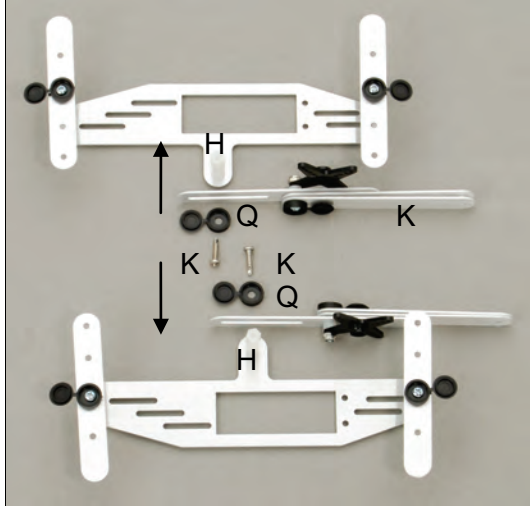

Fig 10



Fig 11

## Step #6 Connecting Ext. Arms to Legs

Item	Qty	Description
(L)	(4)	3/8" Phillips Pan Head Screw
(Q)	(4)	Plastic screw cover
(R)	(4)	.031" Nylon Washer, Large
(E)	(4)	1/16" Nylon Spacer
(N)	(4)	Nylon Insert Locknut

Use **Fig 12** as a guide. Be sure extension arms are aligned as shown in **Fig 11**. Insert screw (L) through screw cover (Q). Next insert screw through hole of leg (C), then through the large nylon washer (R), and through the extension arm (G). Next insert the screw through the nylon spacer (E) and tighten the locknut (N) from back of the extension arm. Tighten, then loosen, until legs can spin freely but are not floppy. Before moving on, position the pieces exactly as they appear in **Fig 13** and **Fig 14**. Double check your work then proceed to **Step #7**.

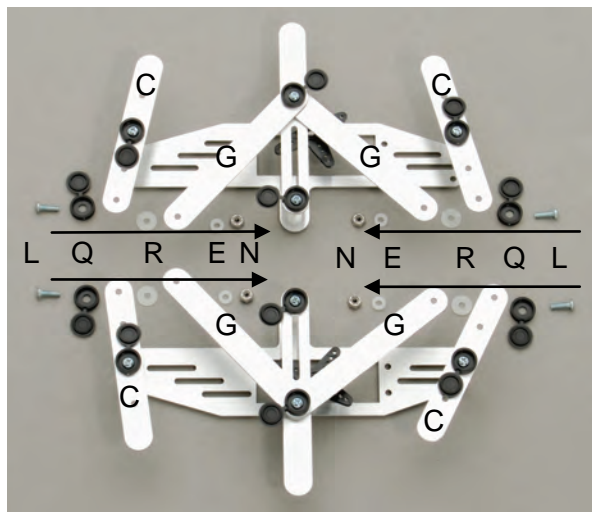

Fig 12



Fig 13



Fig 14

## Step #7 Installing the Rubber Feet

Item	Qty	Description
(D)	(6)	Rubber Feet

Use **Fig 15** as a guide.

Be careful not to bend the legs. Slide the rubber feet (D) onto each leg as shown in **Fig 16**. Double check your work then proceed to **Step #8**.



Fig 15



Fig 16

## Step #8 Preparing your Robot

Item	Qty	Description
(1)	(1)	Your robot

Use **Fig 17** as a guide. To install the Crawler Kit, some changes must be made to your robot. First, remove the wheels and ball caster. Then, remove your control board to prevent the chance of damaging it during the installation, and save the screws for the final step

If you have an original ActivityBot, remove the external encoders.

If your robot has a 5AA battery pack or Li-Ion battery pack, you will need to remove it. This will make removing and re-mounting the servos easier, if needed.

Next, compare your servo installation to **Fig 17**. If your servo mounting tabs are installed inside the chassis, they must be removed and reinstalled with tabs sitting outside the chassis. Make sure the servo head is toward the middle of the chassis then proceed to **Step #9**.

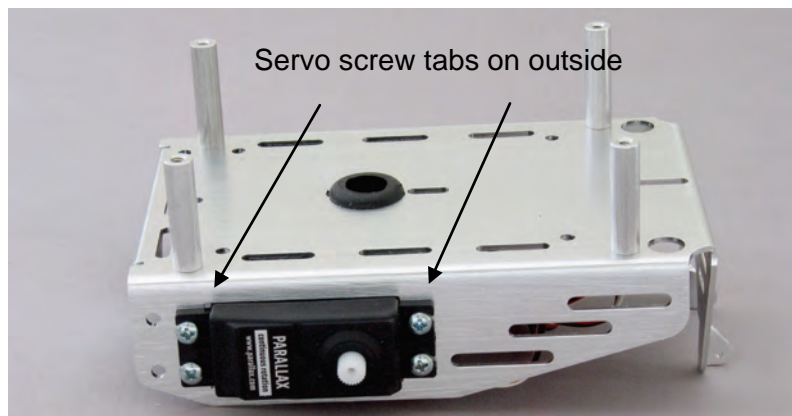

Fig 17

## Step #9 Install Crawler Sides

Item	Qty	Description
(P)	(6)	¼" Phillips Pan Head Screw
(M)	(6)	Hex Nut
	(2)	Servo Horn Screw (from your servos)

Use **Fig 18** as a guide. Line up the Crawler Side Panels to your robot and slip the servo horn on the servo. Secure the Crawler panels with screws (P) and nuts (M). If using a 5-cell or Li-ion battery pack, install the rightmost screw shown in **Fig 18** with the screw-head facing inside the chassis, and nut connected on the outside.

Re-install the servo horn screw. Compare your work to **Fig 19-21**. Confirm that the leg screws are secure but loose enough for the screw caps to slide side to side with a slight resistance. Re-install the battery pack removed in **Step #8**. Close the screw covers then proceed to **Step #10**.

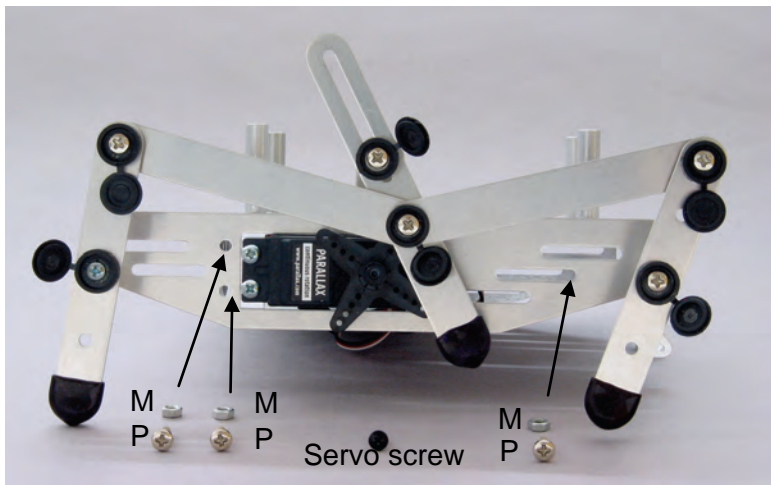

Fig 18



Fig 19

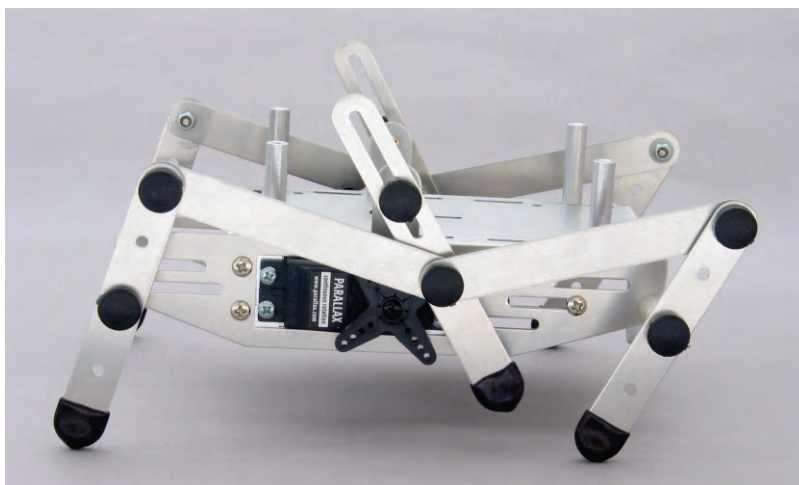

Fig 20

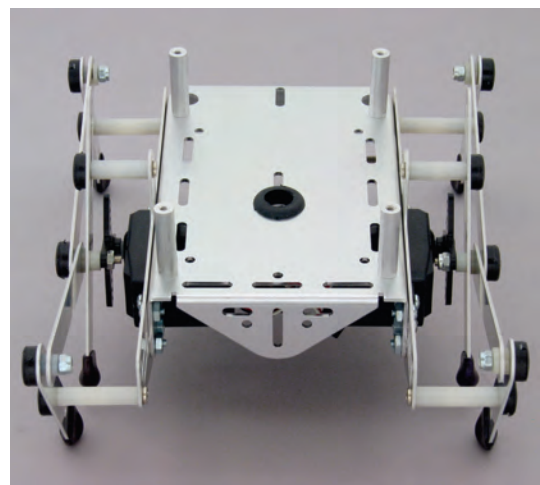

Fig 21

## **Step #10    Install the Board of Education**

<u>Item</u>	<u>Qty</u>	<u>Description</u>
	(1)	Control Board
	(1)	Assembled Walker Kit
	(4)	Screws, from your robot

Use **Fig 22** as a guide. Line up the holes in your control board with the standoffs on the chassis and secure in place with screws. Next connect the servos to the servo ports.

**Congratulations, assembly is complete!**

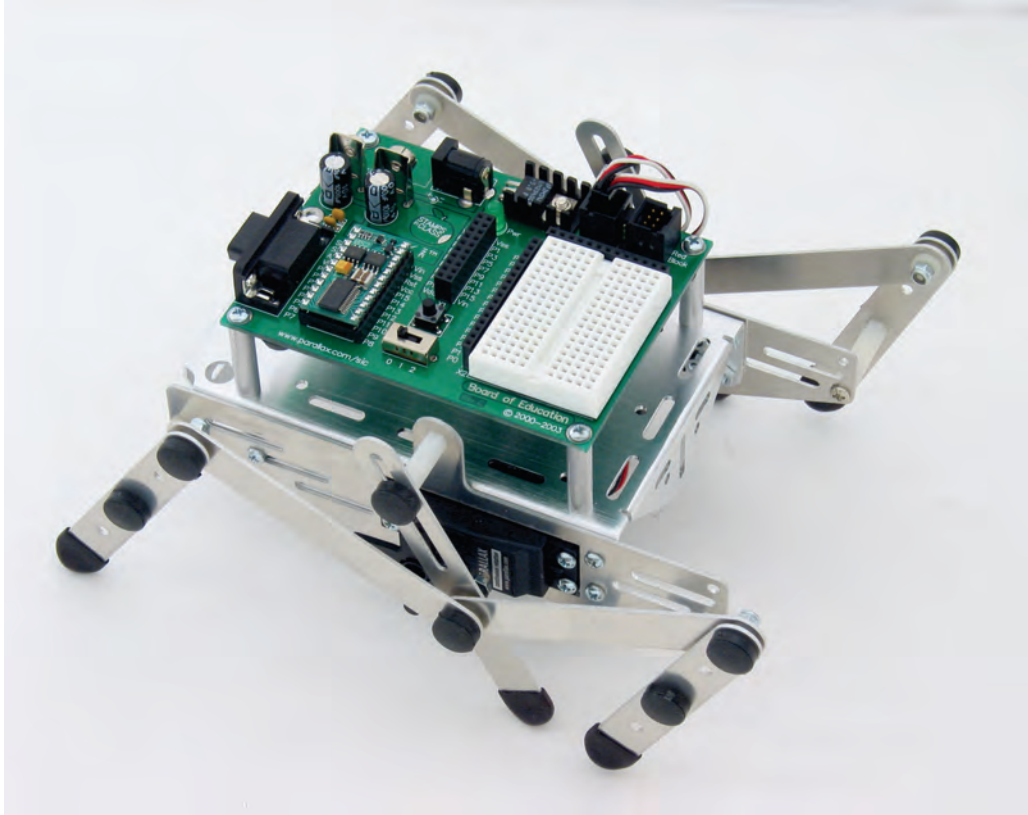

**Fig 22**

## **Troubleshooting your Crawler**

### **Legs bind when walking**

Check all joints and loosen as needed. Joints should always move freely without being too loose.

### **Legs hit when walking**

Improper assembly of unit or legs bent. Legs should never hit each other while moving.

### **Legs move when not supposed to**

The servos might not be centered properly. If using servos that have an external potentiometer adjustment port, check its product documentation for information on how to center the servos.

## Modifying Programs to be Crawler-Friendly

The Crawler can run almost any navigation program written for the Boe-Bot<sup>®</sup>, ActivityBot\*, ActivityBot 360°, or Shield-Bot robots. However, since the ground speed of a rolling wheel and the ground speed of the crawler legs may be different, some programs that send a wheeled robot moving a certain distance or executing a turn of certain number of degrees may need to be adjusted.

Full example programs are available for download from the Crawler Kit product page – just go to <http://www.parallax.com> and search “30055”.

### Boe-Bot

Any navigation routine for a specific maneuver can be easily adapted by changing the PBASIC program's FOR...NEXT loop *EndValue* arguments for each set of PULSOUT commands.

### Shield-Bot

Adapting your Arduino program is simple. Adjust your speed and timing by changing your code's `servoRight.writeMicroseconds();`, `servoLeft.writeMicroseconds();`, and `delay();` commands.

### ActivityBot (original, with external encoders)

The ActivityBot with external encoders cannot be used with BlocklyProp ActivityBot code directly, since the Robot blocks require encoder signal input.

For C code, ActivityBot programs will work with Crawler Legs, but the following code must be added inside of the `main` function:

```
drive_feedback(0);
```

This tells your ActivityBot not to expect any encoder feedback while performing navigation maneuvers. Commands such as `drive_goto();` that rely on precise distances will not work properly with Crawler Legs as they require encoder feedback. Try experimenting with `drive_speed();` and `pause();` functions in your program instead to achieve the desired outcome.

Wheeled ActivityBots use encoders for precision distance commands, but to install the Crawler kit these encoders must be removed. Removing the encoders could make it necessary to re-center your servos manually, even if your robot was previously calibrated. If one or both of your servos keep rotating when they should be stopped, use the following code commands and follow the centering instructions in the product documentation for the High-Speed Continuous Rotation Servo (#900-00025).

```
#include "servo.h"

int main()
{
  servo_set(12, 1500);
  servo_set(13, 1500);
}
```

### ActivityBot 360° (with Feedback 360° servos, no external encoders)

BlocklyProp blocks and C libraries for the ActivityBot do not rely on external encoders for position feedback, so no adjustment to code needs to be made for centering the servos. You may need to adjust Robot drive speed and Robot drive distance blocks to account for the difference in ground speed between the wheels and the Crawler Legs.