



ZMOTIONS200ZCOG

**ZMOTION™ Intrusion
Detection Development
Kit**

User Manual

UM023301-0411



Warning: DO NOT USE IN LIFE SUPPORT SYSTEMS.

LIFE SUPPORT POLICY

ZILOG'S PRODUCTS ARE NOT AUTHORIZED FOR USE AS CRITICAL COMPONENTS IN LIFE SUPPORT DEVICES OR SYSTEMS WITHOUT THE EXPRESS PRIOR WRITTEN APPROVAL OF THE PRESIDENT AND GENERAL COUNSEL OF ZILOG CORPORATION.

As used herein

Life support devices or systems are devices which (a) are intended for surgical implant into the body, or (b) support or sustain life and whose failure to perform when properly used in accordance with instructions for use provided in the labeling can be reasonably expected to result in a significant injury to the user. A critical component is any component in a life support device or system whose failure to perform can be reasonably expected to cause the failure of the life support device or system or to affect its safety or effectiveness.

Document Disclaimer

©2011 Zilog Inc. All rights reserved. Information in this publication concerning the devices, applications, or technology described is intended to suggest possible uses and may be superseded. ZILOG, INC. DOES NOT ASSUME LIABILITY FOR OR PROVIDE A REPRESENTATION OF ACCURACY OF THE INFORMATION, DEVICES, OR TECHNOLOGY DESCRIBED IN THIS DOCUMENT. ZILOG ALSO DOES NOT ASSUME LIABILITY FOR INTELLECTUAL PROPERTY INFRINGEMENT RELATED IN ANY MANNER TO USE OF INFORMATION, DEVICES, OR TECHNOLOGY DESCRIBED HEREIN OR OTHERWISE. The information contained within this document has been verified according to the general principles of electrical and mechanical engineering.

ZMOTION, Z8 Encore! and Z8 Encore! XP are registered trademarks of Zilog Inc. All other product or service names are the property of their respective owners.

Revision History

Each instance in the table below reflects a change to this document from its previous edition. For more details, refer to the corresponding pages and appropriate links in the table below.

Date	Revision Level	Description	Page No.
April 2011	01	Original issue	All

Table of Contents

Revision History	iii
Table of Contents	iv
Introduction	1
Kit Contents	2
System Requirements	5
Safeguards	5
ZMOTION Intrusion Detection Development Board	6
Features	7
MCU Features	7
ZMOTION Intrusion Detection Development Kit Lens and Pyroelectric Sensor	9
Lens Mounting Options	9
Pyroelectric Sensor Option	9
ZMOTION Development Kit Application Software	10
Installing ZDSII and the USB Smart Cable	12
Installing the USB Smart Cable	12
Connecting the USB Smart Cable	15
Installing the FTDI USB to Serial Driver	17
Downloading and Running the Sample Project	17
Making Changes to the ZMOTION_Intrusion_Demo Project	22
Board Design Information	24
Customer Support	28

Introduction

Zilog's ZMOTION Intrusion Detection Development Kit provides a general-purpose platform for evaluating the capabilities and operation of the ZMOTION Intrusion Detection MCU, which features Zilog's passive infrared (PIR) technology. The ZMOTION Family of Motion Detection products includes a series of high-performance microcontrollers with integrated motion detection algorithms. A variety of included lenses and pyroelectric sensors demonstrate the flexibility of the integrated motion detection algorithms to provide the best possible performance for a range of lighting, intrusion detection and security-related control applications.

The Z8FS021 MCU, a prominent member of the ZMOTION Family, combines the programmability and rich peripheral set of Zilog's Flash Z8 Encore! XP® Family of MCUs with built-in motion detection software algorithms to provide the functions necessary for PIR motion detection applications. These motion detection algorithms comprise Zilog's PIR technology and run in the background while control and status of the motion detection engine is accessed through a software Application Programmer Interface (API). As a result, the designer can create his or her own application-specific software while taking advantage of Zilog's ZMOTION Motion Detection Technology.

Within this kit, API settings are provided to match the Engine operation to each of the lens and pyroelectric sensor combinations provided.

For more details about the ZMOTION MCU, refer to the [ZMOTION Detection Module Product Specification \(PS0284\)](#), available for download at www.zilog.com.

Kit Contents

The ZMOTION Intrusion Detection Development Kit contains the following hardware, software and documentation:

Hardware

- ZMOTION Development Board
- USB Smart Cable Debugger
- 1.2" Focal Flat Lens Holder
- Selection of lenses
- RE200B Pyroelectric Sensor mounted on the Development Board
- Mini-USB serial cable
- Wall mount mini-USB 5V DC power supply¹
- An assortment of mounting hardware

Software (on CD-ROM)

- ZDSII – Z8 Encore! IDE with ANSI C-Compiler
- Sample Code: ZMOTION_Intrusion_Demo

Documentation

- ZMOTION Intrusion Detection Development Kit Quick Start Guide (QS0078)
- ZMOTION Family Technical Documentation (on CD-ROM)
 - ZMOTION Intrusion Detection Product Specification (PS0288)
 - ZMOTION Intrusion Detection Product Brief (PB0230)

1. Zilog recommends using only the power supply provided in the ZMOTION Intrusion Detection Development Kit.

- ZMOTION Detection and Control Product Specification (PS0285)
- ZMOTION Detection and Control Product Brief (PB0225)
- ZMOTION Detection Module Product Specification (PS0284)
- ZMOTION Detection Module Product Brief (PB0223)
- ZMOTION Lens and Pyroelectric Sensor Product Specification (PS0286)
- ZMOTION Intrusion Detection Development Kit User Manual (UM0233)
- ZMOTION Intrusion Detection Development Kit Quick Start Guide (QS0078)
- ZMOTION – A New PIR Motion Detection Architecture White Paper (WP0017)
- ZMOTION Detection Lens and Pyro Sensor Configuration Guide (WP0018)
- Board Schematic, assembly drawing and artwork

The contents of the kit are shown in Figure 1.

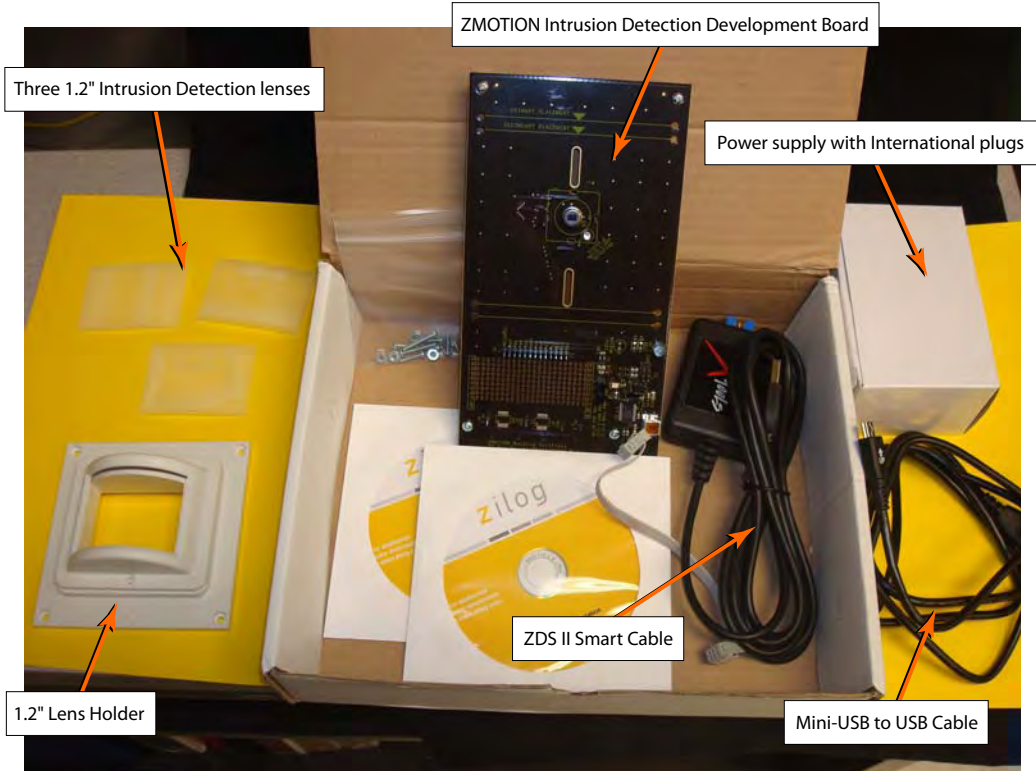

Figure 1. ZMOTION Intrusion Detection Development Kit Contents

Sample code files are included on the ZMOTION Sample Applications CD, and are located in the ZMOTION_Intrusion_Demo folders.

System Requirements

An IBM PC (or compatible computer) with the following minimum configurations is required:

- Microsoft Windows 7, Windows XP Professional SP1, Windows 2000 SP3, Windows NT 4.0 SP6
- Pentium II/233MHz processor or higher up to Pentium IV, 2.8GHz
- 96MB RAM or more
- 25MB hard disk space or more
- Super VGA video adapter
- CD-ROM drive
- USB 2.0 interface port

Installation

For details about installation and setup, refer to the Using the ZMOTION Intrusion Detection Development Kit Quick Start Guide (QS0078).

Safeguards

The following precaution must be observed when working with the devices described in this document.



Caution: Always use a grounding strap to prevent damage resulting from electrostatic discharge (ESD).

ZMOTION Intrusion Detection Development Board

Zilog's ZMOTION Intrusion Detection Development Board is a development and prototyping platform for the ZMOTION Intrusion Detection silicon and software as well as for lens/pyroelectric sensor/silicon and software bundled solutions. The Board provides the user with a tool to evaluate the many features of ZMOTION PIR technology, as well as the actual performance of each lens and pyro combination.

-
- **Note:** Attach the Intrusion lens holder to the Board using the primary placement set of holes, which are indicated in Figure 2.
-

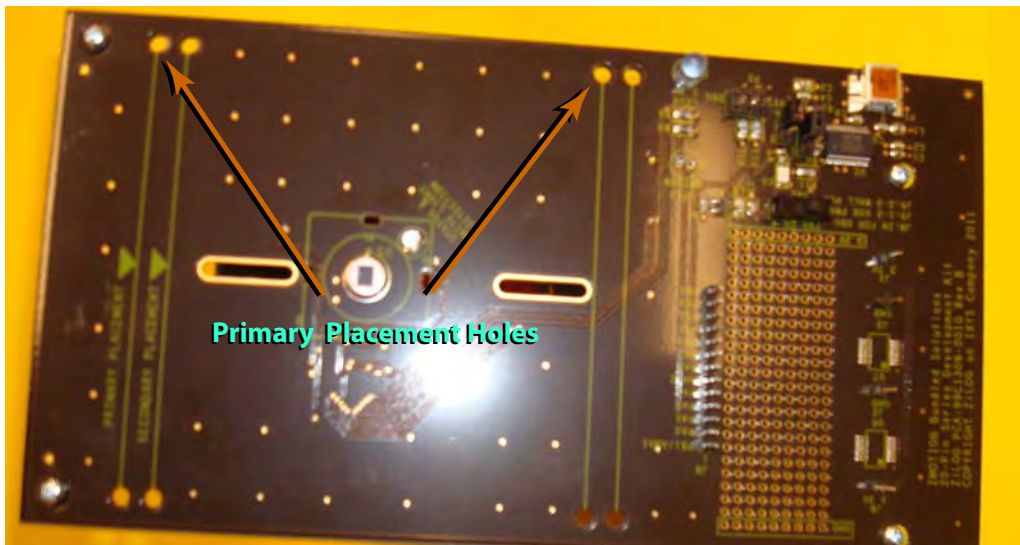

Figure 2. ZMOTION Intrusion Detection Development Board

Features

The ZMOTION Intrusion Detection Development Board features the following elements:

- Z8FS021 ZMOTION Detection MCU (20-pin SSOP)
- Mini-USB power connector and serial interface
- Power-On and Detection LED
- On-chip debugger interface
- Board openings for an assortment of lens holders and clip-on lens attachments

► **Note:** The upper set of holes on the board is used to attach the 1.2" lens holders (see Figure 2).

- Prototyping area
- 2.7V–3.6V operating voltage with 5V tolerant inputs

MCU Features

The Z8FS021 ZMOTION Intrusion Detection MCU combines the programmability and rich peripheral set of Zilog's Flash Z8 Encore! XP Family of MCUs with built-in motion detection software algorithms to provide the functions necessary for PIR motion detection applications.

The Z8FS021 MCU includes the following features:

- High performance eZ8® MCU core
- 2KB in-circuit programmable Flash memory available for application code
- Single-pin debug with unlimited breakpoints

- Flexible clocking scheme
- Internal precision oscillator running at 5.53MHz
- External oscillator operating up to 20MHz
- Sigma Delta ADC
- Up to 6 single-ended channels or 3 differential channels available
- On-chip analog comparator with independent programmable reference voltage
- Full-duplex UART with dedicated BRG
- Two 16-bit timers with input capture, output compare and PWM capability (11 modes total)
- Watchdog timer (WDT) with dedicated internal oscillator
- Up to 20 vectored interrupts
- 6 to 25 I/O pins depending upon package
- 2.7V to 3.6V operating voltage with extended operating temperature range -40°C to $+105^{\circ}\text{C}$
- Zilog PIR technology controlled and monitored via software API registers
- Selection capability from an assortment of lenses and pyroelectric sensors to best fit your application
- API settings provided for each lens and pyroelectric sensor combination
- Directly supports 1 or 2 pyroelectric sensors
- Sensitivity control, range control and directionality detection
- Extended detection modes for occupancy sensing
- Low power modes
- White light detection and pet immunity

ZMOTION Intrusion Detection Development Kit Lens and Pyroelectric Sensor

The ZMOTION Intrusion Detection Development Kit includes three different types of lenses to fill a wide variety of intrusion detection and security applications. These applications also demonstrate the flexibility, and superior performance of Zilog's PIR motion detection technology.

Please refer to the ZMOTION Lens and Pyroelectric Sensor Product Specification (PS0286) for part-specific details about the individual lenses and pyroelectric sensors. Refer to the ZMOTION Intrusion Detection Development Kit Quick Start Guide (QS0078) for specific installation instructions for the lenses.

Lens Mounting Options

The ZMOTION Development Board supports a lens holder option for each of the 1.2" focal length intrusion lenses, as indicated in Table 1. For lens installation instructions, please refer to the [ZMOTION Intrusion Detection Development Kit Quick Start Guide \(QS0078\)](#).

Table 1. Lens Mounting Options

Lens Mounting	Supported Lenses
Flat Lens Holder 1.2 Focal	WA 1.2 GI 12 V4
	VB 1.2 GI V1
	LR 1.2 GI 12 V3

Pyroelectric Sensor Option

The ZMOTION Intrusion Detection Development Kit includes one type of pyroelectric sensor, the Basic Dual Element sensor, part number RE200B-P, which is mounted directly on the Board.

ZMOTION Development Kit Application Software

The ZMOTION application software includes the ZMOTION_Intrusion_Demo motion detection project, which is described in this section.

ZMOTION_Intrusion_Demo

The ZMOTION_Intrusion_Demo project demonstrates the basic motion detection functionality of the ZMOTION Development Board. The MCU included with the Board is programmed with this project.

Each lens type is supported by an associated lens configuration header file which displays a name format of `API_INIT_xx.h`. Header files for all supported lens types are included in the include project folder of the ZMOTION_Intrusion_Demo project. The `main.c` source file contains the `include` directive to add the header file to the project. Changes to these header files should not be required, but any modifications you make should be made to a copy of the original header file; *do not modify the original versions*. As new lens types are added to the ZMOTION family, an associated lens configuration file is made available on the Zilog website.

Table 2 lists additional project features that can be modified or enabled in `main.c` and `main.h`.

Table 2. Additional Project Features

Feature	File	Define/Variable	Default Values
LED on time duration	<code>main.c</code>	<code>cMDDelayTime</code>	<code>DELAY_1SEC</code> (1 second)
White Light Immunity On/Off	<code>main.h</code>	<code>WHITE_LIGHT</code>	0 (Off)
White Light Threshold	<code>main.h</code>	<code>WHITE_LIGHT_THRESH_DEF</code>	0x1F (Max)
White Light Anti-Jam On/Off	<code>main.h</code>	<code>WHITE_LIGHT_ANTI_JAM_DEF</code>	0 (Off)
Detailed Status Reporting On/Off	<code>main.h</code>	<code>VERBOSE</code>	0 (Off)
Lens Support	<code>main.c</code>	<code>#include "API_INIT_xx.h"</code>	<code>API_INIT_09.h</code>

When motion is detected, the LED is turned ON for 1 second (cMDDelayTime). A serial terminal program such as HyperTerminal can be used to view the detection messages from the ZMOTION Development Board (see Figure 3). In the figure, *r045* indicates the version of the application; the *S* following it is displayed when the pyroelectric sensor has become stable and the system is ready to detect motion. When motion is detected, an *M* or *E* is displayed to indicate the type of detection (normal *M*otion or *E*xtended motion), along with the count and a time stamp (in seconds) after power-up.

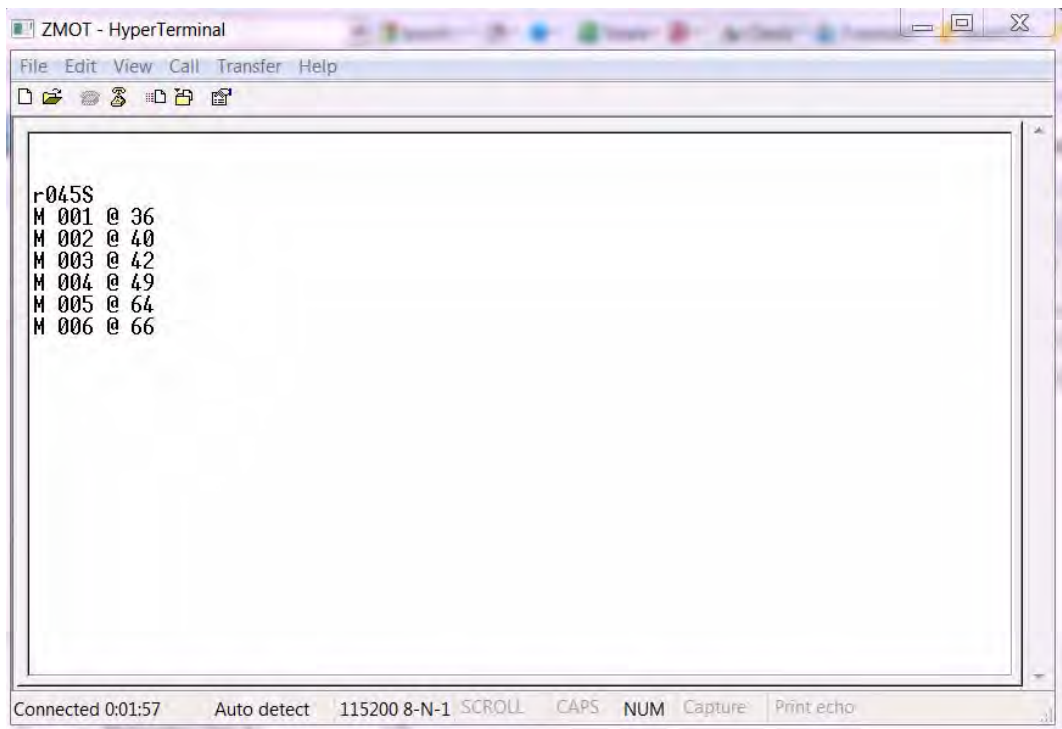

Figure 3. The ZMOTION_Intrusion_Demo project running in HyperTerminal

Installing ZDSII and the USB Smart Cable

Observe the following the steps to install Zilog Developer Studio (ZDSII) and its associated documentation.

1. Insert the ZDSII CD into the CD-ROM drive. The DemoShield installer launches automatically. If DemoShield does not launch automatically, open Windows Explorer, browse to your CD-ROM drive and double-click `launch.exe` to launch DemoShield.
2. From the product installer list, you can choose to install ZDSII alone, or both ZDSII and its associated documentation. You can also copy the documentation directly from your CD-ROM drive to your hard disk using Windows Explorer, or read the documentation directly from the CD-ROM itself.

For customer service and technical support, Zilog recommends that you create an account at support.zilog.com.

Installing the USB Smart Cable

This section describes how to install the USB Smart Cable and associated driver software for your particular operating system.

Windows 7 32/64

Observe the following steps to install the USB Smart Cable for Windows Vista 32-bit systems.

1. Connect the USB Smart Cable to the Host PC. A window message stating **Driver Software Installation** appears.
2. Windows automatically searches the driver; this process can sometimes take a few minutes to complete. In this case, wait for the search to complete, since there is no option to terminate this process immediately. If the driver was previously installed, Windows automatically installs the USB Smart Cable driver. If this is the case, proceed to [Step 9](#). If Win-

downs cannot find the driver, close the Search dialog and continue to Step 3.

3. In the Windows Start menu's **Search programs and files** field, enter `Device Manager` and click the Enter key. A **Device Manager** link will appear in the Start menu's resulting Program list; click to launch it.
4. In the Device Manager, under **Other devices**, right-click **USB Smart Cable**.
5. Select **Update Driver Software**.
6. In the **Update Driver Software - USB Smart Cable** dialog, select the **Browse my computer for driver Software** option.
7. Browse to one of the following driver directories:

For 32-bit versions:

```
<ZDS II Installation Directory>\device drivers\USB\x32  
<ZDS II Installation CD>\device drivers\USB\x32
```

For 64-bit versions:

```
<ZDS II Installation Directory>\device drivers\USB\x64  
<ZDS II Installation CD>\device drivers\USB\x64
```

8. Click **Next** to install the driver. On 32-bit systems, a **Windows Security** dialog will appear; select **Install this driver software anyway**.
9. After the Wizard finishes the installation, click the **Close** button.

Windows Vista, 32-bit OS

Observe the following steps to install the USB Smart Cable for Windows Vista 32-bit systems.

1. Connect the USB Smart Cable to the host PC. The **Found New Hardware** dialog box is displayed.
2. Select **Locate and install the driver software (recommended)**. The **Driver Software Installation** window is displayed, followed by the **Found New Hardware-USB Smart Cable** dialog box.
3. When prompted, select **I don't have the disc. Show me other options**.
4. When prompted, select **Browse my computer for driver software (advanced)**.
5. Browse to the following driver directory:
`<ZDS II Installation Directory>\device drivers\USB`
6. The Windows Security dialog box is displayed; select **Install this driver software anyway**.
7. Upon successful installation, click **Close**.

Windows XP

Observe the following steps to install the USB Smart Cable for Windows XP systems.

1. Connect the Zilog USB device to the host PC. The **Found New Hardware** wizard should activate automatically after connecting the Zilog USB device for the first time. If prompted to connect to Windows Update, select **No, not at this time**.
2. Select **[Install from a list or specific location (Advanced)]**; then click **Next**.

► **Note:** If the Windows Logo testing dialog appears, select **Continue Anyway**.

3. Select **Search for the best driver in these locations and Include this location in search.**
4. Browse to the following driver directory, then click **Next.**
`<ZDS installation>\device drivers\USB\`
5. After you find the appropriate driver, click **Next.**
6. Click **Finish** to complete the installation.

Windows 2000

Observe the following steps to install the USB Smart Cable for Windows 2000 systems.

1. Connect the Zilog USB device to the host PC. The **Found New Hardware** wizard should activate automatically after connecting the Zilog USB device for the first time.
2. After the **Found New Hardware** wizard has been activated, click **Next.**
3. Select **Search for a suitable driver for my device (Recommended),** then click **Next.**
4. Select **Specify a location** and click **Next.**
5. Browse to the following driver directory, then click **OK.**
`<ZDS installation>\device drivers\USB\`
6. After you find the appropriate driver, click **Next.**
7. Click **Finish** to complete the installation.

Connecting the USB Smart Cable

Observe the following steps to connect the USB Smart Cable to the ZMOTION Development Board.



Caution: The power to the development board must be disconnected or turned OFF before connecting or disconnecting the USB Smart Cable.

1. Attach one end of the six-conductor ribbon cable (included) to the USB Smart Cable six-pin DBG connector, as shown in Figure 4.

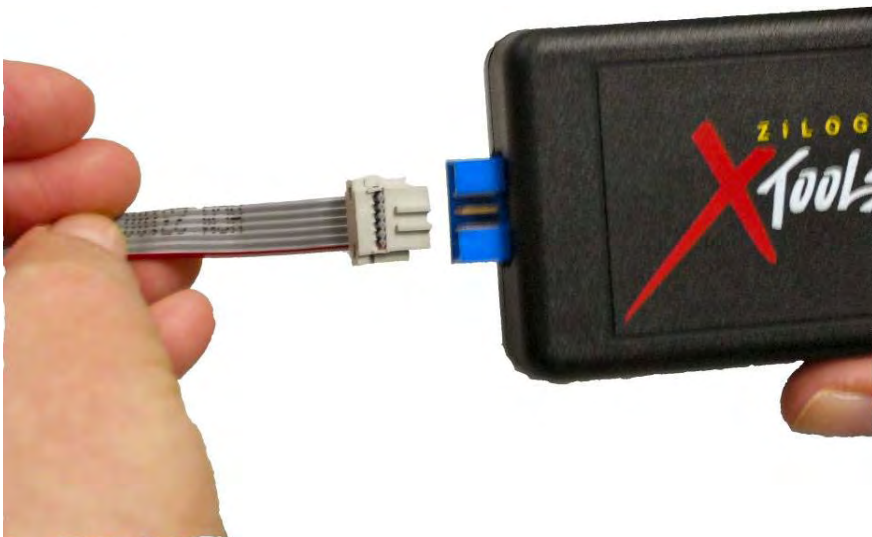

Figure 4. Connecting the Six-Conductor Ribbon Cable to the USB Smart Cable

2. Attach the free end of the ribbon cable to the DBG connector (ZDI Interface) on the development board. Ensure that pin 1 on the ribbon cable (indicated by the dark stripe) is aligned with pin 1 on the target connector (indicated by a 1 on P2 of the board).

Installing the FTDI USB to Serial Driver

Observe the following steps to install the FTDI USB to Serial Driver.

1. Make sure that the USB cable is not plugged into the ZMOTION Development Board.
2. On the CDROM, double-click the `CDM20802_Setup.exe` file to start the driver installation. The installation process will begin, and will appear similar to the following code statements:

```
32-bit OS detected
<installation path>\dpinstx86.exe
Installation driver
FTDI CDM driver installation process completed.
```

3. When the installation is complete, plug the USB cable into the ZMOTION Development Board.
4. If driver installation was successful, **USB Serial Port (COMx)** should appear in the list displayed in the Device Manager's **Ports (COM & LPT)** interface.

To open the Device Manager on Windows 7 systems, launch the Start menu, enter `Device Manager` in the **Search program and files** field, and press the Enter key.

To open the Device Manager on earlier Windows systems, navigate to the following filepath:

Start → Control Panel → System → Hardware → Device Manager → Ports (COM & LPT).

Downloading and Running the Sample Project

Sample projects are included on the Application CD. Copy these projects to a convenient folder on your PC. Once copied, ensure the folders are not

set to **Read Only** by right-clicking the folder and selecting properties. Deselect the **Read Only** attribute and click **OK**. Make sure you apply changes to this and the other subfolders when prompted.

In this example, we reference the ZMOTION_Intrusion_Demo project; however, the steps that follow will apply to any additional project.

► **Note:** At this point you should have loaded ZDSII and the Smart Cable USB driver on to your computer. If you haven't yet done so, revisit the beginning of this Installing ZDSII and the USB Smart Cable section before proceeding.

1. Open ZDSII and select **File** → **Open Project**, then navigate to the project folder labeled ZMOTION_Intrusion_Demo.
2. Open the ZMOTION_Intrusion_Demo.zdsproj project. When you first receive your kit, this project is already loaded into the ZMOTION MCU. Right-click within the open grey area below the menu icons and select **Workbook Mode** to turn on the tabs at the bottom of the editor and therefore make it easier to switch between files.
3. Click the **Rebuild All** icon to build the project. The build output should not indicate any errors. If you receive errors, try reloading the projects from the original Application CD and ensure that the folders are not set to **Read Only**. See Figure 5 for an example; Figure 6 indicates the location of the **Rebuild All** icon in the ZDSII menu bar.

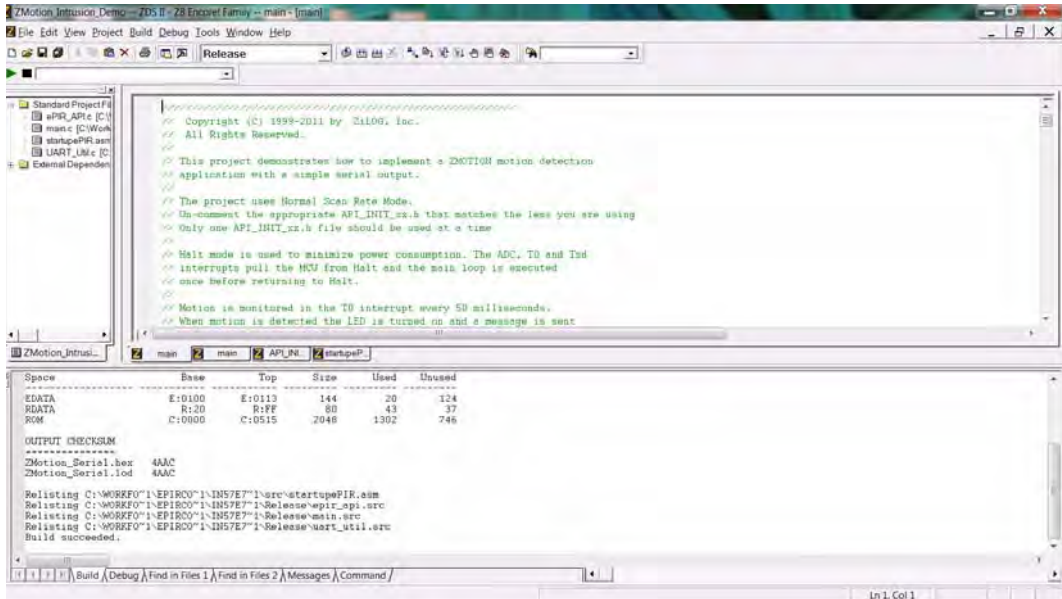

Figure 5. Building the ZMOTION_Intrusion_Demo project in ZDSII

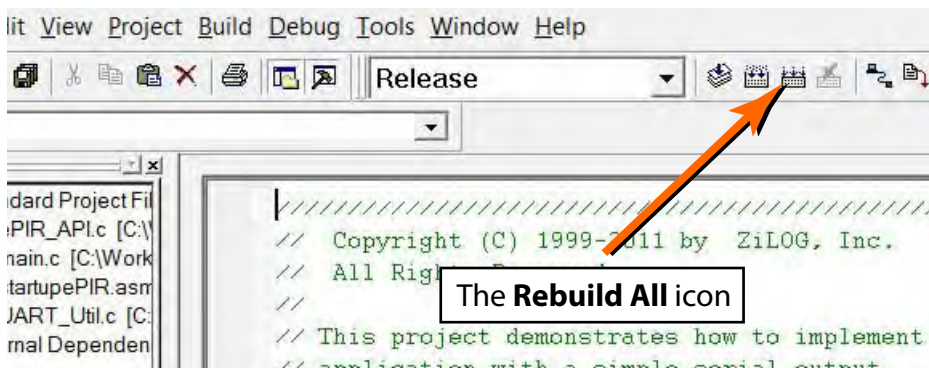

Figure 6. The Location of the Rebuild All Icon

4. Make sure that the ZMOTION Development Board is powered OFF, then connect the USB Smart Cable (Debugger) to P2, as described above.
5. Apply power to the Development Board by plugging in the USB cable and setting SW1 to the ON position. Next, click the **Reset** icon in ZDSII. Figure 7 indicates the location of both the **Reset** and **Go** icons in the ZDSII menu bar.

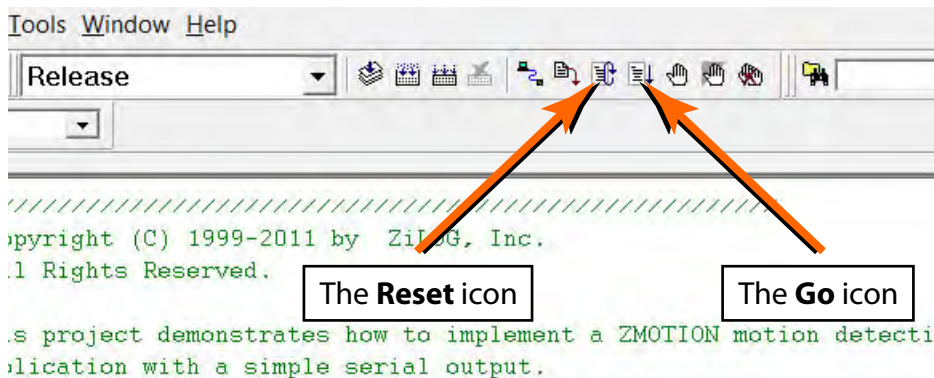

Figure 7. The Location of the Rest and Go Icons

6. An information notice may appear, indicating that the silicon is not the latest version. This occurrence is normal and is not an issue. Click **OK** to continue. You should see a message in the Debug Output Window indicating that the load was successful, as shown in Figure 8.

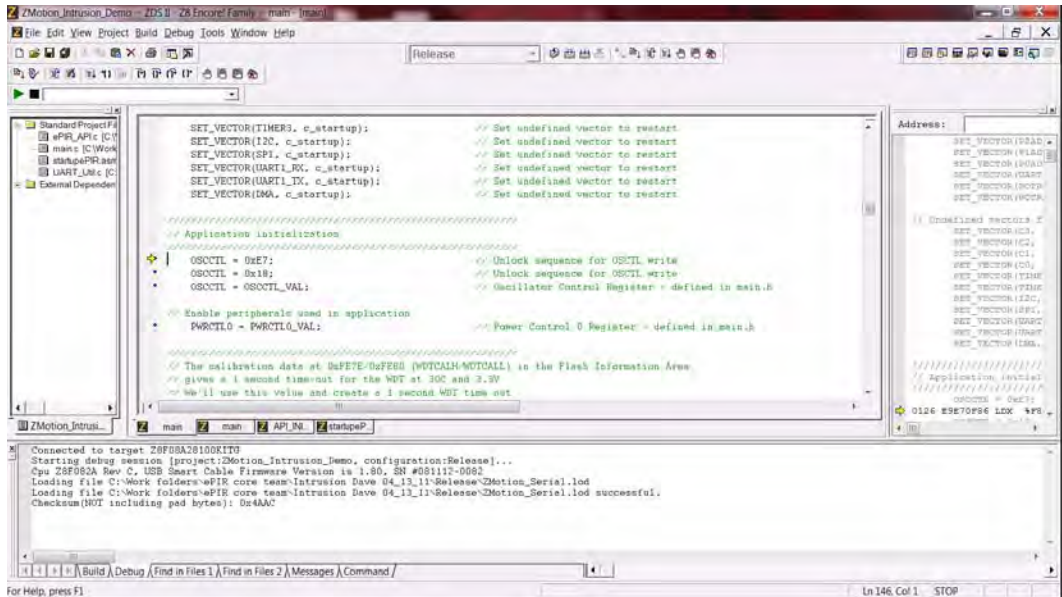

Figure 8. ZDSII's Debug Output Window for the ZMOTION_Basic project

7. Click the **Go** icon to start the application running. The Red LED (LED2) will be ON initially until the pyroelectric sensor stabilizes – a period that can take up to 30 seconds. After it has stabilized, (LED2) turns OFF, to turn ON only when motion is detected.
8. To test this procedure, wave your hand over the lens and notice (LED2) turning ON for approximately 1 second.

Making Changes to the ZMOTION_Intrusion_Demo Project

To change the duration of the LED on time, observe the following procedure.

1. Change the following line in the `main.c` file:

```
unsigned int cMDDelayTime = DELAY_1SEC;    // LED ON time
```

2. Change the line as follows to select a five-second LED on time:

```
unsigned int cMDDelayTime = DELAY_5SEC;    // LED ON time
```

► **Note:** LED on time definitions are provided in the `main.h` file for values from 200ms to 30 minutes.

3. Click the **Rebuild** icon to build the project. The build output should not indicate any errors. Click the **Go** icon to download the modified project and start the application running. Generate motion and notice that the LED now stays on for 5 seconds.
4. To change the lens used by the project, edit the `include` line at the top of the `main.c` file to include the appropriate `API_INIT` file. The project initially uses `API_INIT_09.h` to support the WA 1.2 GI 12 V4 (board clip-in) lens (see the code sample below). To use a different lens, edit out the comment characters (`//`) in the `main.c` file that correspond to the new lens, and comment out the lens that is no longer in use.

replace with:

```
// This file must match the lens and PIR sensor used in the application
// #include "API_INIT_00.h"           // Generic settings: non-lens-specific
// #include "API_INIT_01.h"           // API configuration file for AA 0.9 GI V1 Lens
// #include "API_INIT_02.h"           // API configuration file for CM 0.77 GI V3 Lens
```

```
##include "API_INIT_03.h" // API configuration file for CM 0.77 GI V5 Lens
##include "API_INIT_04.h" // API configuration file for CWM 0.5 GI V1 Lens
##include "API_INIT_05.h" // API configuration file for NCL-9(26) Lens
##include "API_INIT_06.h" // API configuration file for NCL-10IL Lens
##include "API_INIT_07.h" // API configuration file for NCL-3B Lens
##include "API_INIT_08.h" // API configuration file for NCL-11 Lens
#include "API_INIT_09.h" // API configuration file for WAL.2 GI 12 V4 Lens
##include "API_INIT_10.h" // API configuration file for LRL.2 GI 12 V3 Lens
##include "API_INIT_11.h" // API configuration file for VB1.2 GI V1 Lens
```

The `API_INIT` file must match the lens and pyroelectric sensor being used on the Development Board. Use the Lens Selection Guide in the ZMOTION Lens and Pyroelectric Sensor Product Specification (PS0286) to determine which `API_INT` file is required for each lens and Pyroelectric Sensor combination.

Board Design Information

Figure 9 displays the schematics for the ZMOTION Development Board.

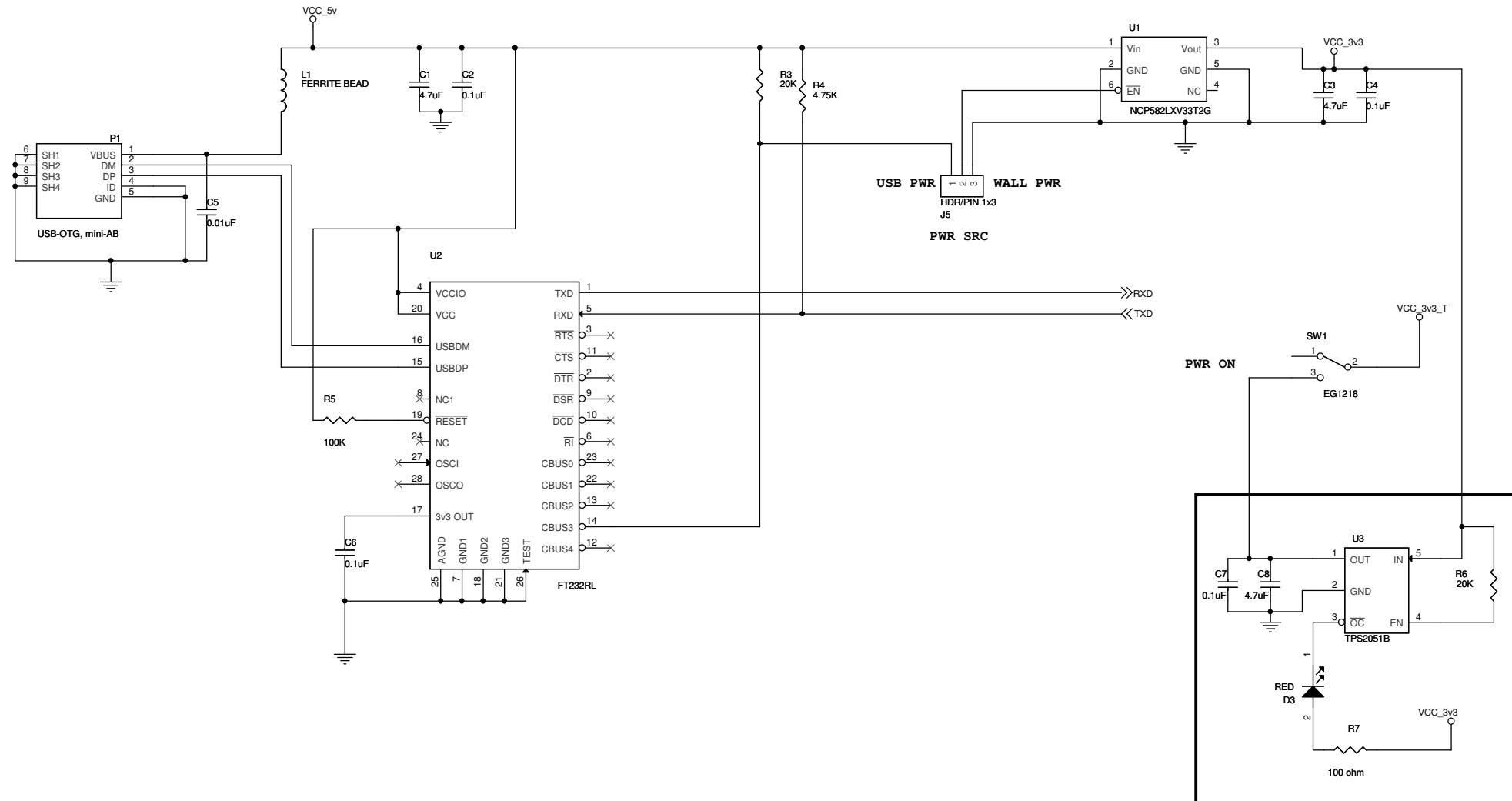

Figure 9. ZMOTION Development Board Schematic Diagram, #1 of 2

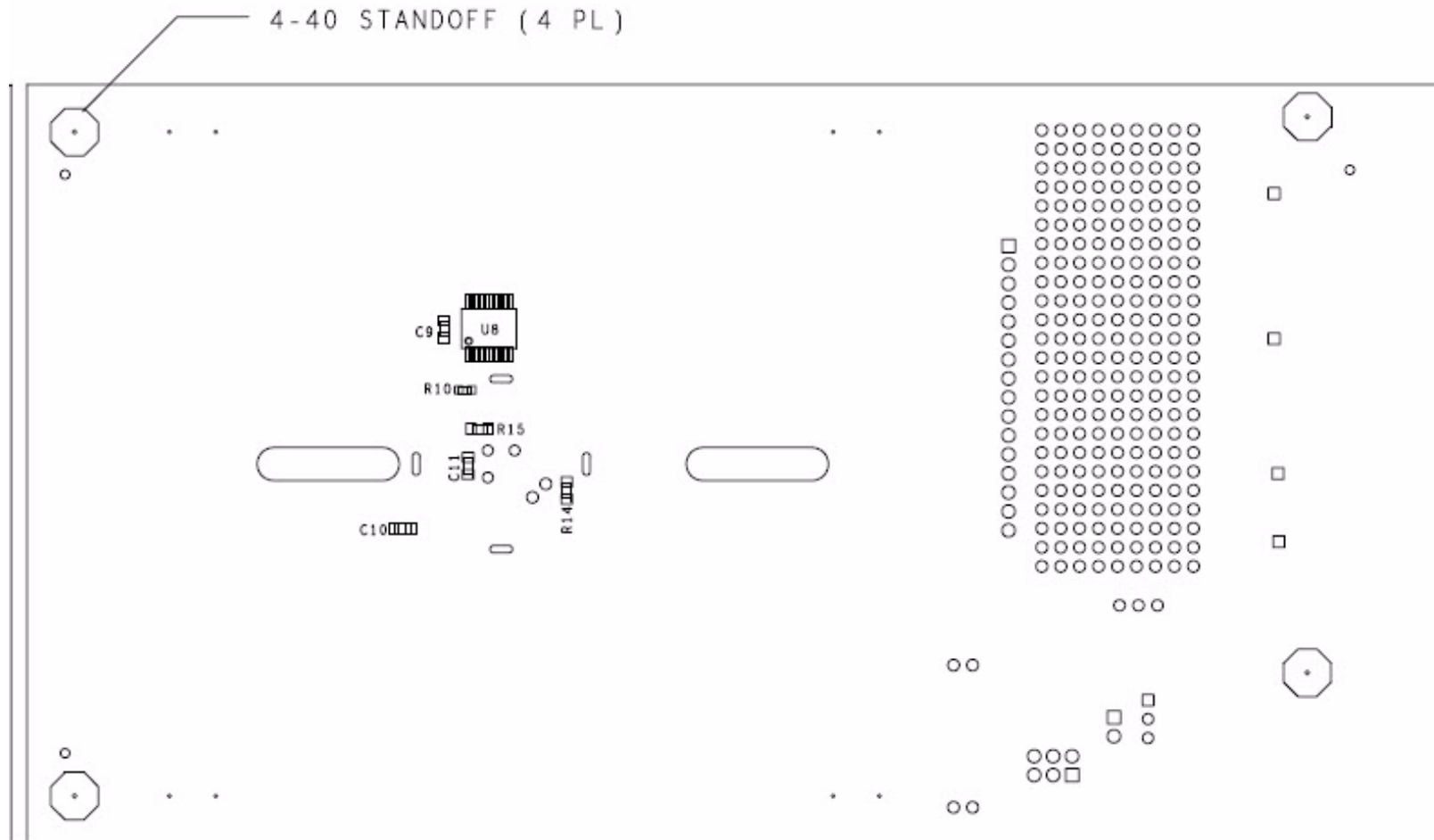

Figure 12. ZMOTION Development Board Mechanical Diagram, Bottom View

Customer Support

To share comments, get your technical questions answered, or report issues you may be experiencing with our products, please visit Zilog's Technical Support page at <http://support.zilog.com>.

To learn more about this product, find additional documentation, or to discover other facets about Zilog product offerings, please visit the Zilog Knowledge Base at <http://zilog.com/kb> or consider participating in the Zilog Forum at <http://zilog.com/forum>.

This publication is subject to replacement by a later edition. To determine whether a later edition exists, please visit the Zilog website at <http://www.zilog.com>.