

PACKAGE TOP VIEW

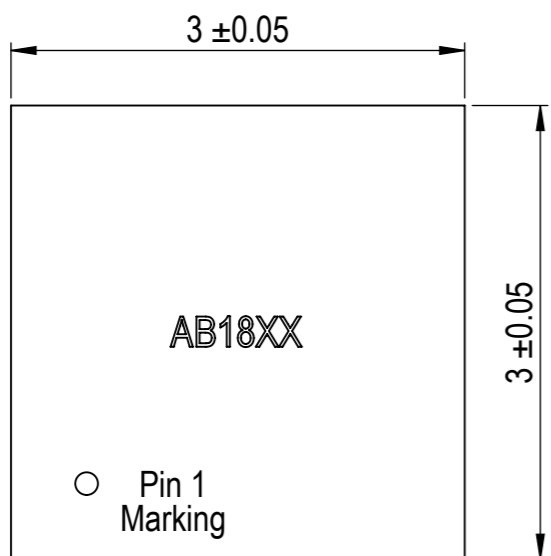

EXAMPLE PCB LAND PATTERN

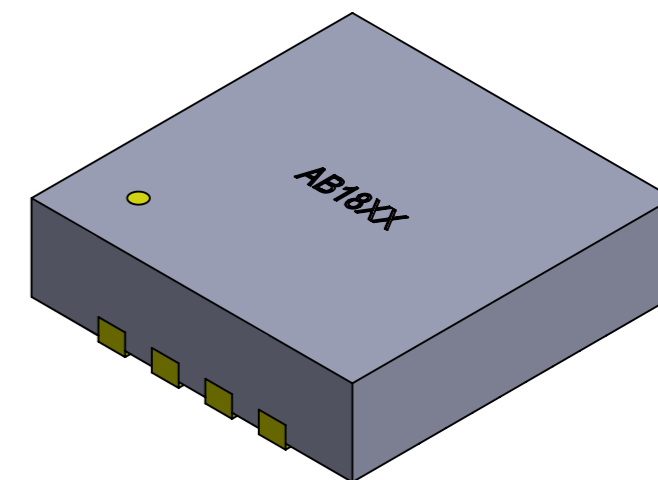
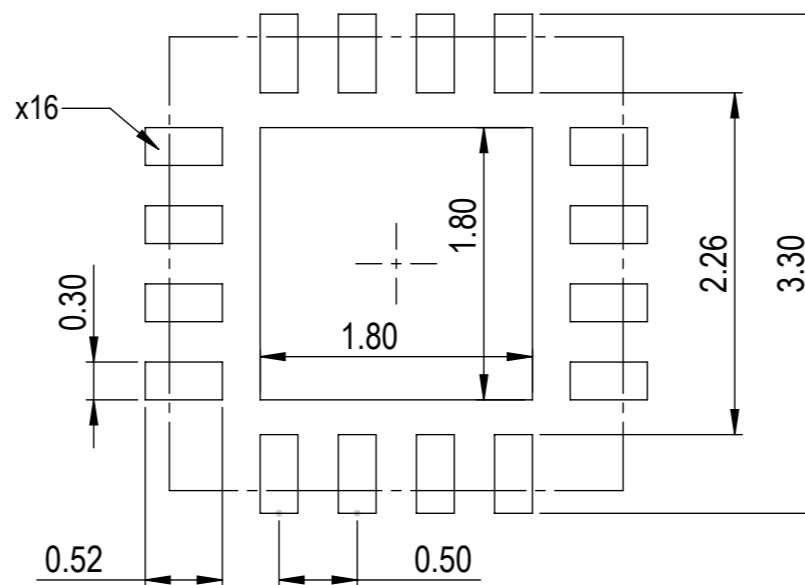

PACKAGE SIDE VIEW

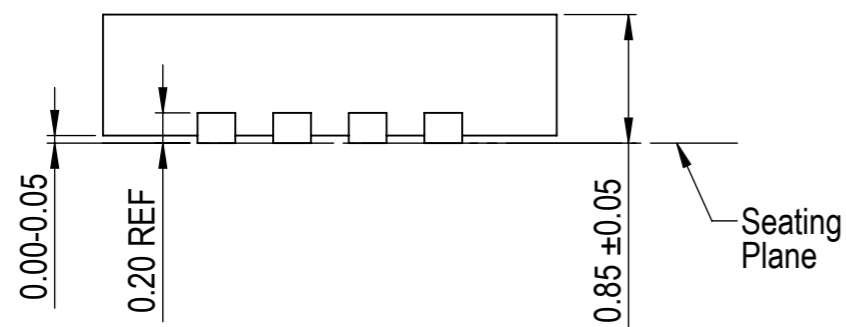

EXAMPLE SOLDER STENCIL

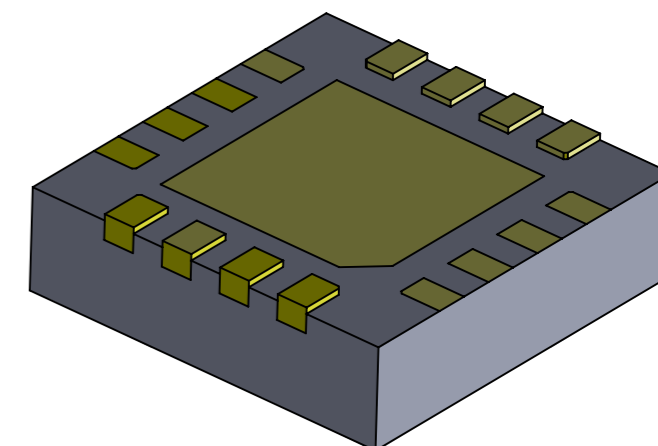
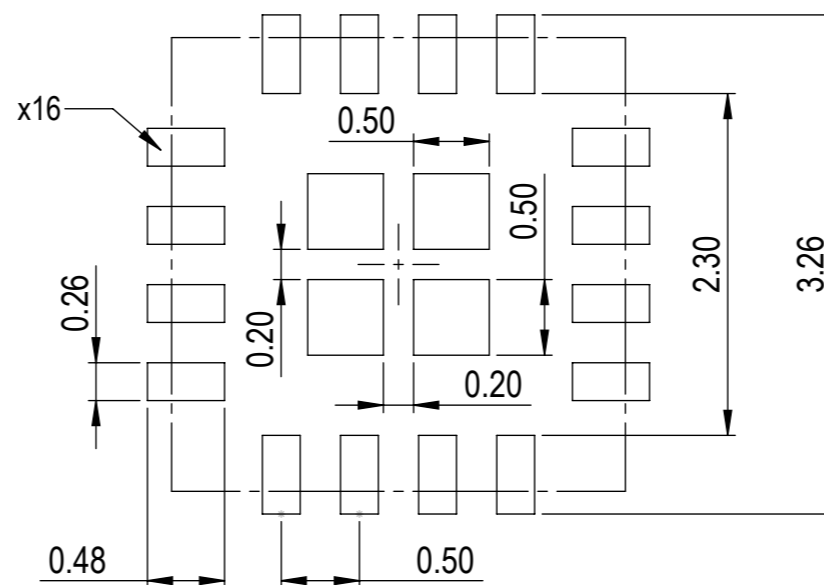

PACKAGE BOTTOM VIEW

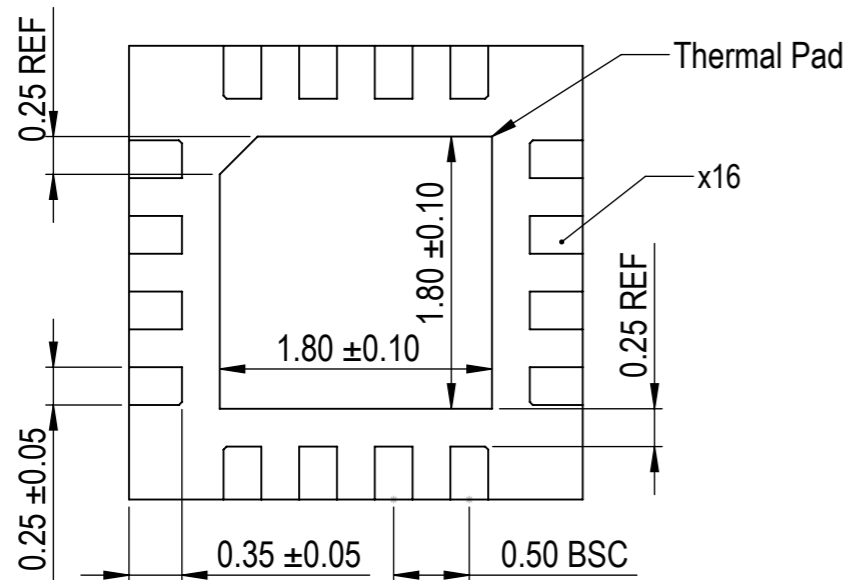

UNLESS OTHERWISE SPECIFIED: DIMENSIONS ARE IN MM SURFACE FINISH: TOLERANCES: LINEAR: ANGULAR:				FINISH:		DEBUR AND BREAK SHARP EDGES		DO NOT SCALE DRAWING		REVISION	
DRAWN				NAME		SIGNATURE		DATE		-	
CHK'D				XXXXXX						30332 Esperanza, Rancho Santa margarita, California 92688	
APPV'D				XXXXXX						TITLE: AB18XX Series Ultra Low Power RTC IC; User's Guide	
MFG										DWG NO. AB18XX	
Q.A								MATERIAL:		A3	
								WEIGHT:		SCALE:20:1	
										SHEET 1 OF 1	