

END OF LIFE

PD - 96115B

International
IR Rectifier

IRF9952QPbF

HEXFET® Power MOSFET

- Advanced Process Technology
- Ultra Low On-Resistance
- Dual N and P Channel MOSFET
- Surface Mount
- Available in Tape & Reel
- 150°C Operating Temperature
- Lead-Free

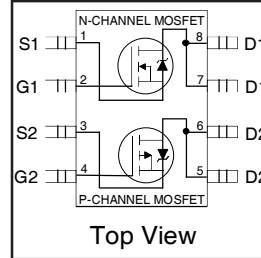

	N-Ch	P-Ch
V_{DS}	30V	-30V
$R_{DS(on)}$	0.10Ω	0.25Ω

Description

These HEXFET® Power MOSFET's in a Dual SO-8 package utilize the latest processing techniques to achieve extremely low on-resistance per silicon area. Additional features of these HEXFET Power MOSFET's are a 150°C junction operating temperature, fast switching speed and improved repetitive avalanche rating. These benefits combine to make this design an extremely efficient and reliable device for use in a wide variety of applications. The efficient SO-8 package provides enhanced thermal characteristics and dual MOSFET die capability making it ideal in a variety of power applications. This dual, surface mount SO-8 can dramatically reduce board space and is also available in Tape & Reel.

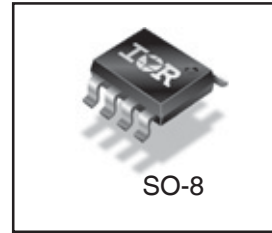

Base part number	Orderable part number	Package Type	Standard Pack		EOL Notice	Replacement Part Number
			Form	Quantity		
IRF9952QPbF	IRF9952QTRPbF	SO-8	Tape and Reel	4000	EOL 529	Please search the EOL part number on IR's website for guidance
	IRF9952QPbF	SO-8	Tube	95	EOL 529	

	Symbol	Maximum		Units	
		N-Channel	P-Channel		
Drain-Source Voltage	V_{DS}	30		V	
Gate-Source Voltage	V_{GS}	± 20			
Continuous Drain Current ^⑤	I_D	$T_A = 25^\circ\text{C}$	3.5	-2.3	A
		$T_A = 70^\circ\text{C}$	2.8	-1.8	
Pulsed Drain Current	I_{DM}	16	-10		
Continuous Source Current (Diode Conduction)	I_S	1.7	-1.3		
Maximum Power Dissipation ^⑤	P_D	$T_A = 25^\circ\text{C}$	2.0		W
		$T_A = 70^\circ\text{C}$	1.3		
Single Pulse Avalanche Energy	E_{AS}	44	57	mJ	
Avalanche Current	I_{AR}	2.0	-1.3	A	
Repetitive Avalanche Energy	E_{AR}	0.25		mJ	
Peak Diode Recovery dv/dt ^②	dv/dt	5.0	-5.0	V/ ns	
Junction and Storage Temperature Range	T_J, T_{STG}	-55 to + 150		°C	

Thermal Resistance Ratings

Parameter	Symbol	Limit	Units
Maximum Junction-to-Ambient ^⑤	$R_{\theta JA}$	62.5	°C/W

END OF LIFE

IRF9952QPbF

International
IR Rectifier

Electrical Characteristics @ T_J = 25°C (unless otherwise specified)

Parameter	Min.	Typ.	Max.	Units	Conditions
V _{(BR)DSS}	N-Ch 30 P-Ch -30	—	—	—	V V _{GS} = 0V, I _D = 250μA V _{GS} = 0V, I _D = -250μA
ΔV _{(BR)DSS} /ΔT _J	N-Ch — P-Ch —	0.015 0.015	—	—	V/°C Reference to 25°C, I _D = 1mA Reference to 25°C, I _D = -1mA
R _{DS(ON)}	N-Ch — P-Ch —	0.08 0.12	0.10 0.15	—	Ω V _{GS} = 10V, I _D = 2.2A ④ V _{GS} = 4.5V, I _D = 1.0A ④ V _{GS} = -10V, I _D = -1.0A ④ V _{GS} = -4.5V, I _D = -0.50A ④
V _{GS(th)}	N-Ch 1.0 P-Ch -1.0	—	—	—	V V _{DS} = V _{GS} , I _D = 250μA V _{DS} = V _{GS} , I _D = -250μA
g _{fs}	N-Ch — P-Ch —	12 2.4	—	—	S V _{DS} = 15V, I _D = 3.5A ④ V _{DS} = -15V, I _D = -2.3A ④
I _{DSS}	N-Ch — P-Ch —	—	2.0 -2.0	—	μA V _{DS} = 24V, V _{GS} = 0V V _{DS} = -24V, V _{GS} = 0V
I _{GSS}	N-Ch — P-Ch —	—	25 -25	—	μA V _{DS} = 24V, V _{GS} = 0V, T _J = 125°C V _{DS} = -24V, V _{GS} = 0V, T _J = 125°C
I _{GSS}	N-P —	—	±100	nA	V _{GS} = ±20V
Q _g	N-Ch — P-Ch —	6.9 6.1	14 12	—	nC N-Channel I _D = 1.8A, V _{DS} = 10V, V _{GS} = 10V ④
Q _{gs}	N-Ch — P-Ch —	1.0 1.7	2.0 3.4	—	nC P-Channel I _D = -2.3A, V _{DS} = -10V, V _{GS} = -10V ④
Q _{gd}	N-Ch — P-Ch —	1.8 1.1	3.5 2.2	—	nC N-Channel V _{DD} = 10V, I _D = 1.0A, R _G = 6.0Ω, R _D = 10Ω ④
t _{d(on)}	N-Ch — P-Ch —	6.2 9.7	12 19	—	ns P-Channel V _{DD} = -10V, I _D = -1.0A, R _G = 6.0Ω, R _D = 10Ω ④
t _r	N-Ch — P-Ch —	8.8 14	18 28	—	ns N-Channel V _{GS} = 0V, V _{DS} = 15V, f = 1.0MHz
t _{d(off)}	N-Ch — P-Ch —	13 20	26 40	—	ns P-Channel V _{GS} = 0V, V _{DS} = -15V, f = 1.0MHz
t _f	N-Ch — P-Ch —	3.0 6.9	6.0 14	—	ns N-Channel V _{GS} = 0V, V _{DS} = -15V, f = 1.0MHz
C _{iss}	N-Ch — P-Ch —	190 190	—	—	pF P-Channel V _{GS} = 0V, V _{DS} = -15V, f = 1.0MHz
C _{oss}	N-Ch — P-Ch —	120 110	—	—	pF
C _{rss}	N-Ch — P-Ch —	61 54	—	—	pF

Source-Drain Ratings and Characteristics

Parameter	Min.	Typ.	Max.	Units	Conditions
I _S	N-Ch — P-Ch —	—	1.7 -1.3	A	A
I _{SM}	N-Ch — P-Ch —	—	16 16	A	
V _{SD}	N-Ch — P-Ch —	0.82 -0.82	1.2 -1.2	V	T _J = 25°C, I _S = 1.25A, V _{GS} = 0V ③ T _J = 25°C, I _S = -1.25A, V _{GS} = 0V ③
t _{rr}	N-Ch — P-Ch —	27 27	53 54	ns	N-Channel T _J = 25°C, I _F = 1.25A, di/dt = 100A/μs P-Channel
Q _{rr}	N-Ch — P-Ch —	28 31	57 62	nC	T _J = 25°C, I _F = -1.25A, di/dt = 100A/μs ④

Notes:

- ① Repetitive rating; pulse width limited by max. junction temperature. (See fig. 23)
- ② N-Channel I_{SD} ≤ 2.0A, di/dt ≤ 100A/μs, V_{DD} ≤ V_{(BR)DSS}, T_J ≤ 150°C
P-Channel I_{SD} ≤ -1.3A, di/dt ≤ 84A/μs, V_{DD} ≤ V_{(BR)DSS}, T_J ≤ 150°C
- ③ N-Channel Starting T_J = 25°C, L = 22mH R_G = 25Ω, I_{AS} = 2.0A. (See Figure 12)
P-Channel Starting T_J = 25°C, L = 67mH R_G = 25Ω, I_{AS} = -1.3A.
- ④ Pulse width ≤ 300μs; duty cycle ≤ 2%.
- ⑤ Surface mounted on FR-4 board, t ≤ 10sec.

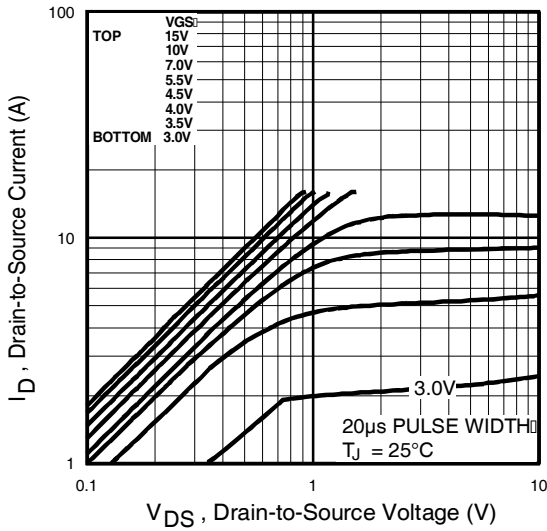

Fig 1. Typical Output Characteristics

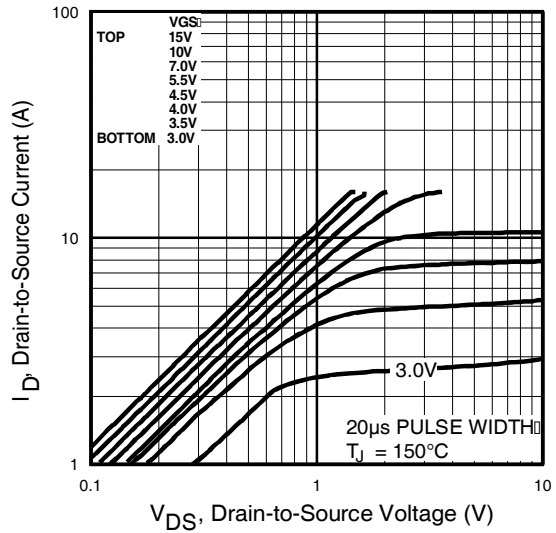

Fig 2. Typical Output Characteristics

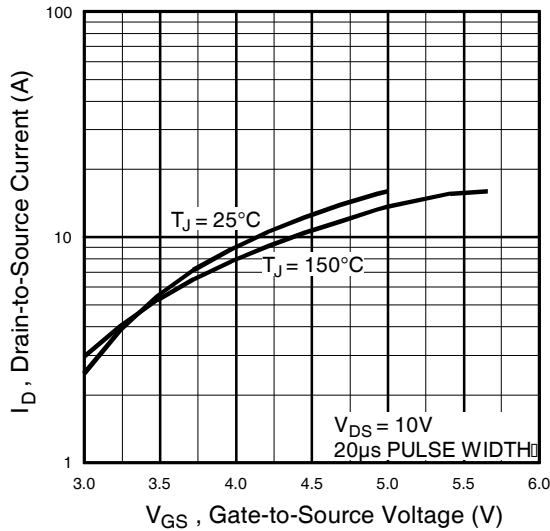

Fig 3. Typical Transfer Characteristics

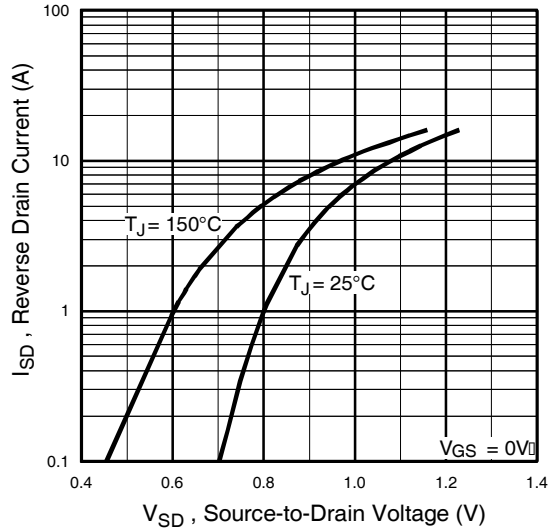

Fig 4. Typical Source-Drain Diode Forward Voltage

END OF LIFE

IRF9952QPbF

N-Channel

International
IR Rectifier

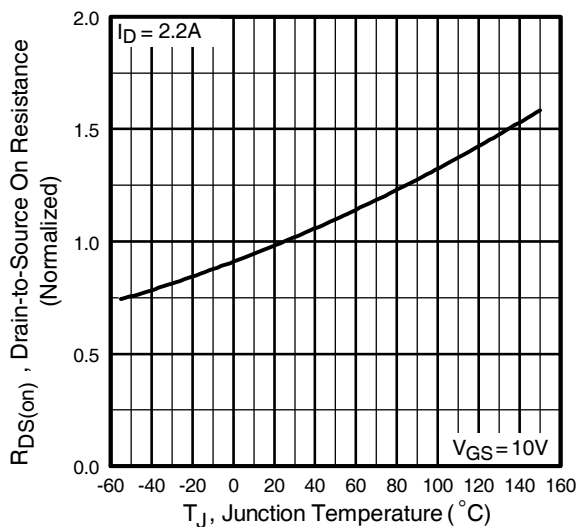

Fig 5. Normalized On-Resistance Vs. Temperature

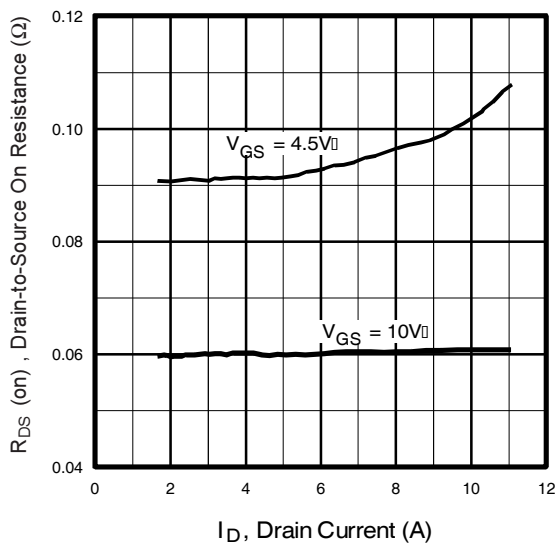

Fig 6. Typical On-Resistance Vs. Drain Current

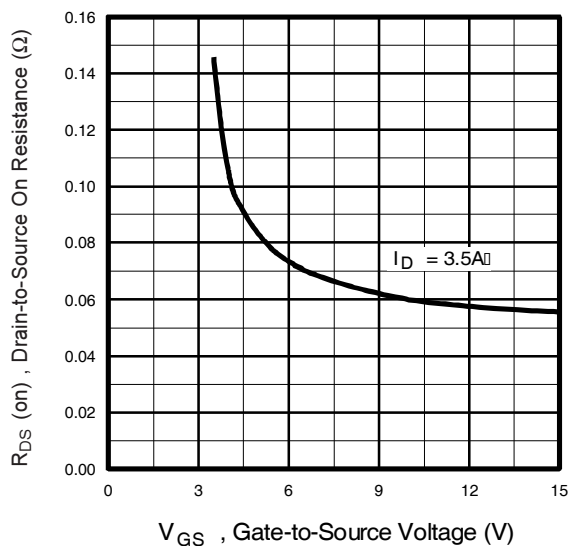

Fig 7. Typical On-Resistance Vs. Gate Voltage

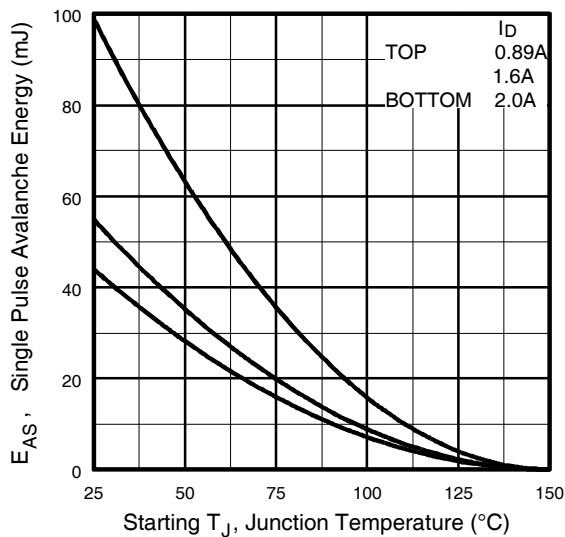

Fig 8. Maximum Avalanche Energy Vs. Drain Current

END OF LIFE

International
IR Rectifier

N-Channel

IRF9952QPbF

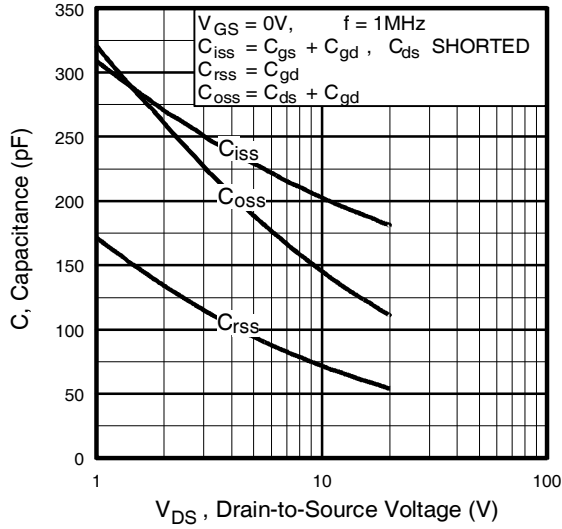

Fig 9. Typical Capacitance Vs. Drain-to-Source Voltage

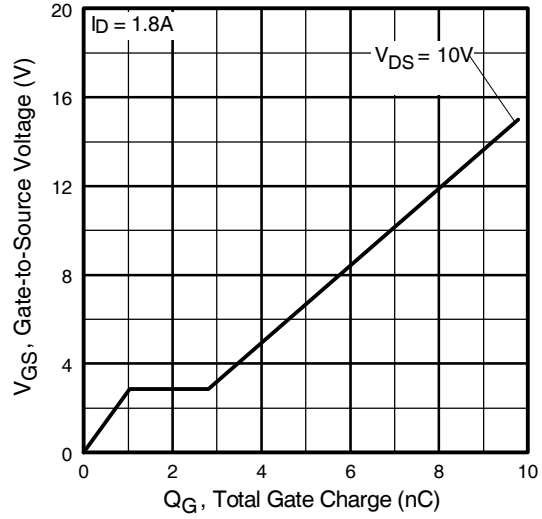

Fig 10. Typical Gate Charge Vs. Gate-to-Source Voltage

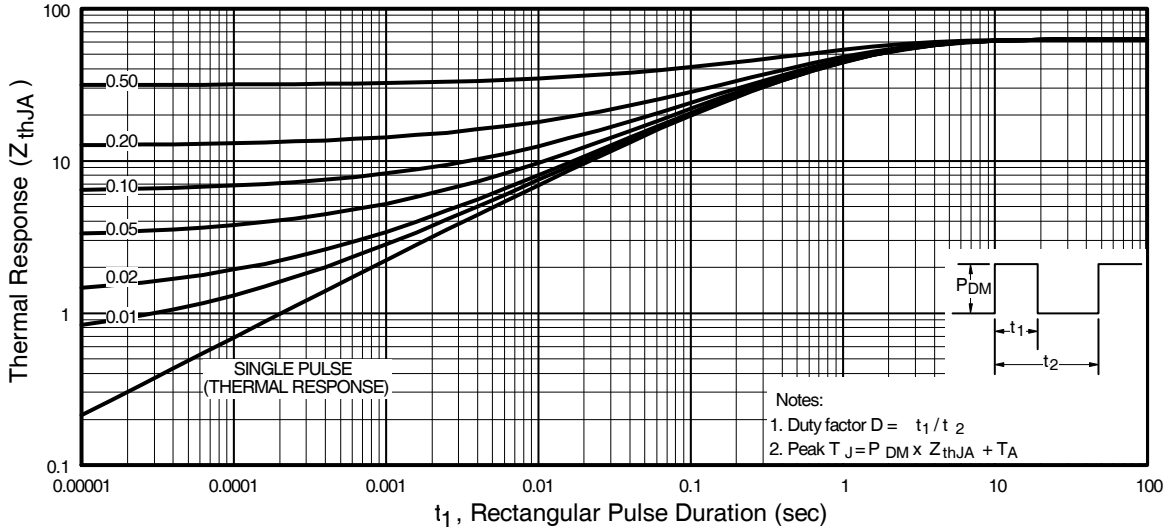

Fig 11. Maximum Effective Transient Thermal Impedance, Junction-to-Ambient

END OF LIFE

IRF9952QPbF

P-Channel

International
IR Rectifier

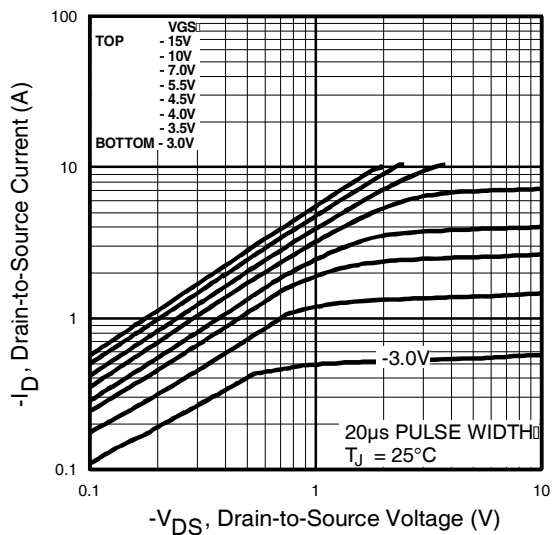

Fig 12. Typical Output Characteristics

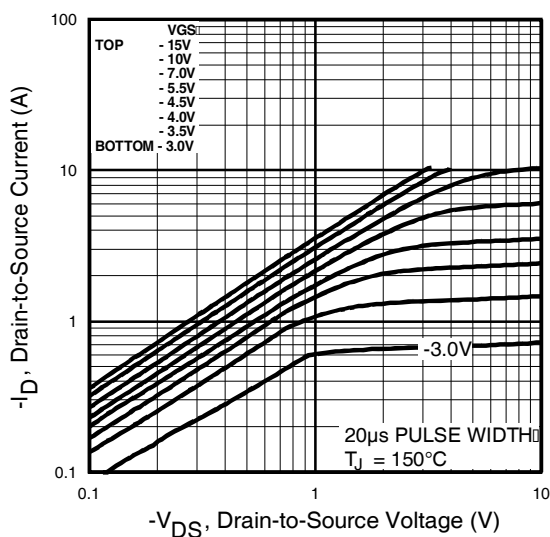

Fig 13. Typical Output Characteristics

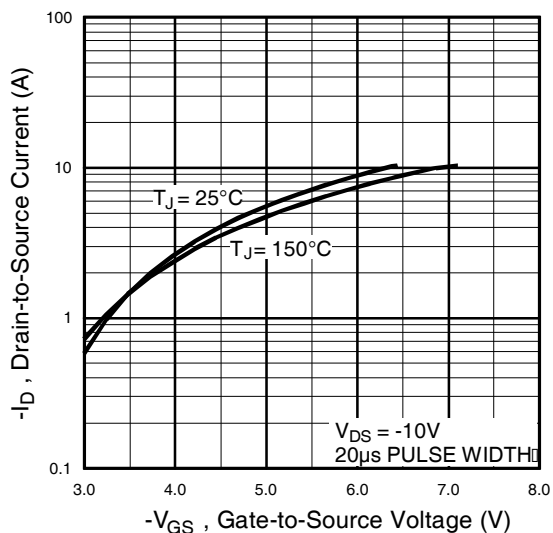

Fig 14. Typical Transfer Characteristics

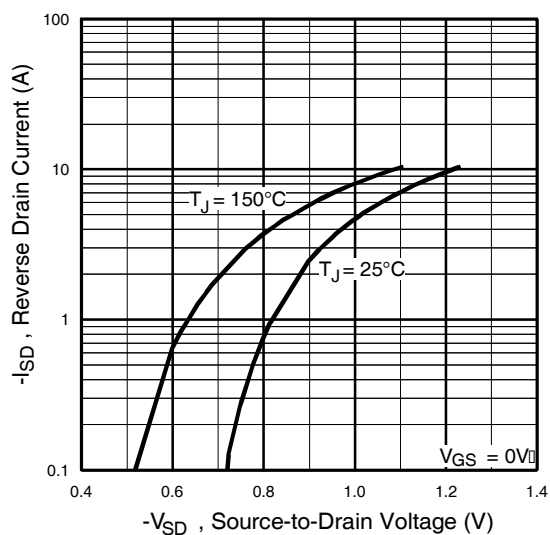

Fig 15. Typical Source-Drain Diode Forward Voltage

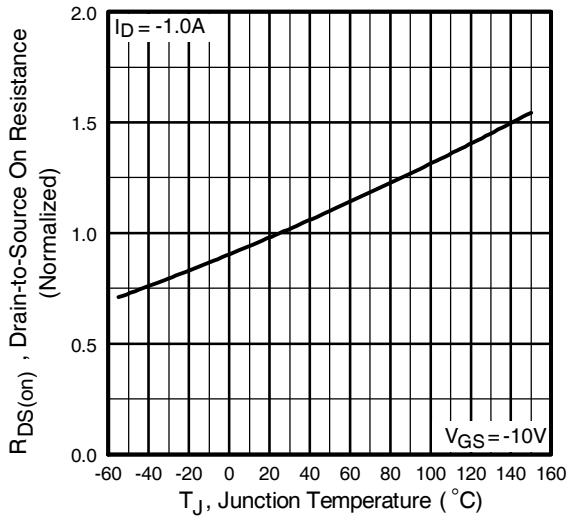

Fig 16. Normalized On-Resistance Vs. Temperature

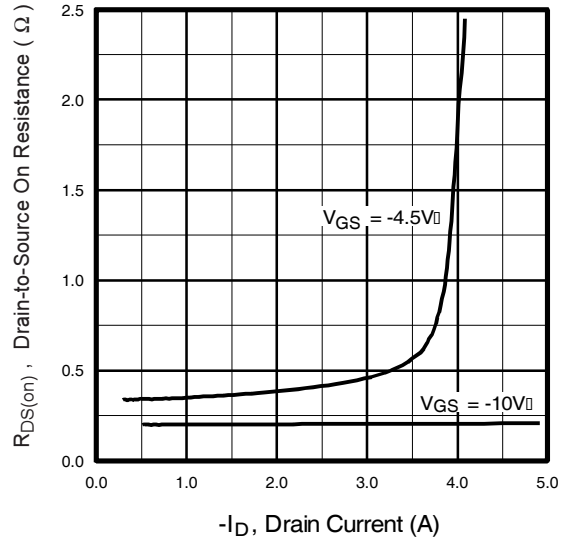

Fig 17. Typical On-Resistance Vs. Drain Current

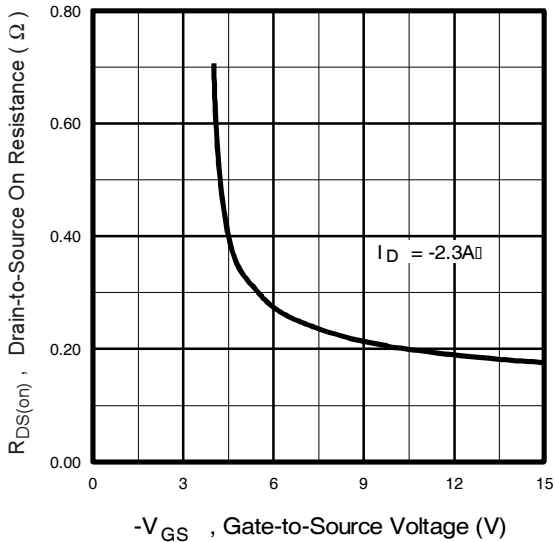

Fig 18. Typical On-Resistance Vs. Gate Voltage

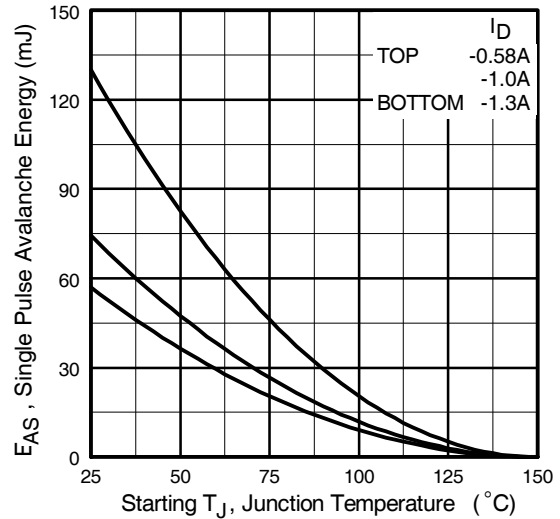

Fig 19. Maximum Avalanche Energy Vs. Drain Current

END OF LIFE

IRF9952QPbF

P-Channel

International
IR Rectifier

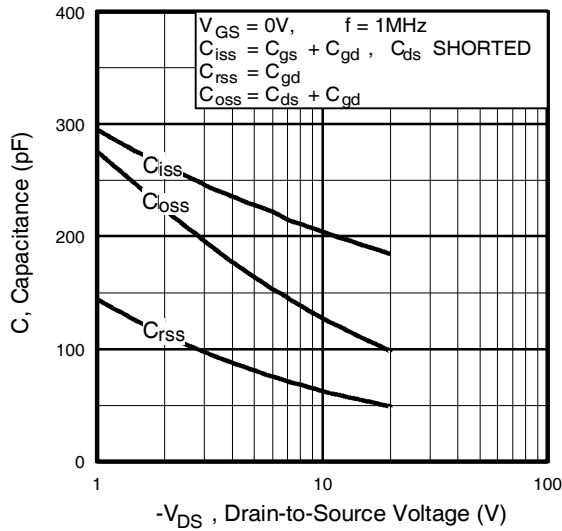

Fig 20. Typical Capacitance Vs. Drain-to-Source Voltage

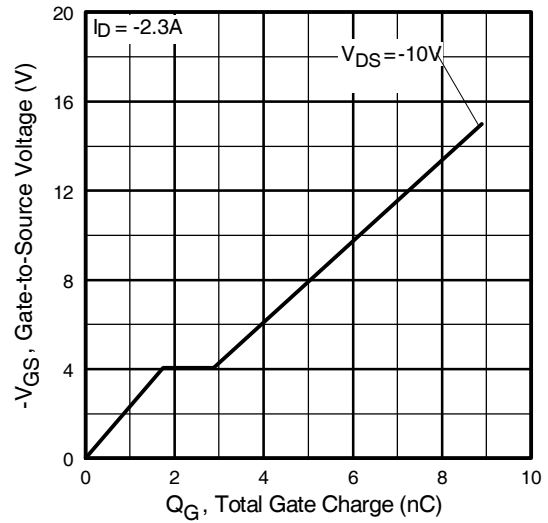

Fig 21. Typical Gate Charge Vs. Gate-to-Source Voltage

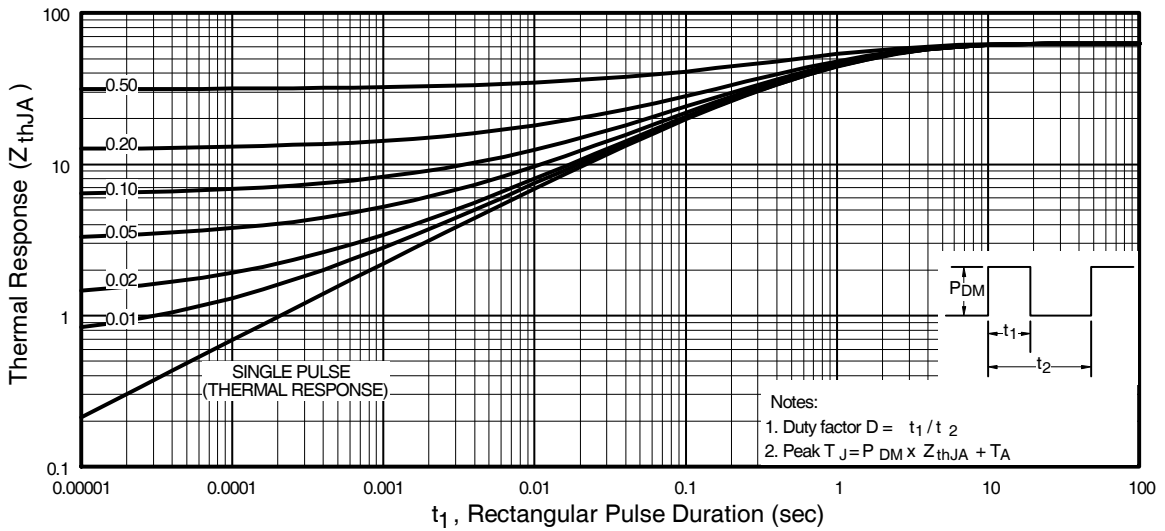

Fig 22. Maximum Effective Transient Thermal Impedance, Junction-to-Ambient

END OF LIFE

International
IR Rectifier

IRF9952QPbF

SO-8 Package Outline

Dimensions are shown in millimeters (inches)

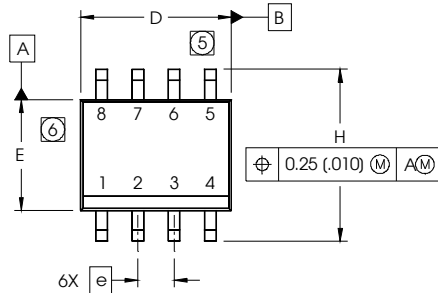

DIM	INCHES		MILLIMETERS	
	MIN	MAX	MIN	MAX
A	.0532	.0688	1.35	1.75
A1	.0040	.0098	0.10	0.25
b	.013	.020	0.33	0.51
c	.0075	.0098	0.19	0.25
D	.189	.1968	4.80	5.00
E	.1497	.1574	3.80	4.00
e	.050 BASIC		1.27 BASIC	
e1	.025 BASIC		0.635 BASIC	
H	.2284	.2440	5.80	6.20
K	.0099	.0196	0.25	0.50
L	.016	.050	0.40	1.27
y	0°	8°	0°	8°

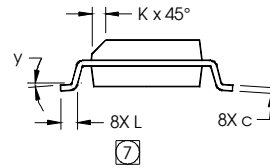
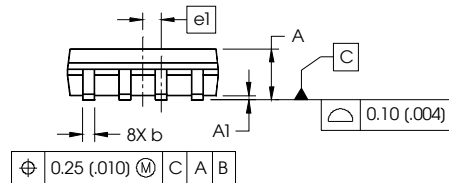

NOTES:

1. DIMENSIONING & TOLERANCING PER ASME Y14.5M-1994.
2. CONTROLLING DIMENSION: MILLIMETER
3. DIMENSIONS ARE SHOWN IN MILLIMETERS (INCHES).
4. OUTLINE CONFORMS TO JEDEC OUTLINE MS-012AA.
- ⑤ DIMENSION DOES NOT INCLUDE MOLD PROTRUSIONS. MOLD PROTRUSIONS NOT TO EXCEED 0.15 (.006).
- ⑥ DIMENSION DOES NOT INCLUDE MOLD PROTRUSIONS. MOLD PROTRUSIONS NOT TO EXCEED 0.25 (.010).
- ⑦ DIMENSION IS THE LENGTH OF LEAD FOR SOLDERING TO A SUBSTRATE.

FOOTPRINT

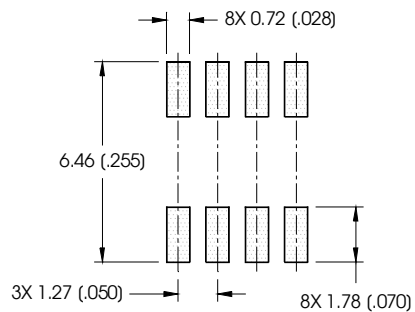

SO-8 Part Marking

EXAMPLE: THIS IS AN IRF7101 (MOSFET)

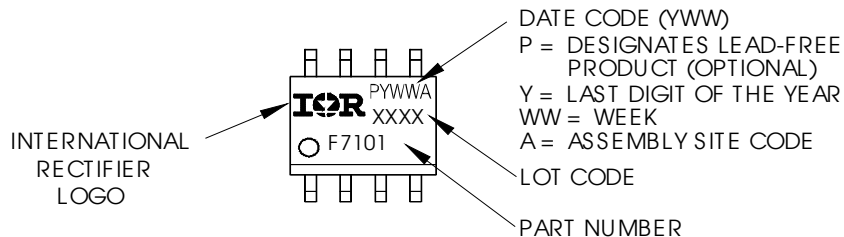

Notes:

1. For an Automotive Qualified version of this part please see: <http://www.irf.com/product-info/autos>
2. For the most current drawing please refer to IR website at <http://www.irf.com/package/>

END OF LIFE

IRF9952QPbF

International
IR Rectifier

SO-8 Tape and Reel

Dimensions are shown in millimeters (inches)

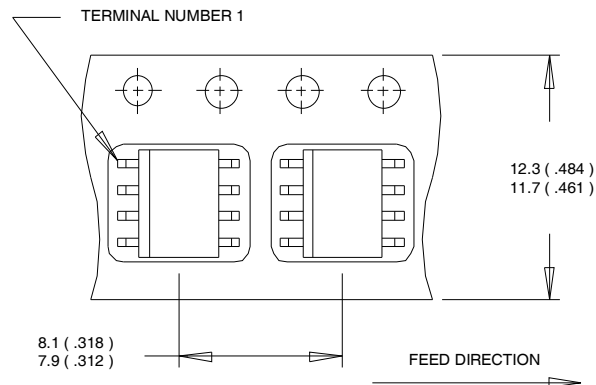

NOTES:

1. CONTROLLING DIMENSION : MILLIMETER.
2. ALL DIMENSIONS ARE SHOWN IN MILLIMETERS(INCHES).
3. OUTLINE CONFORMS TO EIA-481 & EIA-541.

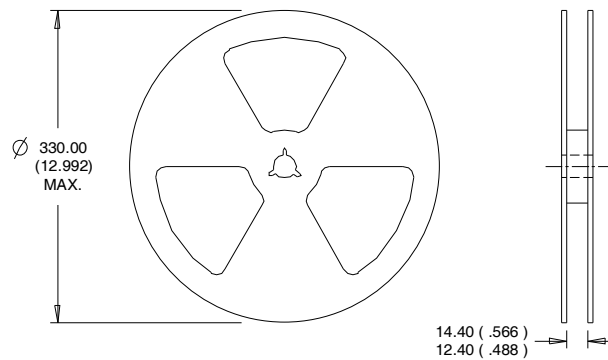

NOTES :

1. CONTROLLING DIMENSION : MILLIMETER.
2. OUTLINE CONFORMS TO EIA-481 & EIA-541.

For the most current drawing please refer to IR website at <http://www.irf.com/package/>

END OF LIFE

International
IR Rectifier

IRF9952QPbF

Qualification Information[†]

Qualification level	Industrial [†]	
	(per JEDEC JESD47F ^{††} guidelines)	
Moisture Sensitivity Level	SO-8	MSL1 (per JEDEC J-STD-020D ^{††})
RoHS Compliant	Yes	

† Qualification standards can be found at International Rectifier's web site
<http://www.irf.com/product-info/reliability>

†† Applicable version of JEDEC standard at the time of product release.

Revision History

Date	Comments
10/3/2014	• Added ordering information to reflect the End-Of-life

International
IR Rectifier

IR WORLD HEADQUARTERS: 101 N. Sepulveda Blvd., El Segundo, California 90245, USA
To contact International Rectifier, please visit <http://www.irf.com/whoto-call/>