

# Thyristor Module

 $V_{RRM} = 2 \times 1800 \text{ V}$ 
 $I_{TAV} = 49 \text{ A}$ 
 $V_T = 1.34 \text{ V}$ 

Phase leg

Part number

**MCC44-18io8B**



Backside: isolated

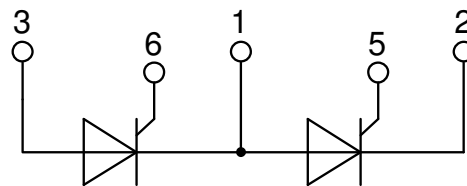

### Features / Advantages:

- Thyristor for line frequency
- Planar passivated chip
- Long-term stability
- Direct Copper Bonded Al<sub>2</sub>O<sub>3</sub>-ceramic

### Applications:

- Line rectifying 50/60 Hz
- Softstart AC motor control
- DC Motor control
- Power converter
- AC power control
- Lighting and temperature control

### Package: TO-240AA

- Isolation Voltage: 3600 V~
- Industry standard outline
- RoHS compliant
- Soldering pins for PCB mounting
- Base plate: DCB ceramic
- Reduced weight
- Advanced power cycling

### Terms .Conditions of usage:

The data contained in this product data sheet is exclusively intended for technically trained staff. The user will have to evaluate the suitability of the product for the intended application and the completeness of the product data with respect to his application. The specifications of our components may not be considered as an assurance of component characteristics. The information in the valid application- and assembly notes must be considered. Should you require product information in excess of the data given in this product data sheet or which concerns the specific application of your product, please contact your local sales office.

Due to technical requirements our product may contain dangerous substances. For information on the types in question please contact your local sales office.

Should you intend to use the product in aviation, in health or life endangering or life support applications, please notify. For any such application we urgently recommend

- to perform joint risk and quality assessments;

- the conclusion of quality agreements;

- to establish joint measures of an ongoing product survey, and that we may make delivery dependent on the realization of any such measures.

Thyristor			Ratings				
Symbol	Definition	Conditions	min.	typ.	max.	Unit	
$V_{RSM/DSM}$	max. non-repetitive reverse/forward blocking voltage	$T_{VJ} = 25^{\circ}C$			1900	V	
$V_{RRM/DRM}$	max. repetitive reverse/forward blocking voltage	$T_{VJ} = 25^{\circ}C$			1800	V	
$I_{RD}$	reverse current, drain current	$V_{R/D} = 1800\text{ V}$	$T_{VJ} = 25^{\circ}C$		100	$\mu A$	
		$V_{R/D} = 1800\text{ V}$	$T_{VJ} = 125^{\circ}C$		5	mA	
$V_T$	forward voltage drop	$I_T = 100\text{ A}$	$T_{VJ} = 25^{\circ}C$		1.34	V	
		$I_T = 200\text{ A}$			1.75	V	
		$I_T = 100\text{ A}$	$T_{VJ} = 125^{\circ}C$			1.34	V
		$I_T = 200\text{ A}$				1.80	V
$I_{TAV}$	average forward current	$T_C = 85^{\circ}C$	$T_{VJ} = 125^{\circ}C$		49	A	
$I_{T(RMS)}$	RMS forward current	180° sine			77	A	
$V_{T0}$	threshold voltage	} for power loss calculation only	$T_{VJ} = 125^{\circ}C$		0.85	V	
$r_T$	slope resistance				3.7	m $\Omega$	
$R_{thJC}$	thermal resistance junction to case				0.53	K/W	
$R_{thCH}$	thermal resistance case to heatsink			0.20		K/W	
$P_{tot}$	total power dissipation		$T_C = 25^{\circ}C$		180	W	
$I_{TSM}$	max. forward surge current	$t = 10\text{ ms}; (50\text{ Hz}), \text{ sine}$	$T_{VJ} = 45^{\circ}C$		1.15	kA	
		$t = 8,3\text{ ms}; (60\text{ Hz}), \text{ sine}$	$V_R = 0\text{ V}$		1.24	kA	
		$t = 10\text{ ms}; (50\text{ Hz}), \text{ sine}$	$T_{VJ} = 125^{\circ}C$		980	A	
		$t = 8,3\text{ ms}; (60\text{ Hz}), \text{ sine}$	$V_R = 0\text{ V}$		1.06	kA	
$I^2t$	value for fusing	$t = 10\text{ ms}; (50\text{ Hz}), \text{ sine}$	$T_{VJ} = 45^{\circ}C$		6.62	kA <sup>2</sup> s	
		$t = 8,3\text{ ms}; (60\text{ Hz}), \text{ sine}$	$V_R = 0\text{ V}$		6.40	kA <sup>2</sup> s	
		$t = 10\text{ ms}; (50\text{ Hz}), \text{ sine}$	$T_{VJ} = 125^{\circ}C$		4.80	kA <sup>2</sup> s	
		$t = 8,3\text{ ms}; (60\text{ Hz}), \text{ sine}$	$V_R = 0\text{ V}$		4.63	kA <sup>2</sup> s	
$C_J$	junction capacitance	$V_R = 400\text{ V}$ $f = 1\text{ MHz}$	$T_{VJ} = 25^{\circ}C$		54	pF	
$P_{GM}$	max. gate power dissipation	$t_p = 30\text{ }\mu s$	$T_C = 125^{\circ}C$		10	W	
		$t_p = 300\text{ }\mu s$			5	W	
$P_{GAV}$	average gate power dissipation				0.5	W	
$(di/dt)_{cr}$	critical rate of rise of current	$T_{VJ} = 125^{\circ}C; f = 50\text{ Hz}$ repetitive, $I_T = 150\text{ A}$			150	A/ $\mu s$	
		$t_p = 200\text{ }\mu s; di_G/dt = 0.45\text{ A}/\mu s;$ $I_G = 0.45\text{ A}; V = \frac{2}{3} V_{DRM}$ non-repet., $I_T = 49\text{ A}$			500	A/ $\mu s$	
$(dv/dt)_{cr}$	critical rate of rise of voltage	$V = \frac{2}{3} V_{DRM}$ $R_{GK} = \infty; \text{ method 1 (linear voltage rise)}$	$T_{VJ} = 125^{\circ}C$		1000	V/ $\mu s$	
$V_{GT}$	gate trigger voltage	$V_D = 6\text{ V}$	$T_{VJ} = 25^{\circ}C$		1.5	V	
			$T_{VJ} = -40^{\circ}C$		1.6	V	
$I_{GT}$	gate trigger current	$V_D = 6\text{ V}$	$T_{VJ} = 25^{\circ}C$		100	mA	
			$T_{VJ} = -40^{\circ}C$		200	mA	
$V_{GD}$	gate non-trigger voltage	$V_D = \frac{2}{3} V_{DRM}$	$T_{VJ} = 125^{\circ}C$		0.2	V	
$I_{GD}$	gate non-trigger current				10	mA	
$I_L$	latching current	$t_p = 10\text{ }\mu s$	$T_{VJ} = 25^{\circ}C$		450	mA	
		$I_G = 0.45\text{ A}; di_G/dt = 0.45\text{ A}/\mu s$					
$I_H$	holding current	$V_D = 6\text{ V}$ $R_{GK} = \infty$	$T_{VJ} = 25^{\circ}C$		200	mA	
$t_{gd}$	gate controlled delay time	$V_D = \frac{1}{2} V_{DRM}$	$T_{VJ} = 25^{\circ}C$		2	$\mu s$	
		$I_G = 0.45\text{ A}; di_G/dt = 0.45\text{ A}/\mu s$					
$t_q$	turn-off time	$V_R = 100\text{ V}; I_T = 150\text{ A}; V = \frac{2}{3} V_{DRM}$ $di/dt = 10\text{ A}/\mu s$ $dv/dt = 20\text{ V}/\mu s$ $t_p = 200\text{ }\mu s$	$T_{VJ} = 100^{\circ}C$		150	$\mu s$	

Package TO-240AA				Ratings			
Symbol	Definition	Conditions	min.	typ.	max.	Unit	
$I_{RMS}$	RMS current	per terminal			200	A	
$T_{VJ}$	virtual junction temperature		-40		125	°C	
$T_{op}$	operation temperature		-40		100	°C	
$T_{stg}$	storage temperature		-40		125	°C	
<b>Weight</b>					81	g	
$M_D$	mounting torque		2.5		4	Nm	
$M_T$	terminal torque		2.5		4	Nm	
$d_{Spp/App}$	creepage distance on surface   striking distance through air	terminal to terminal	13.0	9.7		mm	
$d_{Spb/Apb}$		terminal to backside	16.0	16.0		mm	
$V_{ISOL}$	isolation voltage	t = 1 second			3600	V	
		t = 1 minute	50/60 Hz, RMS; $I_{ISOL} \leq 1$ mA		3000	V	

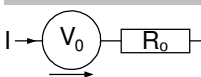

Ordering	Ordering Number	Marking on Product	Delivery Mode	Quantity	Code No.
Standard	MCC44-18io8B	MCC44-18io8B	Box	36	454532

**Equivalent Circuits for Simulation**
*\* on die level*
 $T_{VJ} = 125\text{ °C}$ 

**Thyristor**

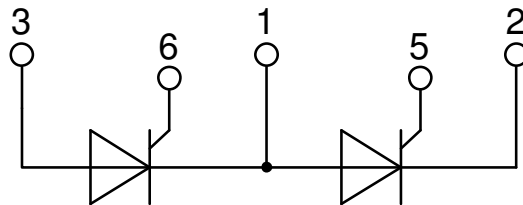
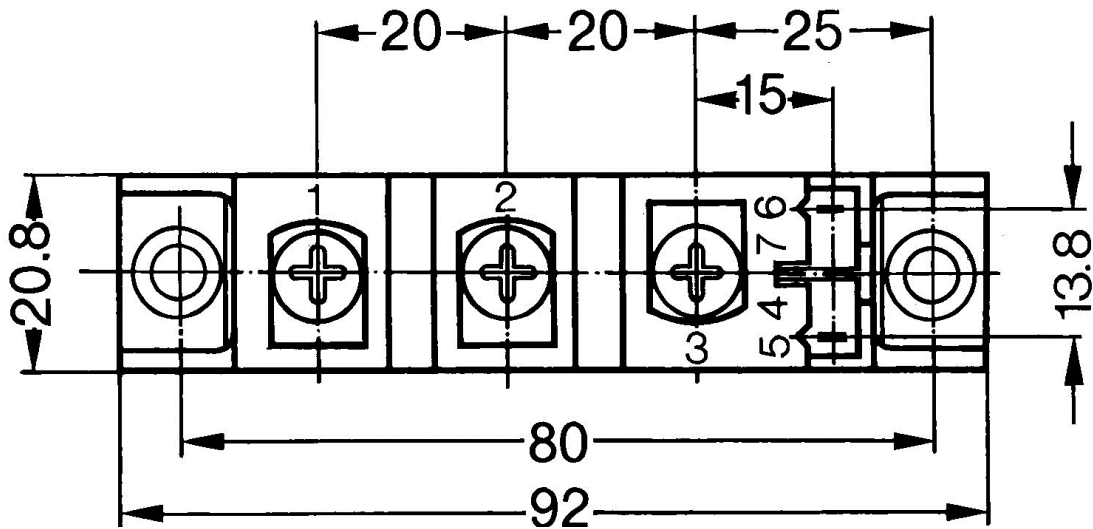
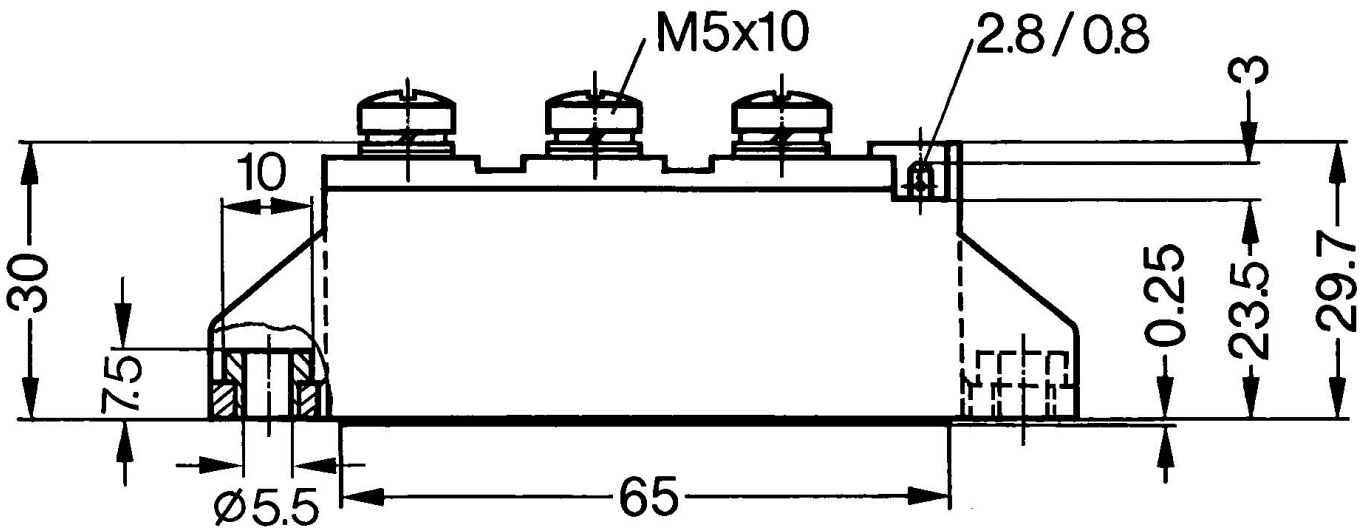
$V_{0\ max}$	threshold voltage	0.85	V
$R_{0\ max}$	slope resistance *	4.1	mΩ



## Thyristor

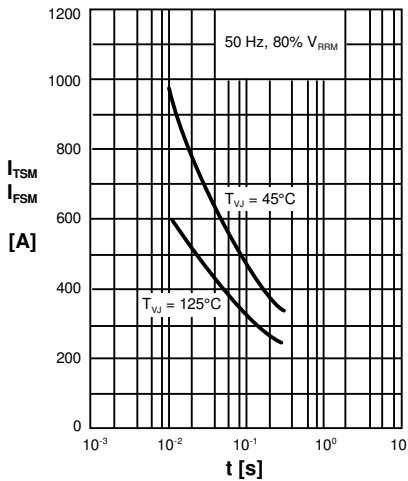

Fig. 1 Surge overload current  
 $I_{TSM}$ ,  $I_{FSM}$ : Crest value, t: duration

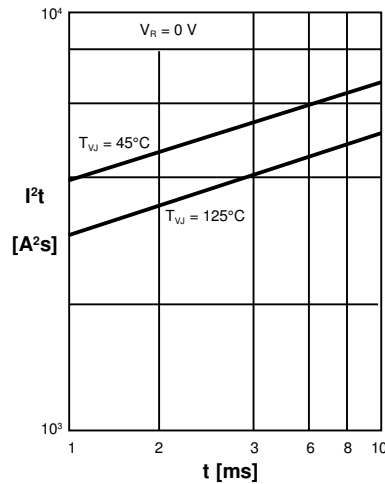

Fig. 2  $I^2t$  versus time (1-10 ms)

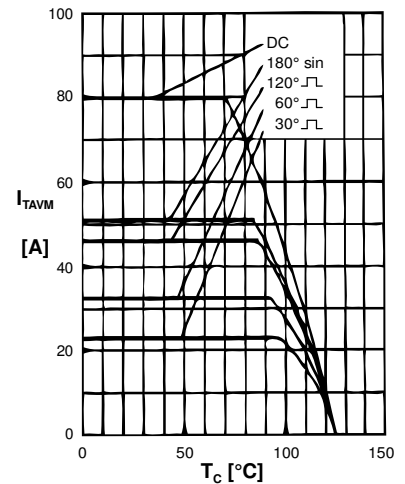

Fig. 3 Maximum forward current at case temperature

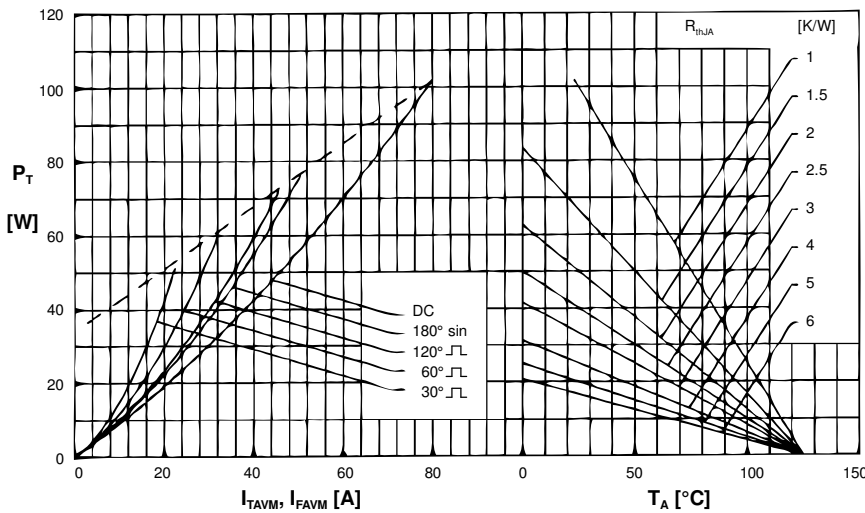

Fig. 4 Power dissipation vs. onstate current and ambient temperature (per thyristor/diode)

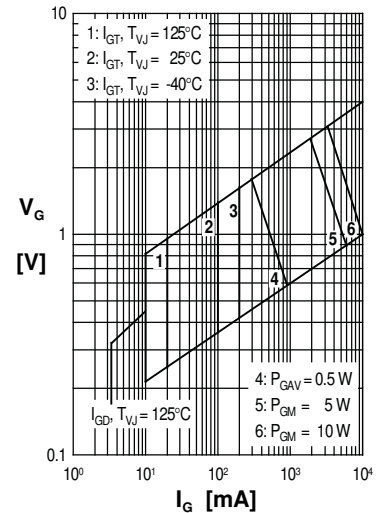

Fig. 5 Gate trigger characteristics

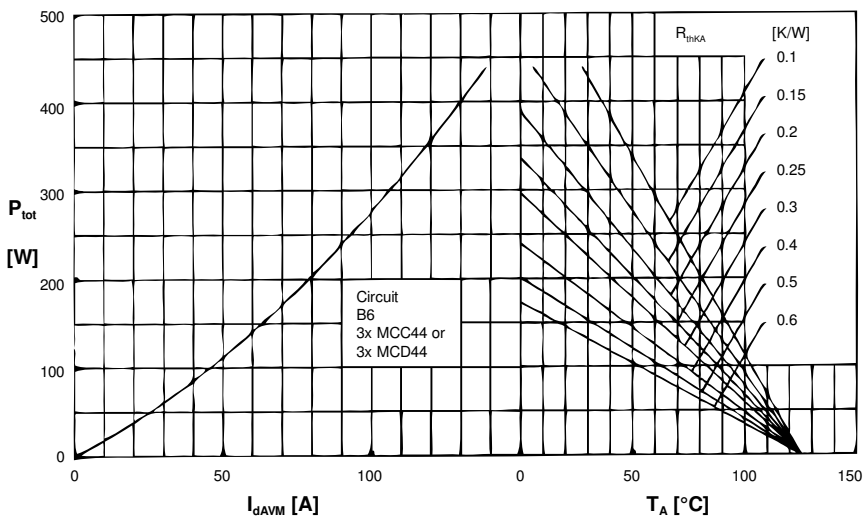

Fig. 6 Three phase rectifier bridge: Power dissipation versus direct output current and ambient temperature

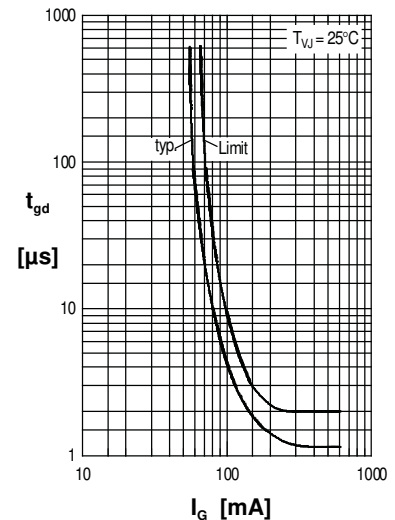

Fig. 7 Gate trigger delay time

Thyristor

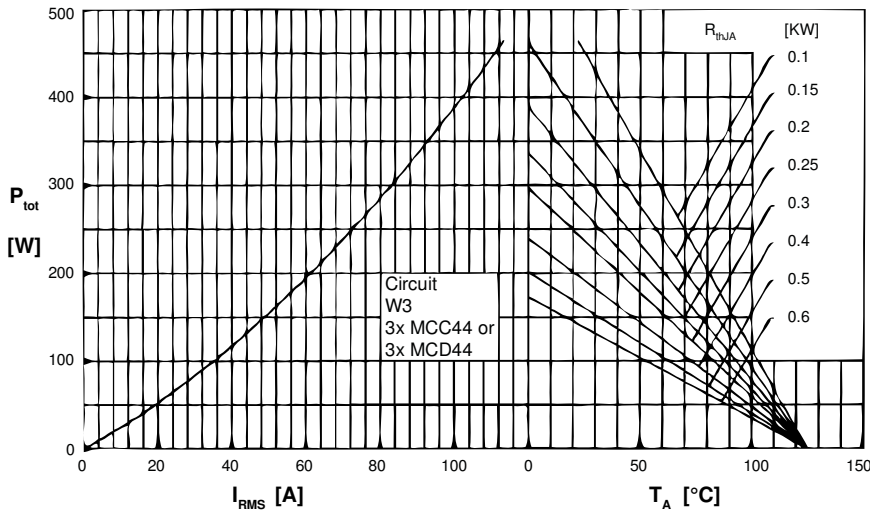

Fig. 8 Three phase AC-controller: Power dissipation versus RMS output current and ambient temperature

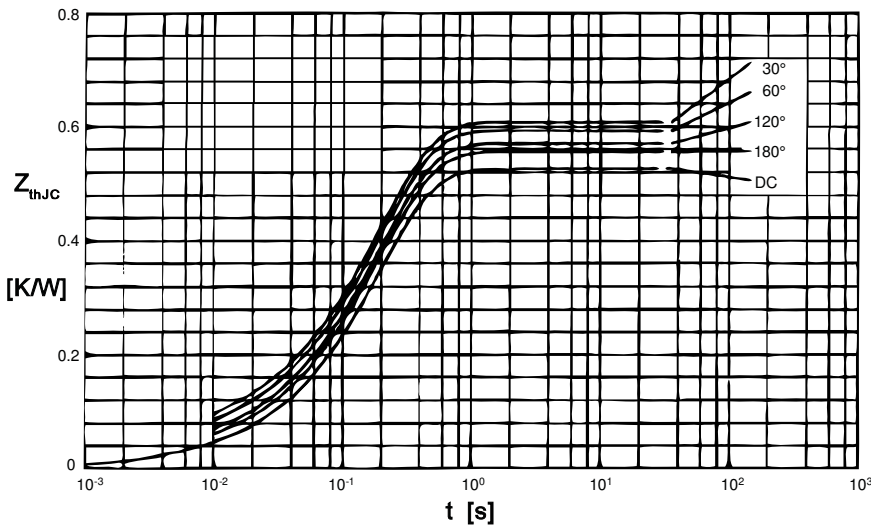

Fig. 9 Transient thermal impedance junction to case (per thyristor)

$R_{thJC}$  for various conduction angles d:

d	$R_{thJC}$ [KW]
DC	0.53
180°	0.55
120°	0.58
60°	0.60
30°	0.62

Constants for  $Z_{thJC}$  calculation:

i	$R_{thi}$ [KW]	$t_i$ [s]
1	0.015	0.0035
2	0.026	0.0200
3	0.489	0.1950

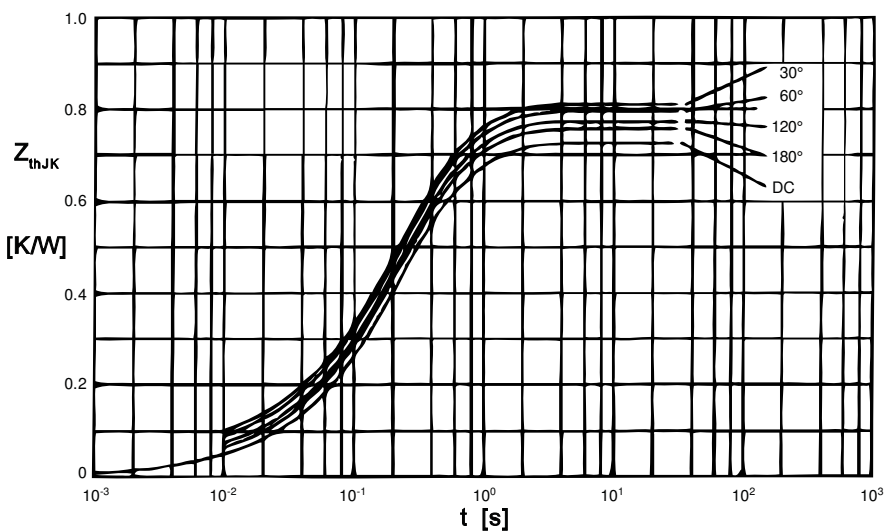

Fig. 10 Transient thermal impedance junction to heatsink (per thyristor)

$R_{thJK}$  for various conduction angles d:

d	$R_{thJK}$ [KW]
DC	0.73
180°	0.75
120°	0.78
60°	0.80
30°	0.82

Constants for  $Z_{thJK}$  calculation:

i	$R_{thi}$ [KW]	$t_i$ [s]
1	0.015	0.0035
2	0.026	0.0200
3	0.489	0.0195
4	0.200	0.6800