

PART No. 1447SE12

for more information visit

www.hammfg.com

Data subject to change without notice

Isometric drawing Not to Scale

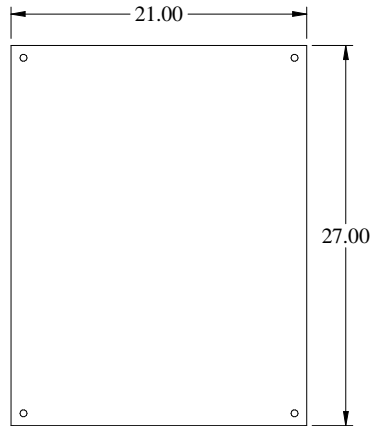

INNER PANEL

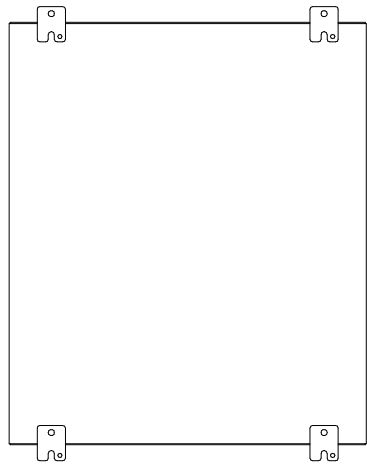

BACK VIEW

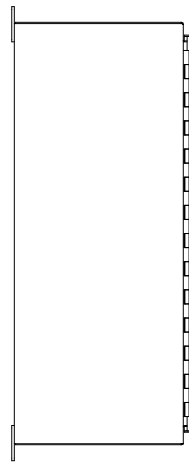

SIDE VIEW

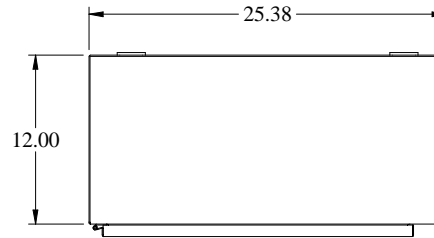

TOP VIEW

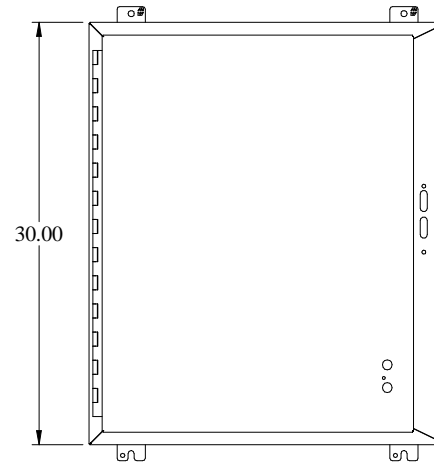

FRONT VIEW

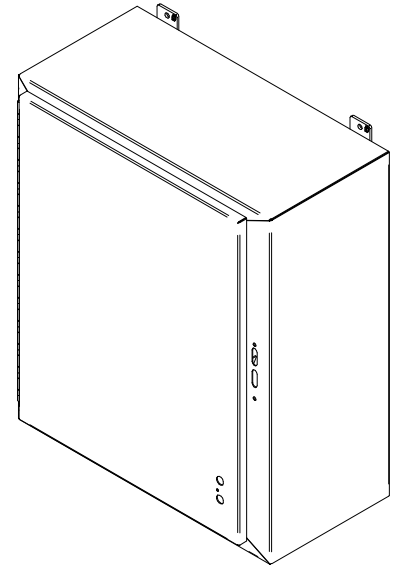

ISOMETRIC VIEW

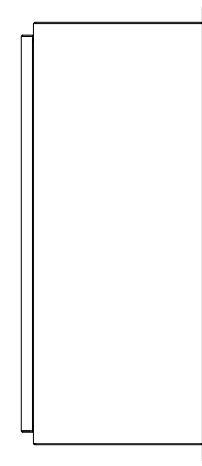

SIDE VIEW

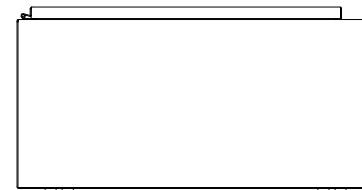

BOTTOM VIEW