

nRFgo nRF24LU1+ Flash/OTP Programming Adapter Kit

User Guide v1.1

Liability disclaimer

Nordic Semiconductor ASA reserves the right to make changes without further notice to the product to improve reliability, function or design. Nordic Semiconductor ASA does not assume any liability arising out of the application or use of any product or circuits described herein.

Life support applications

These products are not designed for use in life support appliances, devices, or systems where malfunction of these products can reasonably be expected to result in personal injury. Nordic Semiconductor ASA customers using or selling these products for use in such applications do so at their own risk and agree to fully indemnify Nordic Semiconductor ASA for any damages resulting from such improper use or sale.

Contact details

For your nearest dealer, please see <http://www.nordicsemi.no>

Receive available updates automatically by subscribing to eNews from our homepage or check our website regularly for any available updates.

Main office:

Otto Niensens veg 12
7004 Trondheim
Phone: +47 72 89 89 00
Fax: +47 72 89 89 89
www.nordicsemi.no



Revision History

Date	Version	Description
January 2012	1.1	Removed references to the CD
October 2009	1.0	User Guide

Contents

1	Introduction	4
1.1	Prerequisites	4
1.2	Writing Conventions	4
2	Kit content	5
3	System features	6
4	Hardware description	7
5	Programming.....	9
5.1	Program device in socket.....	9
5.2	Program devices through adapter module ISP connector	10
6	Troubleshooting	12
7	Appendix	13
7.1	Adapter module schematic	13
7.2	Adapter module Motherboard connectors	14
7.3	ISP interface connector	15

1 Introduction

The nRFgo nRF24LU1+ Flash/OTP Programming Adapter Kit in combination with the nRF6700 - nRFgo Starter Kit (sold separately) provides a complete solution for programming OTP/flash parts from Nordic Semiconductor in prototyping and small production pilot runs.

The adapter supports both programming of unmounted parts (socket) and in-system programming of parts mounted on external PCBs.

1.1 Prerequisites

To fully understand this User Guide a background in software development and/or electronic engineering is required. The nRFgo Starter Kit User Guide must also be read.

1.2 Writing Conventions

This user guide follows a set of typographic rules that makes the document consistent and easy to read. The following writing conventions are used:

- Pin names and commands are written in `Courier New` **bold**.
- File names and User Interface components are written in **bold**.
- Cross references are [underlined and highlighted in blue](#).

2 Kit content

The nRFgo nRF24LU1+ Flash/OTP Programming Adapter Kit contains the following hardware, software and documentation components.



Figure 1. Kit content

nRF24LU1+ Flash/OTP Programming Adapter Kit content:

- 1 Programming Adapter Module
- 1 Printed Getting Started Guide

3 System features

The nRFgo nRF24LU1+ Flash/OTP Programming Adapter (hereafter simply called adapter module) fits into the nRFgo Starter Kit Motherboard (nRF6310) extension port (EXT A/EXT B). The product's features are listed below:

- Enables programming of blank flash and OTP memory based parts
- Socket for programming of unmounted parts (Max. 5000 mechanical cycles)
- nRF ISP interface for programming of parts mounted on external PCB
- Easy-to-use configuration and programming GUI in nRFgo Studio

4 Hardware description

This section describes the different parts of the adapter module.

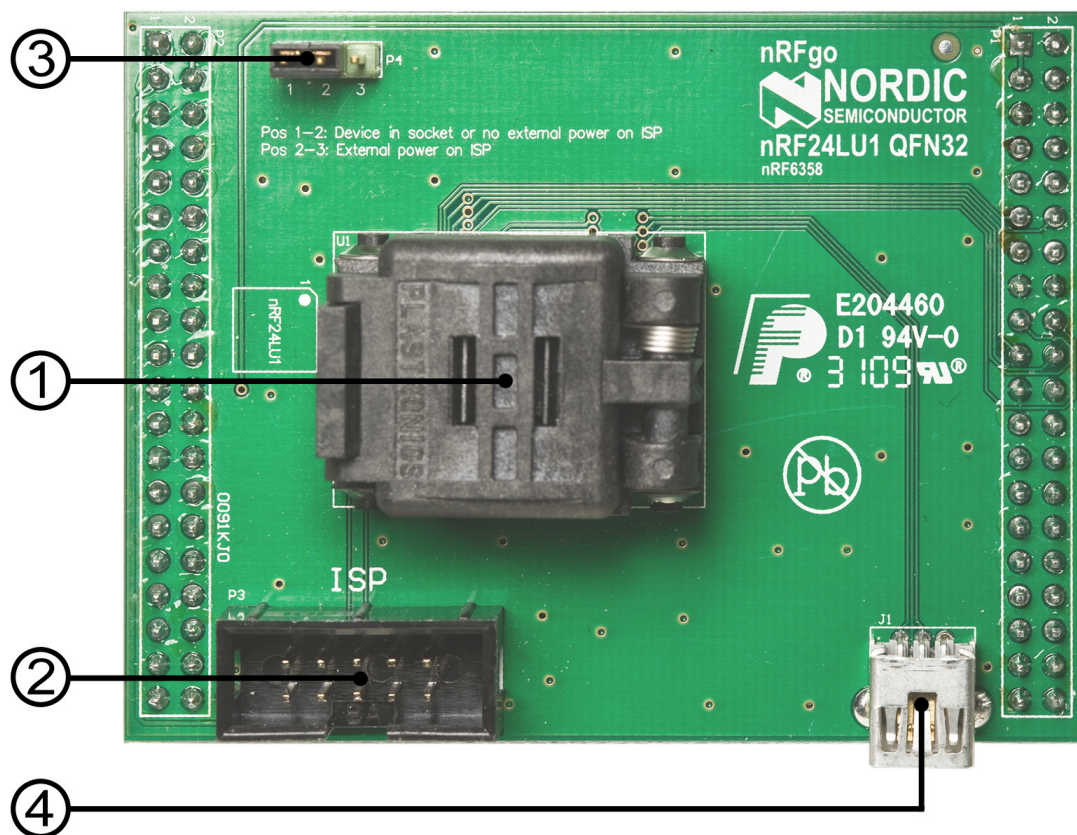

- | | |
|--|--|
| ① Programming socket (Max. 5000 mechanical cycles) | ③ Header (P4) for selecting between external/internal power supply on ISP connector (P3) |
| ② ISP interface connector (P3) | ④ USB connector (J1) for computer connection of the nRF24LU1+ device's USB interface. Can be used for device testing. ^a |

a. Please turn off power on the Motherboard before the USB (J1) is connected to the computer.

Figure 2. Adapter module for nRF24LU1+ (top view)

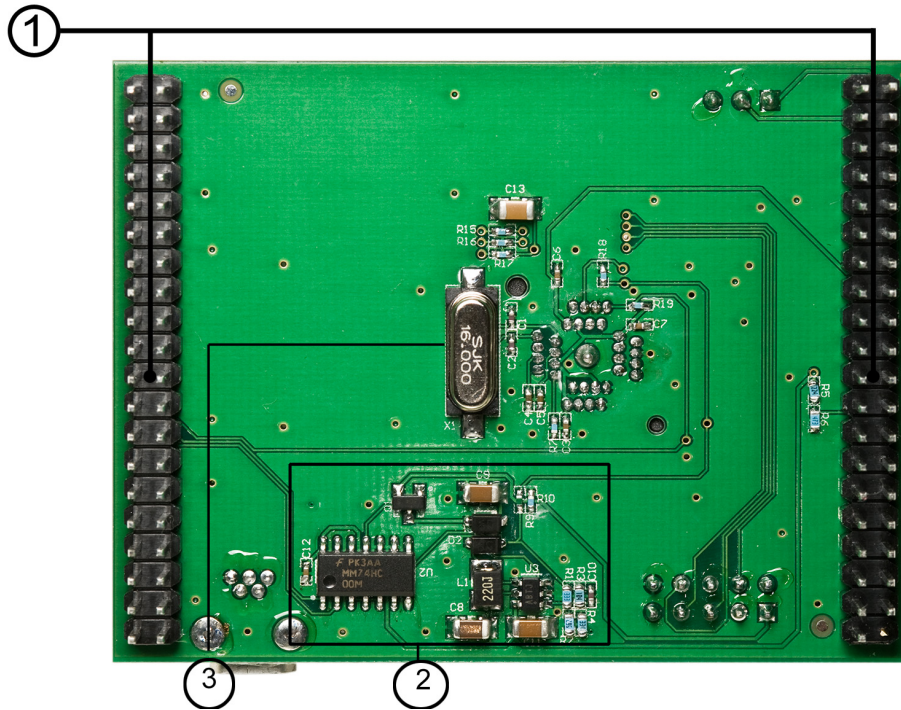

- ① nRFgo Motherboard interface connectors (P1 and P2)
- ② Crystal for reference clock during programming
- ③ 6.75V programming voltage generator

Figure 3. Adapter module for nRF24LU1+ (bottom view)

5 Programming

You can either program the device in the adapter module's socket or, if the device is already mounted on an external PCB, you can use the ISP (in-system programming) interface on connector P3.

5.1 Program device in socket

Before you program a device in the adapter module's socket, carry out the following steps.

1. Turn off the power of the nRFgo Motherboard (flip switch S9 to "OFF").
2. Set jumper in position 1-2 on header P4 on the adapter module. (Failing to set the jumper in the correct position may cause damage to the nRFgo Motherboard and/or the device to be programmed.)
3. Place the device into the socket. Ensure that the device has the correct orientation according to the printed diagram beside the socket (on the adapter board). See [Figure 6. on page 11](#).
4. Turn on the power of the nRFgo Motherboard (flip the switch S9 to "ON".) On your computer screen, you should now see an application dialog appear from nRFgo Studio. See [Figure 4. on page 9](#).

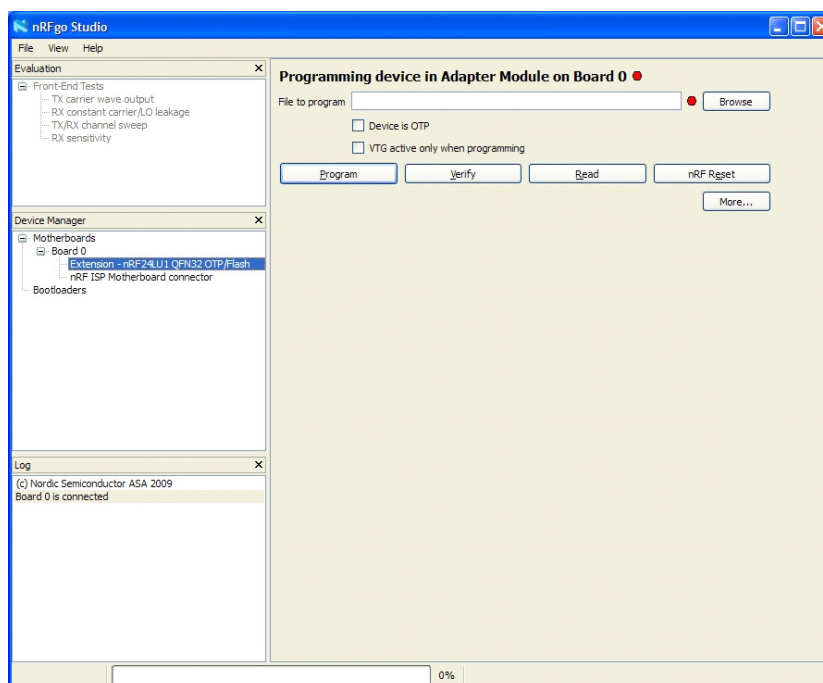

Figure 4. Main dialog for nRFgo Studio

5. In your nRFgo Studio user interface, mouse-click the “+” box to the left of “Board 0” in the “Device Manager” tree view to expand the node. Please see [Figure 5. on page 10.](#)

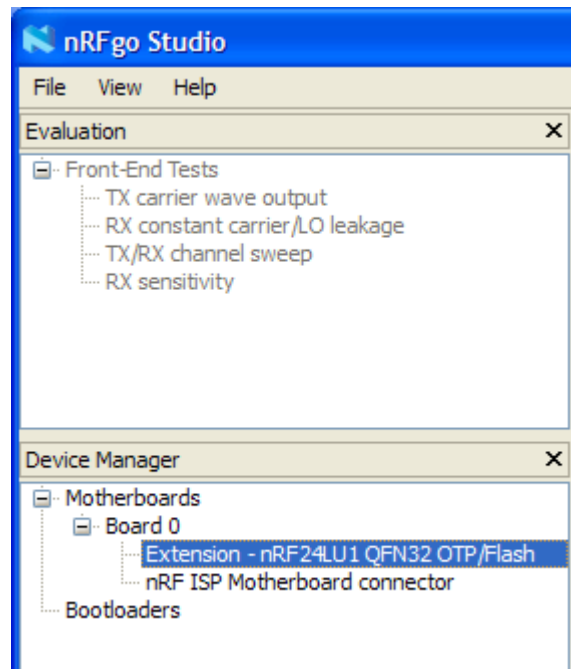

Figure 5. Device Manager field in nRFgo Studio interface

6. After having expanded the “Board 0” node, click on the “Extension” selection that appears in the “Device Manager” tree view. See [Figure 5.](#)
7. Now you can use the adapter module to program both OTP and Flash versions of the device. (Default target is the Flash version).
8. To enable programming of an OTP version, check the “Device is OTP” checkbox. By checking this selection, you ensure that the adapter changes its programming voltage automatically to 6.75V. This must not be done on flash devices. Please refer to the help file in nRFgo Studio for further information on how to one-time program a device in the programming socket.
9. Multi-programming of Flash/OTP devices is possible if the “VTG active only when programming” checkbox is checked. With this feature active, the VTG (device target voltage supply) is turned off after each programming cycle, making it safe to replace the programmed device with a new one.

5.2 Program devices through adapter module ISP connector

In order to program a device mounted on an external PCB, you must use the ISP connector (P3) on the adapter module, and carry out the steps described in this section.

1. Turn off the power of the nRFgo Motherboard (flip switch S9 to “OFF”).
2. Use header P4 on the adapter module to select between external or internal power on the ISP connector, P3.
 - ▶ **[External]** If the device runs on its own power from the external PCB, ensure that a jumper is connected between pin 3 and 2 on header P4. Programming of a device in the socket is not possible when the jumper is in this position. Failing to set the jumper in the correct position may cause damage to the nRFgo Motherboard and/or the device to be programmed.

- ▶ **[Internal]** If the external PCB for the device to be programmed does not have its own power supply, set the jumper in position 1-2. The nRFgo Motherboard will now supply power to the device through the ISP connector.

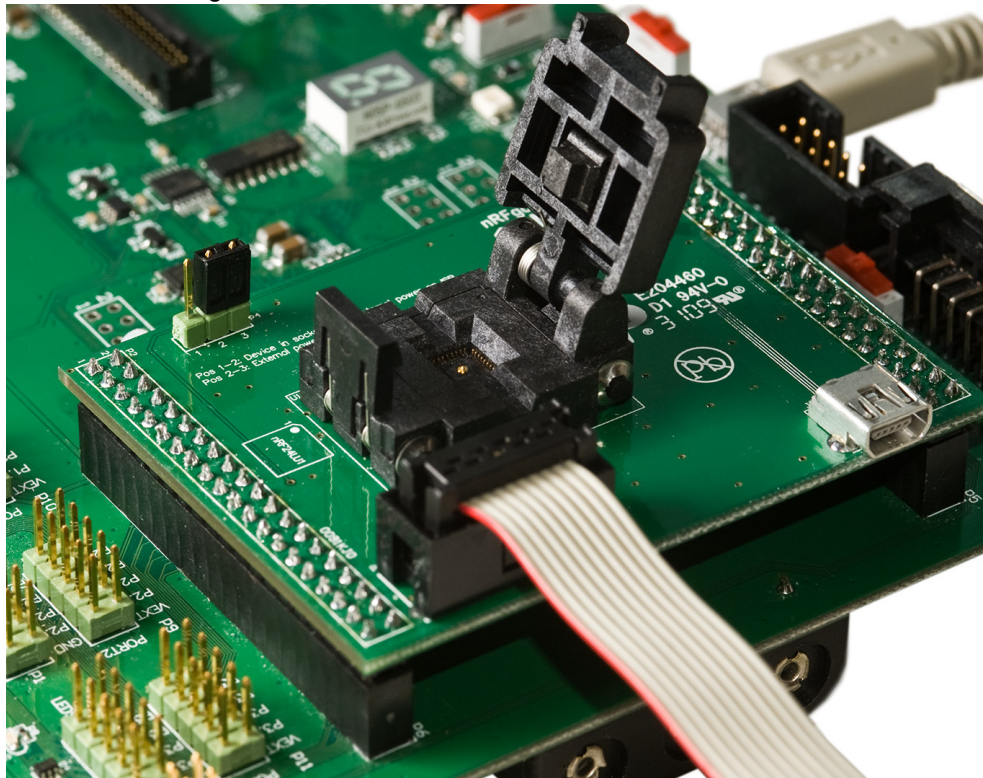

Figure 6. Jumper in position 2-3 on header P4

3. Turn on the power of the nRFgo Motherboard (flip the switch S9 to “ON”.) On your computer screen, you should now see an application dialog appear from nRFgo Studio. See [Figure 4. on page 9.](#)
4. In your nRFgo Studio user interface, mouse-click the “+” box to the left of “Board 0” in the “Device Manager” tree view to expand the node. Please see [Figure 5. on page 10.](#)
5. After having expanded the “Board 0” node, click on the “Extension” selection that appears in the “Device Manager” tree view. See [Figure 5. on page 10.](#)
6. Now you can use the adapter module to program both OTP and Flash versions of the device. (Default target is the Flash version).
7. To enable programming of an OTP version, check the “Device is OTP” checkbox. By checking this selection, you ensure that the adapter changes its programming voltage automatically to 6.75V. **This must not be done on flash devices.** Please refer to the help file in nRFgo Studio for further information on how to one-time program a device in the programming socket.
8. Multi-programming of Flash/OTP devices is possible if the “VTG active only when programming” checkbox is checked. With this feature active, the VTG (device target voltage supply) is turned off after each programming cycle, making it safe to replace the programmed device with a new one.

6 Troubleshooting

The adapter module doesn't appear in the nRFgo Studio when it is plugged into the nRFgo Motherboard. What has happened?

- Ensure that the nRFgo Motherboard is present in the nRFgo Studio. If not, refer to the troubleshooting chapter of the nRFgo Starter Kit User Guide.
- Make sure there is no nRF module present in the Motherboard's slots MOD A and MOD B.

I am trying to perform program a device in the socket, but I can't. What has happened?

- Make sure the device is correctly oriented in the socket; see the printed diagram beside the socket.
- Make sure the jumper on header P4 is set in position 1-2.

I am trying to program a device on an external PCB, but I can't. I don't have a power supply on the external PCB. What has happened?

- Make sure the cable's connector between the external PCB and the adapter module has the correct pinout (ISP connector pinout). See [section 7.3 on page 15](#).
- Make sure the jumper on header P4 is set in position 1-2.
- Make sure there is no device present in the socket.

I am trying to program a device on an external PCB, but I can't. I have a separate power supply on the external PCB. What has happened?

- Make sure the cable's connector between the external PCB and the adapter module has the correct pinout (ISP connector pinout). See [section 7.3 on page 15](#).
- Make sure the jumper on header P4 is set in position 2-3.
- Make sure there is no device present in the socket.

7 Appendix

7.1 Adapter module schematic

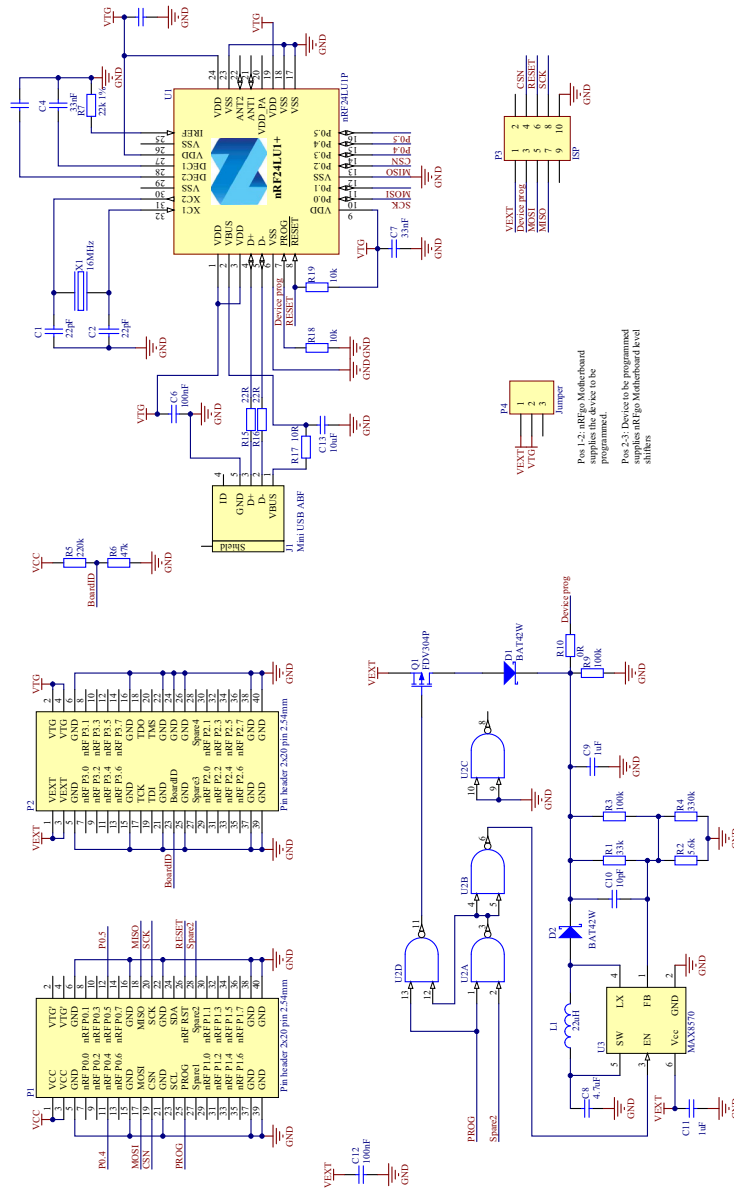

Figure 7. Schematic, nRF24LU1+, nRF6358

7.2 Adapter module Motherboard connectors

The adapter module connectors, P1 and P2, have all the I/Os required for communicating with the nRFgo Motherboard. All nRF24LU1+ device GPIOs are available on the PortX connectors on the nRFgo Motherboard, except the flash SPI lines.

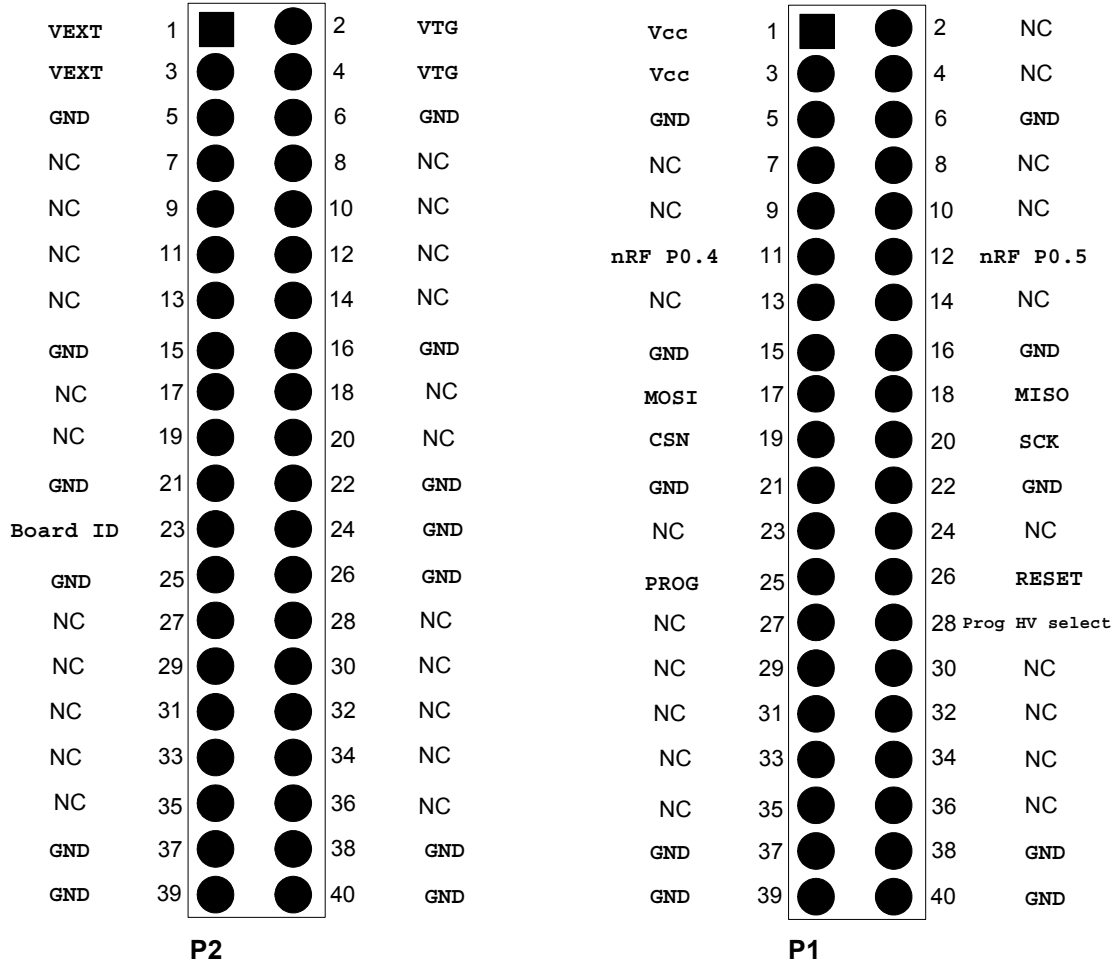

Figure 8. Adapter module connectors, nRF24LU1+, nRF6358

7.3 ISP interface connector

A nRF ISP interface connector (P3) is available on the adapter module to enable in-circuit programming (ISP) of nRF devices. This interface enables ISP on your application boards. [Figure 9](#) shows the pinout of the ISP connector. Please refer to nRF device product specifications for details on the program interface pinout on each nRF device.

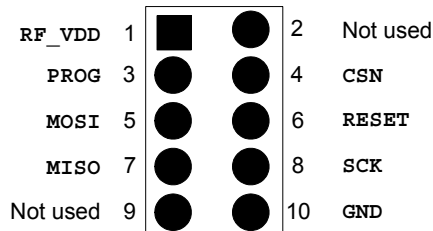

Figure 9. nRF ISP interface

Pin number	Signal name	Description
1	RF_VDD	Supply voltage from the connected application board
2		Not used
3	PROG	Program enable
4	CSN	SPI chip select
5	MOSI	SPI Master Out Slave In
6	RESET	Reset signal to the device to be programmed
7	MISO	SPI Master In Slave Out
8	SCK	SPI clock
9		Not used
10	GND	Common ground

Table 1. ISP interface connector pin description